

INSTRUCTION MANUAL

**7A18/7A18N
DUAL TRACE
AMPLIFIER**

Serial No. B127452

Scans By *Artek Media*

Artek Media
1042 Plummer Cir. SW
Rochester, MN 55902

www.artekmedia.com

“High resolution scans of obsolete technical manuals”

If your looking for a quality scanned technical manual in PDF format please visit our WEB site at www.artekmedia.com or drop us an email at manuals@artekmedia.com and we will be happy to email you a current list of the manuals we have available.

If you don't see the manual you need on the list drop us a line anyway we may still be able to point you to other sources. If you have an existing manual you would like scanned please write for details, This can often be done very reasonably in consideration for adding your manual to our library.

Typically the scans in our manuals are done as follows;

- 1) Typed text pages are typically scanned in black and white at 300 dpi.
- 2) Photo pages are typically scanned in gray scale mode at 600 dpi
- 3) Schematic diagram pages are typically scanned in black and white at 600 dpi unless the original manual had colored high lighting (as is the case for some 70's vintage Tektronix manuals).

If you purchased this manual from us (typically through our Ebay name of ArtekMedia) thank you very much. If you received this from a well-meaning “friend” for free we would appreciate your treating this much like you would “share ware”. By that we mean a donation of at least \$5-10 per manual is appreciated in recognition of the time (a manual can take as much as 40 hours to reproduce, book, link etc.), energy and quality of effort that went into preserving this manual. Donations via PayPal go to: manuals@artekmedia.com or can be mailed to us the address above.

Thanks



Dave & Lynn Henderson
Artek Media



WARRANTY

All TEKTRONIX instruments are warranted against defective materials and workmanship for one year. Any questions with respect to the warranty should be taken up with your TEKTRONIX Field Engineer or representative.

All requests for repairs and replacement parts should be directed to the TEKTRONIX Field Office or representative in your area. This will assure you the fastest possible service. Please include the instrument Type Number or Part Number and Serial Number with all requests for parts or service.

Specifications and price change privileges reserved.

Copyright © 1971, new material 1974, by Tektronix, Inc., Beaverton, Oregon. Printed in the United States of America. All rights reserved. Contents of this publication may not be reproduced in any form without permission of Tektronix, Inc.

U.S.A. and foreign TEKTRONIX products covered by U.S. and foreign patents and/or patents pending.

TEKTRONIX is a registered trademark of Tektronix, Inc.

TABLE OF CONTENTS

SECTION 1	SPECIFICATION	Page	OPTION INFORMATION
	Introduction	1-1	
	Electrical Characteristics	1-1	SECTION 6 ELECTRICAL PARTS LIST
	7A18 And Mainframe Frequency Response	1-3	Abbreviations and Symbols
	Environmental Characteristics	1-3	Parts Ordering Information
	Physical Characteristics	1-3	
SECTION 2	OPERATING INSTRUCTIONS		SECTION 7 DIAGRAMS AND CIRCUIT BOARD ILLUSTRATIONS
	Installation	2-1	Symbols and Reference Designators
	Front Panel Controls and Connectors	2-1	Voltage and Waveform Conditions
	General Operating Information	2-2	
	Basic Applications	2-4	
SECTION 3	CIRCUIT DESCRIPTION		SECTION 8 MECHANICAL PARTS LIST
	Introduction	3-1	Mechanical Parts List Information
	Block Diagram Description	3-1	Index of Mechanical Parts Illustrations
	Detailed Circuit Description	3-1	Mechanical Parts List
SECTION 4	MAINTENANCE		Accessories
	Preventive Maintenance	4-1	
	Troubleshooting	4-1	
	Replacement Parts	4-3	CHANGE INFORMATION
	Component Replacement	4-4	
SECTION 5	CALIBRATION		Abbreviations and symbols used in this manual are based on or taken directly from IEEE Standard 260 "Standard Symbols for Units", MIL-STD-12B and other standards of the electronics industry. Change information, if any, is located at the rear of this manual.
	Recalibration Interval	5-1	
	Test Equipment Required	5-1	
	Part I — Performance Check	5-3	
	Part II — Adjustment	5-7	

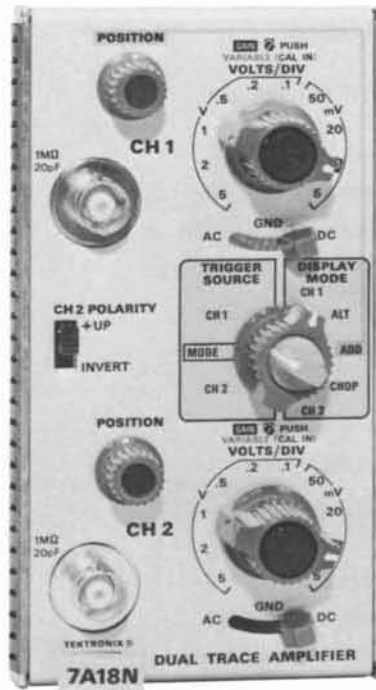
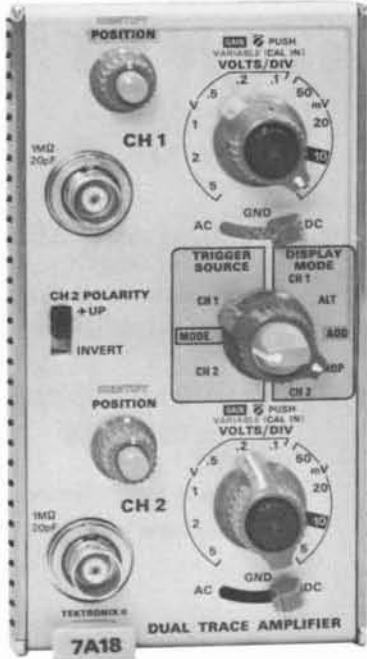

Fig. 1-1. 7A18 and 7A18N Amplifier.

SECTION 1

SPECIFICATION

Change information, if any, affecting this section will be found at the rear of the manual.

Introduction

The 7A18 and 7A18N Dual Trace Amplifier plug-in units are designed for use with Tektronix 7000-Series Oscilloscopes. The 7A18 and 7A18N are electrically identical except that readout encoding capabilities and an "IDENTIFY" function are provided only in the 7A18. All references made to the 7A18 apply equally to the 7A18N unless otherwise noted. The 7A18 is a dual-channel, medium-bandwidth amplifier. Internal gain and compensation circuits are automatically switched to correspond to

the setting of the VOLTS/DIV switch. Channel 2 can be inverted for differential measurements. The 7A18 can be operated in any plug-in compartment of the 7000-Series Oscilloscopes.

The following electrical characteristics are valid over the stated environmental range for instruments calibrated at an ambient temperature of +20°C to +30°C, and after a five minute warmup unless otherwise noted.

TABLE 1-1
ELECTRICAL

Characteristic	Performance Requirement	Supplemental Information
Deflection Factor		
Calibrated Range	5 mV/Div to 5 V/Div; ten steps in a 1, 2, 5 sequence.	
Deflection Factor Accuracy	Within 2% with GAIN adjusted at 10 mV/Div.	
Uncalibrated (VARIABLE)	Continuously variable between calibrated steps; extends deflection factor to at least 12.5 V/Div.	
GAIN		Permits adjustment of deflection factor for calibrated operation with all 7000-series oscilloscopes.
Frequency Response System Dependent (8 div reference signal)		
Upper Bandwidth DC (Direct) Coupled	See Table A	
Lower Bandwidth AC (Capacitive) Coupled	10 Hertz or less	
With 10X Probe	1 Hertz or less	

TABLE 1-1 (cont)

Characteristic	Performance Requirement	Supplemental Information
Maximum Input Voltage		
DC Coupled		250 volts, (DC + Peak AC); AC component 500 volts peak-to-peak maximum, one kilohertz or less.
AC Coupled		500 volts, (DC + Peak AC); AC component 500 volts peak-to-peak maximum, one kilohertz or less.
Channel Isolation	50:1 display ratio up to 50 megahertz.	
Input R and C		
Resistance	1 M Ω \pm 2%	
Capacitance	Approximately 20.0 pf	
RC Product		Within \pm 1% between all deflection factors.
Displayed Noise (Tangentially Measured)		300 microvolts or less at 5 mV/Div in 7000-Series Oscilloscope.
Overdrive Recovery Time		0.1 ms or less to recover to within one division after the removal of an overdrive signal of up to +75 divisions or -75 divisions regardless of overdrive signal duration.
Common Mode Rejection Ratio	At least 10:1 up to 50 megahertz.	
DC Drift		
Drift with Time (ambient temperature and line voltage constant)		0.02 division or less in any one minute, after one hour warmup.
Drift with Temperature (line voltage constant)		No more than 0.01 division per degree C.
Time Delay between Channels		700 picoseconds or less.
Display Modes	Channel 1 only. Dual-trace, alternate between channels. Added algebraically. Dual-trace chopped between channels. Channel 2 only.	

TABLE 1-1 (cont)

Characteristic	Performance Requirement	Supplemental Information
Trigger source Selection	Channel 1 only. Follows DISPLAY MODE selection. Channel 2 only.	

TABLE A
7A18 AND MAINFRAME
FREQUENCY RESPONSE

With 7700 Series 75 MHz	With 7500 Series 60 MHz	With 7400 Series 50 MHz
----------------------------	----------------------------	----------------------------

TABLE 1-2
ENVIRONMENTAL CHARACTERISTIC

Refer to the Specification for the associated oscilloscope.

TABLE 1-3
PHYSICAL

Size	Fits all 7000-series plug-in compartments.
Weight	2 Pounds 10 Ounces (1.4 kilograms)

SECTION 2

OPERATING INSTRUCTIONS

Change information, if any, affecting this section will be found at the rear of the manual.

General

To effectively use the 7A18, the operation and capabilities of the instrument must be known. This section describes front-panel control functions, general information on signal input connections, and other subjects that pertain to various measurement applications.

Installation

The 7A18 is calibrated and ready for use as received. It can be installed in any compartment of Tektronix 7000-Series oscilloscopes, but is intended for principal use in vertical plug-in compartments. To install, align the upper and lower rails of the 7A18 with the oscilloscope tracks and fully insert it. The front will be flush with the front of the oscilloscope when the 7A18 is fully inserted, and the latch at the bottom-left corner of the 7A18 will be in place against the front panel.

To remove the 7A18, pull on the latch (which is inscribed with the unit identification "7A18" or "7A18N") and the 7A18 will unlatch. Continue pulling on the latch to slide the 7A18 out of the oscilloscope.

FRONT PANEL CONTROLS AND CONNECTORS

The following descriptions apply to the controls and connectors of both Input Amplifier channels when applicable. See Fig. 2-1.

Input Connector	Provides signal connection to the channel.
AC-GND-DC	Selects signal input coupling mode. AC—The AC component of the signal is coupled to the amplifier input while the DC component is blocked. GND—Grounds the amplifier input while maintaining the same load for the input signal. Provides a charge path for the AC coupling capacitor to precharge the input circuit before switching the input to AC.

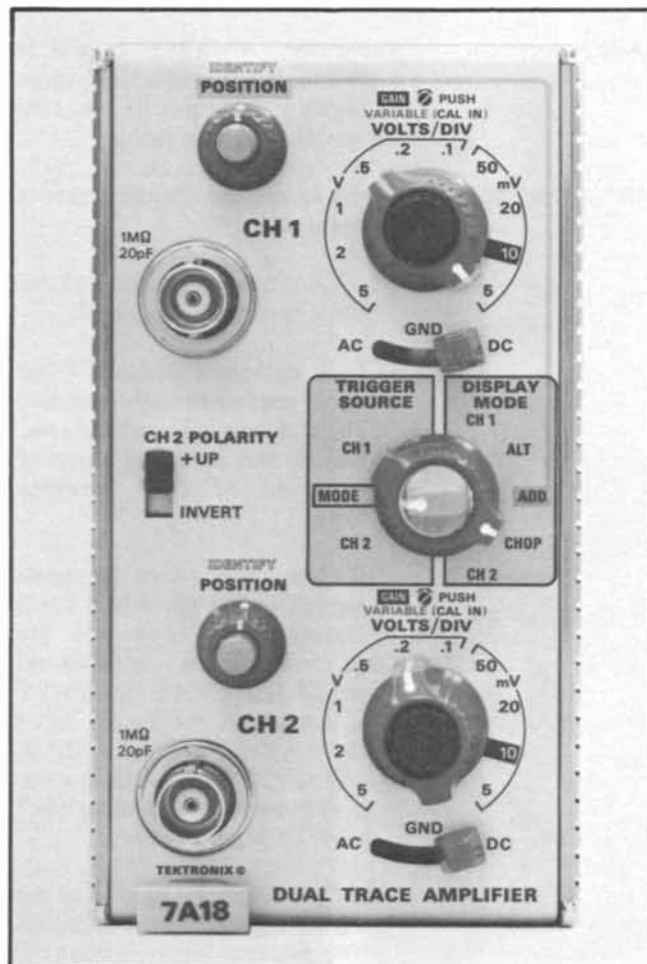

Fig. 2-1. Front-panel controls and connectors. (7A18 shown.)

DC	Both AC and DC components of the signal are coupled to the amplifier input.
POSITION	Controls position of the trace. Positioning of the trace in the "ADD" Display Mode is controlled by CH 1 POSITION control only.
IDENTIFY (7A18 only)	Deflects trace about 0.2 division for trace identification. In instruments with readout, also replaces readout with the word "IDENTIFY".

Operating Instructions—7A18/7A18N

VOLTS/DIV	Selects calibrated deflection factors from 5 mV/Div to 5 V/Div; ten steps in a 1-2-5 sequence.	CHOP display modes, the trigger signal is the algebraic sum of CH 1 and CH 2 trigger.
VARIABLE (VOLTS/DIV)	Provides continuously variable uncalibrated settings between calibrated steps. Extends the deflection factor range to 12.5 volts/division or more.	CH 2—Internal trigger signal obtained from signal applied to CH 2.
GAIN Adjustment	When the VARIABLE control is pushed in, it becomes a front-panel screw-driver adjustment for calibration of deflection factor.	CH 2 POLARITY Provides means of inverting the CH 2 display. +UP—A positive-going signal at the CH 2 input connector deflects the CRT display upward.
DISPLAY MODE	Selects one of the following modes of operation: CH 1—A single-trace display of the signal applied to Channel 1. ALT—A dual-trace display of the signal applied to both channels. The channels are alternately displayed, and switching occurs at the end of each time-base sweep. ADD—Algebraically adds the signals applied to the CH 1 and CH 2 input connectors, and the algebraic sum is displayed on the CRT. The CH 2 POLARITY switch allows the display to be CH 1 + CH 2 or CH 1 - CH 2. Position of the trace in this display mode is controlled by CH 1 POSITION control only. CHOP—A dual-trace display of the signals applied to both channels. The two channels time-share the sweep as determined by the indicator oscilloscope. CH 2—A single-trace display of the signal applied to CH 2.	INVERT—A positive-going signal at the CH 2 input connector deflects the CRT display downward.
TRIGGER SOURCE	Selects source of the trigger signal. The trigger signals provide internal triggering for the oscilloscope time-base units. CH 1—Internal triggering signal obtained from signal applied to CH 1. MODE—Internal trigger signal automatically follows DISPLAY MODE selection. In ADD or	

GENERAL OPERATING INFORMATION

Introduction

For single-trace operation, either of the two identical amplifier channels can be used independently by setting the DISPLAY MODE and TRIGGER SOURCE switches to CH 1 or CH 2 and connecting the signal to be observed to the appropriate input. In the discussions to follow, single-trace operations using CH 1 only apply equally to CH 2 only.

Signal Connections

In general, probes offer the most convenient means of connecting a signal to the input of the 7A18. A 10X attenuator probe offers a high input impedance and allows the circuit under test to perform very close to normal operating conditions.

The Tektronix P6053A probe, with its readout coding ring, was designed specifically for use with Tektronix 7A-series amplifier units equipped with readout. The readout coding ring on the probe connects to a circuit in the amplifier unit which automatically corrects the readout displayed on the CRT to the actual deflection factor at the tip of the probe being used. For probes to be used with amplifier units without readout, see the Tektronix, Inc. catalog.

Vertical Gain Check and Adjustment

To check the gain of either channel, set the VOLTS/DIV switch to 10 mV and connect 40 mV, 1 kHz signal from the oscilloscope calibrator to the input connector of the channel being checked. The vertical deflection should be exactly four divisions. If not, adjust the front-panel GAIN for exactly four divisions of deflection. The GAIN adjustment is engaged by pressing in the GAIN control knob and turning the knob with a narrow-blade screwdriver (see Front

Panel Controls and Connectors). Turn the knob clockwise, then counterclockwise, until the GAIN control is engaged. When the GAIN control is engaged, the vertical deflection will change as the knob is turned. Turn the GAIN control knob with the screwdriver until the deflection is set to exactly four divisions, then remove the screwdriver.

Input Coupling

The Channel 1 and Channel 2 coupling (AC-GND-DC) switches allow a choice of input coupling methods. The type of display desired and the applied signal will determine the coupling to use.

The DC coupling position must be used to display the DC component of the signal. It must also be used to display AC signals below about 30 hertz (ten hertz with a 10X probe) and square waves with low-frequency components as these signals are attenuated in the AC position.

In the AC coupling position, the DC component of the signal is blocked by a capacitor in the input circuit. The AC coupling position provides the best display of signals with a DC component much larger than the AC components. The precharge feature should be used with large DC inputs. To use this feature, first set the coupling to GND. Connect the probe to the circuit and wait about two seconds for the coupling capacitor to charge. Then set the coupling to AC.

The GND position provides a ground reference at the input of the amplifier without externally grounding the input connectors. However, the signals connected to the inputs are not grounded, and the same DC load is presented to the signal source.

VOLTS/DIV and VARIABLE Controls

The amount of vertical deflection produced by a signal is determined by the signal amplitude, the attenuation factor of the probe, the setting of the VOLTS/DIV switch, and the setting of the VARIABLE control. Calibration deflection factors indicated by the settings of the VOLTS/DIV switch apply only when the VARIABLE control is in the calibrated (CAL IN) position.

The VARIABLE control provides variable, uncalibrated settings between the calibrated steps of the VOLTS/DIV switch. With the VARIABLE control fully counterclockwise and the VOLTS/DIV set to 5 volts/div the uncalibrated vertical deflection factor is extended to at least 12.5 volts/division. By applying a calibrated voltage source to the input connector, any specific deflection factor can be set within the range of the VARIABLE control.

CH 2 POLARITY Switch

The CH 2 POLARITY switch may be used to invert the displayed waveform of the signal applied to the CH 2 input. This is particularly useful in added operation of the 7A18 when differential measurements are to be made. The CH 2 POLARITY switch has two positions, +UP and INVERT. In the +UP position, the displayed waveform will have the same polarity as the applied signal and a positive DC voltage will move the CRT trace up. In the INVERT position, a positive-going waveform at the CH 2 input will be displayed on the CRT in inverted form and a positive DC voltage will move the trace down.

DISPLAY MODE Switch

For single-trace operation, apply the signal either to the CH 1 input or the CH 2 input and set the DISPLAY MODE switch to the corresponding position: CH 1 or CH 2.

To display a signal in one channel independently when a signal is also applied to the other channel, simply select the desired channel by setting the DISPLAY MODE switch to the appropriate CH 1 or CH 2 position.

Alternate Mode. The ALT position of the DISPLAY MODE switch produces a display which alternates between channel 1 and channel 2 with each sweep on the CRT. Although the ALT mode can be used at all sweep rates, the CHOP mode provides a more satisfactory display at sweep rates below about 0.2 millisecond/division. At slow sweep rates alternate mode switching becomes visually perceptible.

Add Mode. The ADD position of the DISPLAY MODE switch can be used to display the sum or difference of two signals, for common-mode rejection to remove an undesired signal, or for DC offset (applying a DC voltage to one channel to offset the DC component of a signal on the other channel). The overall deflection factor in the ADD mode with both VOLTS/DIV switches set to the same position is the deflection factor indicated by either VOLTS/DIV switch. However, if the CH 1 and CH 2 VOLTS/DIV switches are set to different deflection factors, the resultant amplitude is difficult to determine from the CRT display. In this case, the voltage amplitude of the resultant display can be determined accurately only if the amplitude of the signal applied to one channel is known. In the ADD mode, positioning of the trace is controlled by the channel 1 POSITION control only.

Chop Mode. The CHOP position of the DISPLAY MODE switch produces a display which is electronically switched between channels at approximately a 500 kilohertz rate (controlled by mainframe). In general the CHOP mode provides the best display at sweep rates slower than

Operating Instructions—7A18/7A18N

about 0.2 millisecond/division or whenever dual-trace, non-repetitive phenomena is to be displayed.

TRIGGER SOURCE Switch

CH 1. The CH 1 position of the TRIGGER SOURCE switch provides a trigger signal obtained from the signal applied to the CH 1 input connector. This provides a stable display of the signal applied to the CH 1 input connector.

CH 2. The CH 2 position of the TRIGGER SOURCE switch provides a trigger signal obtained from the signal applied to the CH 2 input connector. This provides a stable display of the signal applied to the CH 2 input connector.

MODE. In this position of the TRIGGER SOURCE switch, the trigger signal for the time-base unit is dependent on the setting of the DISPLAY MODE switch. The trigger source for each position of the DISPLAY MODE switch is as follows:

MODE	TRIGGER SIGNAL SOURCE
CH 1	Channel 1
CH 2	Channel 2
ADD	Algebraic sum of channel 1 and channel 2
CHOP	Algebraic sum of channel 1 and channel 2
ALT	Alternates between channel 1 and channel 2

Trace Identification (7A18 only)

When the IDENTIFY button is pressed, the trace is deflected about 0.2 division to identify the 7A18 trace. This feature is particularly useful when multiple traces are displayed. In instruments with readout, also replaces deflection factor readout with the word "IDENTIFY".

BASIC APPLICATIONS

General

The following information describes the procedures and techniques for making basic measurements with a 7A18 and the associated Tektronix oscilloscope and time-base. These applications are not described in detail since each application must be adapted to the requirements of the individual measurements. This instrument can also be used for many applications not described in this manual. Contact your local Tektronix Field Office or representative for assistance in making specific measurements with this instrument.

Peak-to-Peak Voltage Measurements (AC)

To make peak-to-peak voltage measurements, use the following procedure:

1. Apply the signal to either input connector.

2. Set the DISPLAY MODE and TRIGGER SOURCE switches to display the channel used.

3. Set the coupling switch to AC.

NOTE

For low-frequency signals below about 30 hertz use the DC position to prevent attenuation of the signal.

4. Set the VOLTS/DIV switch to display about five divisions of the waveform vertically.

5. Set the time-base Triggering controls for a stable display. Set the time-base unit to a sweep rate which displays several cycles of the waveform.

6. Turn the 7A18 POSITION control so the lower portion of the waveform coincides with one of the graticule lines below the center horizontal line, and the top of the waveform is within the viewing area. With the time-base Position control, move the display so one of the upper peaks lies near the center vertical line (see Fig. 2-2).

7. Measure the divisions of vertical deflection peak-to-peak. Check that the VARIABLE (VOLTS/DIV) control is in the CAL IN position.

NOTE

This technique can also be used to make measurements between two points on the waveform, rather than peak to peak.

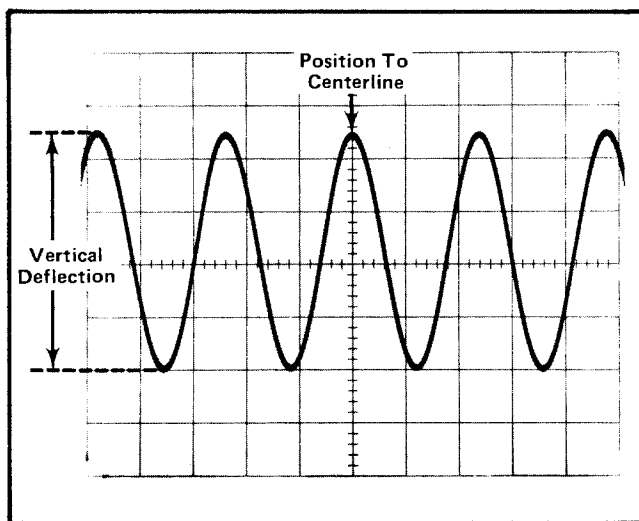

Fig. 2-2. Measuring the peak-to-peak voltage of a waveform.

8. Multiply the deflection measured in step 7 by the VOLTS/DIV switch setting. Include the attenuation factor of the probe if used.

EXAMPLE: Assume that the peak to peak vertical deflection is 4.5 divisions (see Fig. 2-2) using a 10X attenuator probe, and the VOLTS/DIV switch is set to 1 V.

$$\text{Volts Peak to Peak} = \text{vertical deflection (divisions)} \times \text{VOLTS/DIV setting} \times \text{probe attenuation factor}$$

Substituting the given values:

$$\text{Volts Peak-to-Peak} = 4.5 \times 1 \times 10$$

The peak-to-peak voltage is 45 volts.

Instantaneous Voltage Measurements (DC)

To measure the DC level at a given point on a waveform, proceed as follows:

1. Connect the signal to either input connector.
2. Set the DISPLAY MODE and TRIGGER SOURCE switches to display the channel used.
3. Set the VOLTS/DIV switch to display about five divisions of the waveform.
4. Set the coupling switch to GND and position the trace to the bottom graticule line or other reference line. If the voltage is negative with respect to ground, position the trace to the top graticule line. Do not move the POSITION control after this reference line has been established.

NOTE

To measure a voltage level with respect to a voltage other than ground, make the following changes to step 4. Set the coupling switch to DC and apply the reference voltage to the input connector. Then position the trace to the reference line.

5. Set the coupling switch to DC. The ground reference line can be checked at any time by switching to the GND position.

6. Set the time-base Triggering controls for a stable display. Set the time-base sweep rate for an optimum display of the waveform.

7. Measure the distance in divisions between the reference line and the point on the waveform at which the DC level is to be measured. For example, in Fig. 2-3 the measurement is between the reference line and point A.

8. Establish the polarity of the waveform. With the CH 2 POLARITY switch in the +UP position, any point above the reference line is positive.

9. Multiply the distance measured in step 7 by the VOLTS/DIV setting. Include the attenuation factor of the probe, if used.

EXAMPLE: Assume the vertical distance measured is 3.6 divisions (see Fig. 2-3) and the waveform is above the reference line using a 10X probe with a VOLTS/DIV setting of 0.5 V.

Using the formula:

$$\text{Instantaneous Voltage} = \text{vertical distance (divisions)} \times \text{polarity} \times \text{VOLTS/DIV setting} \times \text{probe attenuation factor}$$

Substituting the given values:

$$\text{Instantaneous Voltage} = 3.6 \times +1 \times 0.5 \text{ V} \times 10$$

The instantaneous voltage is 18 volts.

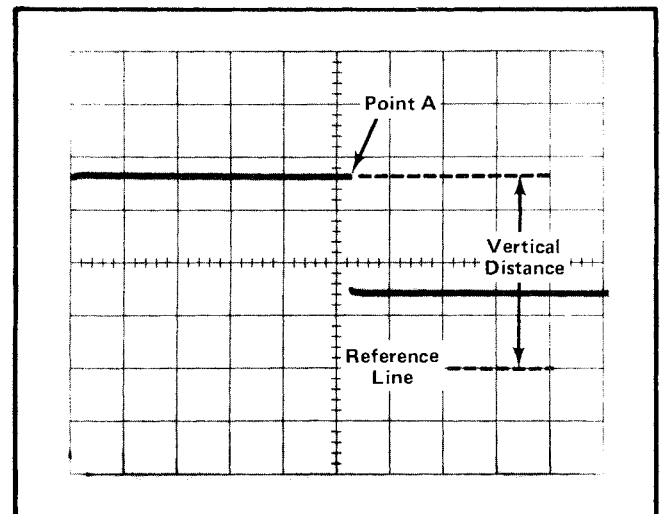

Fig. 2-3. Measuring instantaneous voltage with respect to some reference.

Comparison Measurements

In some applications it may be desirable to establish arbitrary units of measurement other than those indicated by the VOLTS/DIV switch. This is particularly useful when comparing unknown signals to a reference amplitude. One use for the comparison-measurement technique is to facilitate calibration of equipment where the desired amplitude does not produce an exact number of divisions of deflection. The adjustment will be easier and more accurate if arbitrary units of measurement are established so that the correct adjustment is indicated by an exact number of divisions of deflection. The following procedure describes how to establish arbitrary units of measure for comparison measurements.

To establish an arbitrary vertical deflection factor based upon a specific reference amplitude, proceed as follows:

1. Connect the reference signal to the input connector. Set the time-base unit sweep rate to display several cycles of the signal.

2. Set the VOLTS/DIV switch and the VARIABLE control to produce a display which is an exact number of vertical divisions in amplitude. Do not change the VARIABLE control after obtaining the desired deflection.

3. To establish an arbitrary vertical deflection factor so the amplitude of an unknown signal can be measured accurately at any setting of the VOLTS/DIV switch, the amplitude of the reference signal must be known. If it is not known, it can be measured before the VARIABLE VOLTS/DIV control is set in step 2.

4. Divide the amplitude of the reference signal (volts) by the product of the vertical deflection (divisions) established in step 2 and the setting of the VOLTS/DIV switch. This is the vertical conversion factor.

$$\text{Vertical Conversion Factor} = \frac{\text{reference signal amplitude (volts)}}{\text{vertical deflection (divisions)} \times \text{VOLTS/DIV switch setting}}$$

5. To measure the amplitude of an unknown signal, disconnect the reference signal and connect the unknown signal to the input connector. Set the VOLTS/DIV switch to a setting that provides sufficient vertical deflection to make an accurate measurement. Do not readjust the VARIABLE control.

6. Measure the vertical deflection in divisions and calculate the amplitude of the unknown signal using the following formula.

$$\text{Signal Amplitude} = \text{VOLTS/DIV setting} \times \text{vertical conversion factor} \times \text{vertical deflection (divisions)}$$

EXAMPLE: Assume a reference signal amplitude of 30 volts, a VOLTS/DIV setting of 5 V and the VARIABLE control adjusted to provide a vertical deflection of four divisions. Substituting these values in the vertical conversion factor formula (step 4):

$$\text{Vertical Conversion Factor} = \frac{30 \text{ V}}{4 \times 5 \text{ V}} = 1.5$$

Then with a VOLTS/DIV setting of 2 V, the peak-to-peak amplitude of an unknown signal which produces a vertical deflection of five divisions can be determined by using the signal amplitude formula (step 6):

$$\text{Signal Amplitude} = 2 \text{ V} \times 1.5 \times 5 = 15 \text{ volts}$$

Dual-Trace Phase Difference Measurements

Phase comparison between two signals of the same frequency can be made using the dual-trace feature of the 7A18. This method of phase difference measurement can be used up to the frequency limit of the oscilloscope system. To make the comparison, use the following procedure:

1. Set the CH 1 and CH 2 coupling switches to the same position, depending on the type of coupling desired.

2. Set the DISPLAY MODE to ALT or CHOP. In general, CHOP is more suitable for low frequencies and ALT is more suitable for high frequencies. Set the TRIGGER SOURCE to CH 1.

3. Connect the reference signal to the CH 1 input and the comparison signal to the CH 2 input. Use coaxial cables or probes which have similar time delay characteristics to connect the signals to the input connectors.

4. If the signals are of opposite polarity, set the CH 2 POLARITY switch to invert the channel 2 display. (Signals may be of opposite polarity due to 180° phase difference; if so, take this into account in the final calculation.)

5. Set the VOLTS/DIV switches and the VARIABLE controls of the two channels so the displays are equal and about five divisions in amplitude.

6. Set the time-base unit to a sweep rate which displays about one cycle of the waveforms. Set the Triggering controls for a stable display.

7. Center the waveforms on the graticule with the 7A18 POSITION controls.

8. Adjust the time-base Variable Time/Div control until one cycle of the reference signal occupies exactly eight horizontal divisions between the second and tenth vertical lines of the graticule (see Fig. 2-4). Each division of the graticule represents 45° of the cycle ($360^\circ \div 8 \text{ divisions} = 45^\circ/\text{division}$). The sweep rate can now be stated in terms of degrees as $45^\circ/\text{division}$.

9. Measure the horizontal difference between corresponding points on the waveform.

10. Multiply the measured distance (in divisions) by $45^\circ/\text{division}$ to obtain the exact amount of phase difference.

EXAMPLE: Assume a horizontal difference of 0.3 division with a sweep rate of $45^\circ/\text{division}$ as shown in Fig. 2-4.

Using the formula:

$$\text{Phase Difference} = \frac{\text{horizontal difference}}{\text{(divisions)}} \times \text{sweep rate (degrees/division)}$$

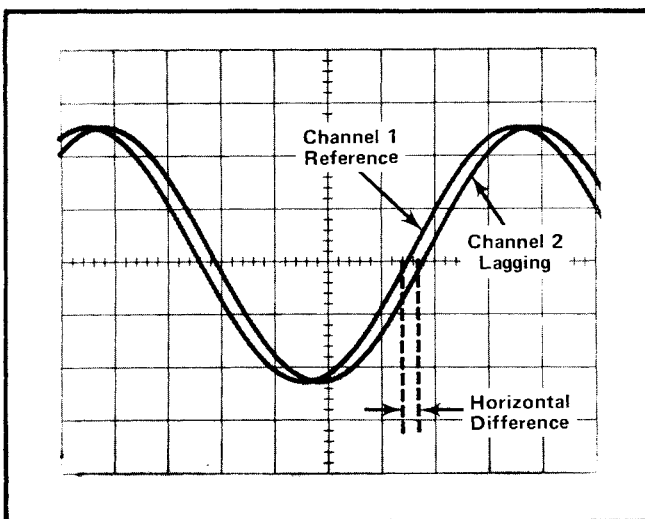

Fig. 2-4. Measuring phase difference between two signals.

Substituting the given values:

$$\text{Phase Difference} = 0.3 \times 45^\circ$$

The phase difference is 13.5° .

High Resolution Phase Measurements

More accurate dual-trace phase measurements can be made by increasing the sweep rate (without changing the Variable Time/Div control). One of the easiest ways to increase the sweep rate is with the time-base Magnifier switch. Set the Magnifier to X10 and determine the magnified sweep rate by dividing the sweep rate obtained previously by the amount of sweep magnification.

EXAMPLE: If the sweep rate is increased 10 times by the Magnifier, the magnified sweep rate is $45^\circ/\text{division} \div 10 = 4.5^\circ/\text{division}$. Fig. 2-5 shows the same signals as used in Fig. 2-4 but with the Magnifier set to X10. With a horizontal difference of 3 divisions, the phase difference is:

$$\text{Phase Difference} = \frac{\text{horizontal difference}}{\text{(divisions)}} \times \text{magnified sweep rate (degrees/division)}$$

Substituting the given values:

$$\text{Phase Difference} = 3 \times 4.5^\circ$$

The phase difference is 13.5° .

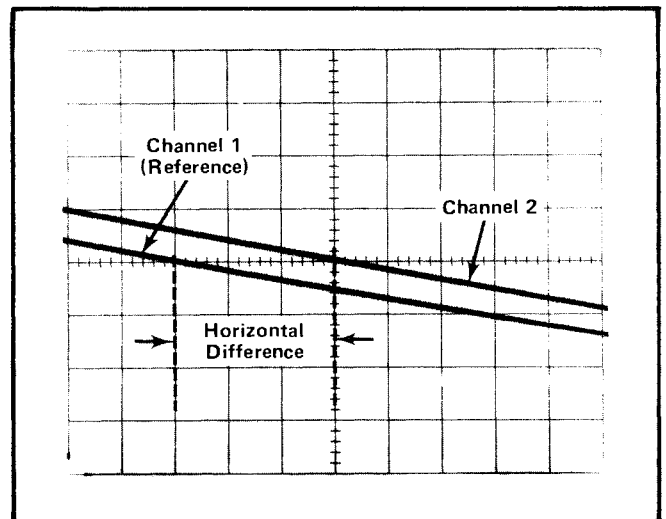

Fig. 2-5. High resolution phase measurement using time-base magnifier.

Common Mode Rejection

The ADD feature of the 7A18 can be used to display signals which contain undesirable components. These undesirable components can be eliminated through common-mode rejection. The procedure is as follows:

1. Set the DISPLAY MODE switch to ALT or CHOP and the TRIGGER SOURCE switch to MODE.

2. Connect the signal containing both the desired and undesired information to the CH 1 input connector.

3. Connect a signal similar to the unwanted portion of the CH 1 signal to the CH 2 input connector. For example, in Fig. 2-6 a line-frequency signal is connected to Channel 2 to cancel out the line-frequency component of the Channel 1 signal.

4. Set both coupling switches to the same setting, DC or AC, depending on the applied signal.

5. Set the VOLTS/DIV switches so the signals are about equal in amplitude.

6. Set the DISPLAY MODE switch to ADD. Set the CH 2 POLARITY switch to INVERT so the common-mode signals are of opposite polarity.

7. Adjust the Channel 2 VOLTS/DIV switch and VARIABLE control for maximum cancellation of the common-mode signal. The signal which remains should be only the desired portion of the Channel 1 signal.

EXAMPLE: An example of this mode of operation is shown in Fig. 2-6. The signal applied to Channel 1 contains unwanted line frequency components (Fig. 2-6A). A corresponding line frequency signal is connected to Channel 2 (Fig. 2-6B). Fig. 2-6C shows the desired portion of the signal as displayed when common-mode rejection is used.

The above procedure can also be used for examining a signal superimposed on some DC level when DC coupling is used. A DC voltage of the proper polarity applied to Channel 2 can be used to cancel out the DC portion of the signal applied to Channel 1.

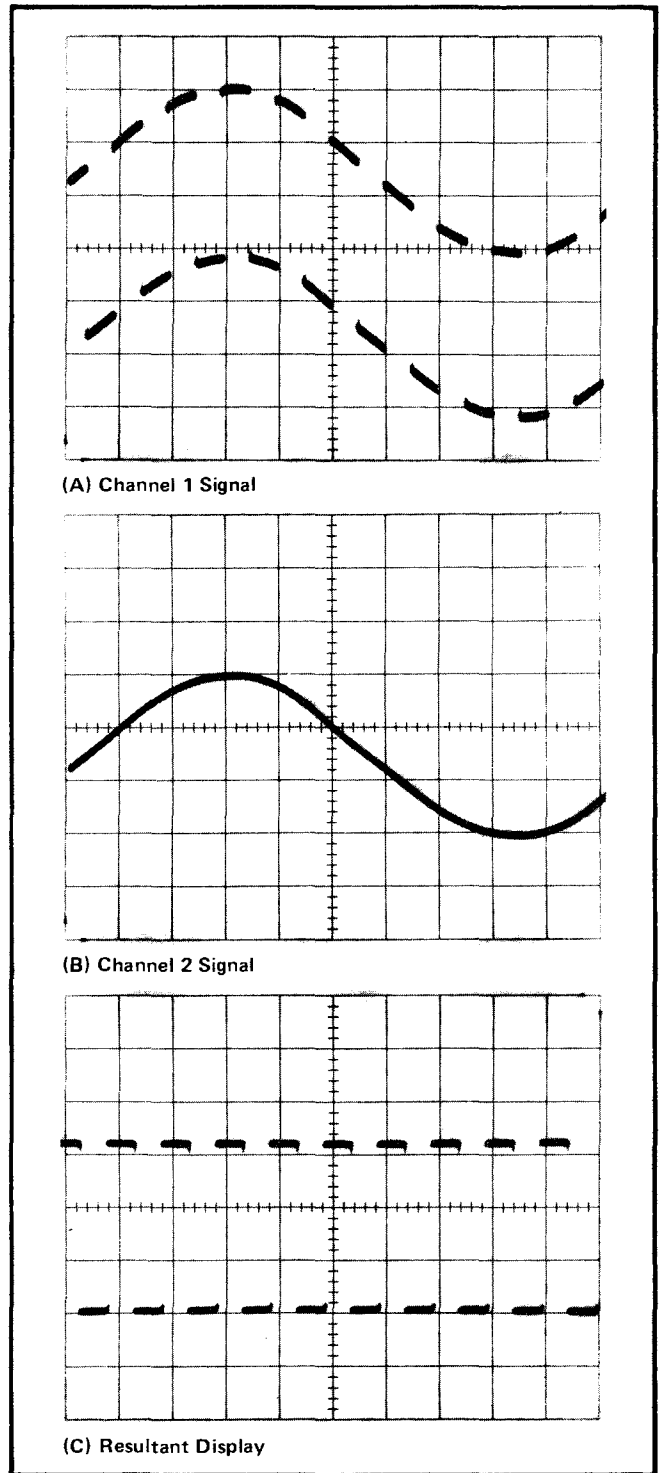

Fig. 2-6. Using the ADD mode for common-mode rejection. (A) Channel 1 signal contains desired information along with line-frequency component. (B) Channel 2 contains line frequency only. (C) Resultant CRT display using common-mode rejection.

SECTION 3

CIRCUIT DESCRIPTION

Change information, if any, affecting this section will be found at the rear of this manual.

Introduction

This section of the manual contains a description of the circuitry used in the 7A18 dual-trace amplifier. The description begins with a discussion of the instrument using the block diagram shown in the Diagrams section. Then, each circuit is described in detail using block diagrams to show the interconnections between stages in each major circuit and the relationship of the front-panel controls to the individual stages.

Complete schematics of each circuit are given in the Diagrams section. Refer to these schematics throughout the following circuit description for electrical values and relationship.

BLOCK DIAGRAM

The following discussion is provided to aid in understanding the overall concept of the 7A18 before the individual circuits are discussed in detail. Only the basic interconnections between the individual blocks are shown on the block diagram (see Diagrams section). Each block represents a major circuit within the instrument. The number on each block refers to the schematic on which the complete circuit is found.

The signal to be displayed on the CRT is applied to the input connector. The signal passes through the input coupling switch, where the appropriate coupling is selected, to the attenuators. The VOLTS/DIV switch selects the correct amount of attenuation and the signal is passed to the input amplifier.

The Channel 1 Input Amplifier circuit provides gain setting, variable gain control, and trace positioning. The Channel 2 Input Amplifier provides signal polarity inversion in addition to gain setting, variable gain control, and trace positioning. The outputs of these circuits are applied push-pull to the Signal and Trigger Channel Switches.

The Channel Switches select the proper signal and trigger as determined by the DISPLAY MODE and TRIGGER

SOURCE switches. The signal and trigger outputs are provided to the oscilloscope via the Interface Connector.

The Readout Encoding circuit (7A18 only) provides readout logic for the oscilloscope readout system. Data is supplied to the mainframe readout system identifying the polarity, deflection factor, the uncalibrated symbol (when the VARIABLE control is in the outward position), and the plug-in mode. When the IDENTIFY button is pressed, the trace is deflected about 0.3 division and the deflection factor readout is replaced by the word "IDENTIFY".

DETAILED CIRCUIT DESCRIPTION

ATTENUATOR

General

The Attenuator circuit determines the input coupling and the 7A18 deflection factor.

NOTE

The CH 1 and CH 2 Attenuator circuits are identical. To minimize duplication, only CH 1 is described in detail throughout this discussion.

AC-GND-DC Switch

Input signals connected to the input connector can be AC-coupled, DC-coupled, or internally disconnected. S100A is a cam-type switch; a contact-closure chart showing the operation is given on Diagram 1. The dots on this chart indicate when the associated contacts are in the position shown (open or closed). When the AC-GND-DC switch is in the DC position, the input signal is coupled directly to the Input Attenuator stage. In the AC position, the input signal passes through capacitor C10. This capacitor prevents the DC component of the signal from passing to the amplifier. The GND position opens the signal path and connects the input circuit of the amplifier to ground. This provides a ground reference without the need to disconnect the applied signal from the input connector. Resistor R102, connected across the AC-GND-DC switch, allows C10 to be precharged in the GND position so the trace remains on screen when switching to the AC position if the applied signal has a high DC level.

Input Attenuator

The effective overall deflection factor of the 7A18 is determined by the setting of the VOLTS/DIV switch, S100B. The basic deflection factor is five millivolts per division of CRT deflection. To increase the basic deflection factor to the values indicated on the front panel, precision attenuators are switched into the circuit. These attenuators are hybrid devices which contain the necessary resistances and capacitors. Each attenuator is replaceable as a unit. S100B is a cam-type switch and the dots on the contact-closure chart (see Diagram 1) indicate when the associated contacts are in the position shown (open or closed). In the 5 mV/Div position, input attenuation is not used; the input signal is connected directly to the input amplifier.

For switch positions above five millivolts, the attenuators are switched into the circuit singly or in pairs to produce the deflection factor indicated on the front panel. These attenuators are frequency-compensated voltage dividers. For DC and low-frequency signals, the attenuators are primarily resistance dividers and the voltage attenuation is determined by the resistance ratio in the circuit. The reactance of the capacitors in the circuit is so high at low frequencies that their effect is negligible. However, at higher frequencies, the reactance of the capacitors decreases and the attenuator becomes primarily a capacitance divider.

In addition to providing constant attenuation at all frequencies within the bandwidth of the instrument, the input attenuators are designed to maintain the same input RC characteristics (one megohm X 20 pF) for each setting of the VOLTS/DIV switch. Each attenuator contains an adjustable series capacitor to provide correct attenuation at high frequencies and an adjustable shunt capacitor to provide correct input capacitance.

CHANNEL 1 INPUT AMPLIFIER

General

The Channel 1 Input Amplifier converts the single-ended signal applied to the Channel 1 input connector to a differential (push-pull) output. Fig. 3-1 shows a detailed block diagram of the Channel 1 Input Amplifier. A schematic of this circuit is shown on Diagram 2 in the Diagrams section.

Input Source Follower

The Input Source Follower Q210A provides a high input impedance with a low impedance drive for the following stage. R210 limits the current drive to the gate of Q210A. Dual-diode CR210 provides circuit protection by limiting the voltage swing at the gate of Q210A to about \pm (positive or negative) 15 volts. Q210B provides a constant current

source for Q210A. Q210A and Q210B are encapsulated in the same case so that Q210B temperature-compensates the circuit.

Paraphase Cascode Amplifier

Paraphase amplifier Q220-Q320, in conjunction with Q225-Q325, forms a cascode amplifier. Q220-Q320 convert the single-ended input signal to a differential output signal. Diodes CR220-CR221 hold the voltage level at the base of Q220 close to ground to limit the voltage swing to about ± 0.6 volt. Common-base connected Q225-Q325 provide isolation between the paraphase amplifier and the GAIN-VARIABLE controls. The gain of the Channel 1 Input Amplifier is set in this stage by front-panel GAIN control R237A with the CAL IN switch pressed in. When the CAL IN switch is in the outward (uncalibrated) position and turned fully counterclockwise to minimum resistance, the gain of the amplifier is reduced by a factor of at least 2.5. Adjustment 1 R321 varies the base level of Q320 to provide the same voltage levels at the collectors of Q225 and Q325. This prevents a zero-volt reference trace from changing position when varying the GAIN or VARIABLE controls.

Second Cascode Amplifier

The Second Cascode Amplifier stage provides a signal gain of approximately two. This stage includes the POSITION control and, in the 7A18 only, trace IDENTIFY circuitry. The emitters of common-base connected Q250-Q350 provide a low-impedance point for injection of the POSITION control and IDENTIFY switch currents. Position of the trace is determined by the setting of the POSITION control, R11. This control changes the current drive to Q250-Q350. Since the emitters are a very low-impedance point in the circuit, there is negligible voltage change at these points. However, the change in current from the POSITION control produces a resultant DC voltage difference at the collectors to change the position of the trace. Trace identification is accomplished by inserting resistor R357 from ground through CR357 to the junction of R11-R256. This results in a slight increase in the emitter current of Q250 to cause the trace to move. This aids in identifying the channel 1 trace when multiple traces are displayed.

The network C246-C345-C245-R246-R345-R245 provides high frequency compensation. R245-C245 in this network provide high-frequency response adjustment for this stage.

Emitter Follower

Emitter Follower stage Q260-Q360 provides a low output impedance to drive the Signal and Trigger Channel Switches, U270-U470. This stage also provides isolation between the Second Cascode Amplifier and U270-U470.

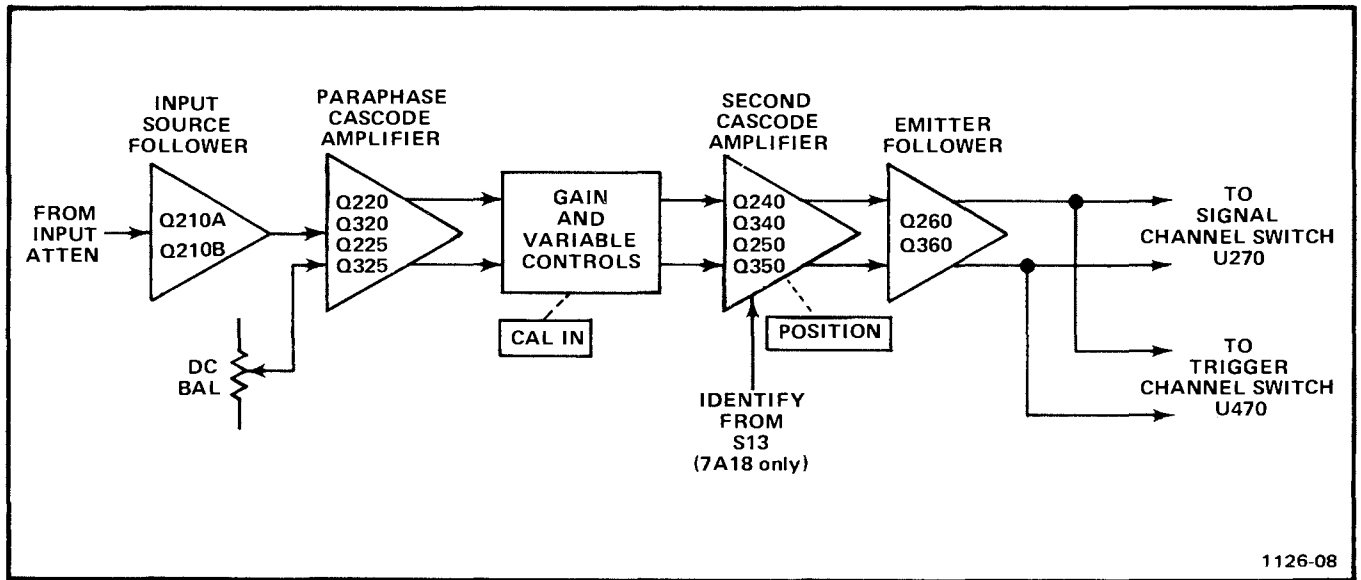

Fig. 3-1. Channel 1 Input Amplifier detailed block diagram.

CHANNEL 2 INPUT AMPLIFIER

General

The Channel 2 Input Amplifier circuit is basically the same as the Channel 1 Input Amplifier circuit. Only the differences between the two circuits are described here. Portions of this circuit not described in the following description operate in the same manner as for the Channel 1 Input Amplifier circuit (corresponding circuit numbers assigned in the 400 – 599 range). Fig. 3-2 shows a detailed block diagram of the Channel 2 Input Amplifier circuit. A schematic of this circuit is shown on Diagram 3 in the Diagrams section.

Paraphase Cascode Amplifier

The Paraphase Cascode Amplifier for Channel 2 consists of Q420, Q520, Q425, Q525, Q426, and Q526. In addition to the functions described under Channel 1 Input Amplifier, the Channel 2 Paraphase Cascode Amplifier stage provides a means of inverting the displayed signal. With the CH 2 POLARITY switch set to +UP, Q425 and Q525 are biased on and the signal is passed to the Second Cascode Amplifier stage as for the Channel 1 Input Amplifier. With the CH 2 POLARITY switch set to INVERT, Q425 and Q525 are biased off and Q426-Q526 are turned on to provide signal inversion.

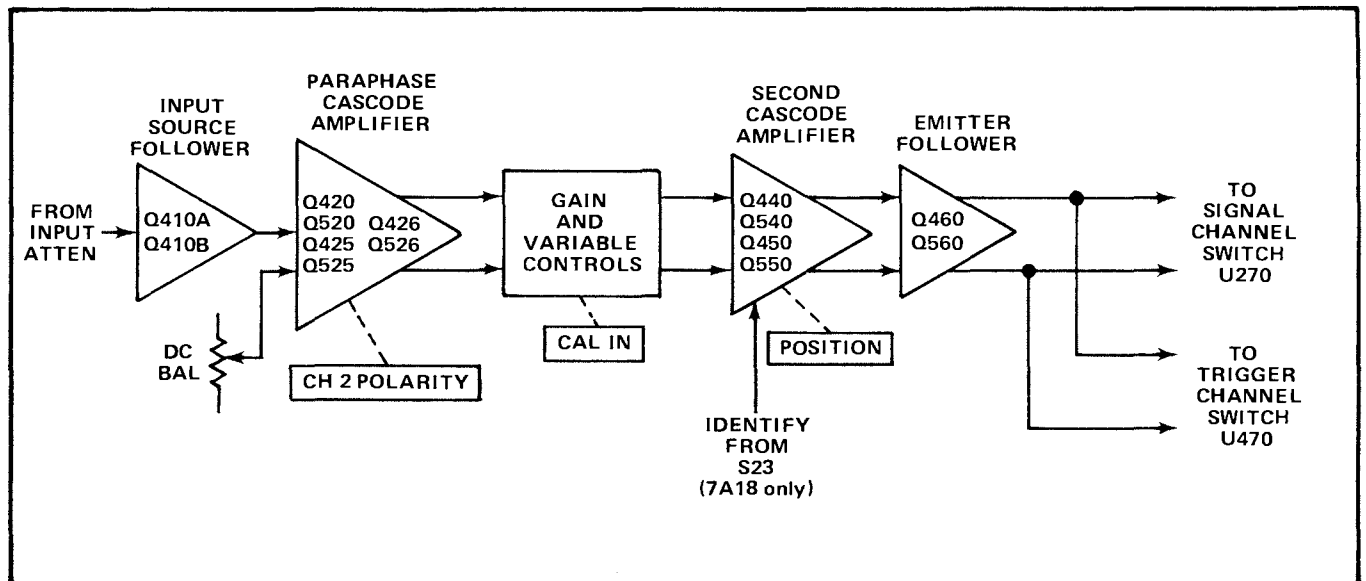

Fig. 3-2. Channel 2 Input Amplifier detailed block diagram.

Second Cascode Amplifier

The Second Cascode Amplifier for Channel 2 consists of Q440, Q540, Q450, and Q550. Position of the trace is set by the POSITION control, R21 or by network R455-R555 as determined by the DISPLAY MODE switch. In any DISPLAY MODE switch position other than ADD, +50 volts is applied to the center arm of the POSITION control through R32. The POSITION control varies the current drive to the emitters of Q450-Q550. Since the emitters are a very low-impedance point in the circuit, there is negligible voltage change at these points. However, the change in current from the POSITION control produces a resultant DC voltage difference at the collectors to change the position of the trace. When the DISPLAY MODE switch is in the ADD position, +50 volts is applied to the junction of resistors R455-R555 through R32 to balance the current drive to the emitters of Q450-Q550. This results in a fixed zero volts (approximately) difference between the collectors. Since +50 volts is not applied to the POSITION control in the ADD position of the DISPLAY MODE switch, the control setting has no effect on the circuit operation.

CHANNEL SWITCHES

General

The Channel Switches circuit provides Signal and Trigger outputs to the oscilloscope via the Interface Connector as determined by the DISPLAY MODE and TRIGGER SOURCE switches. A schematic of this circuit is given on Diagram 4 in the Diagrams section.

Signal Channel Switch

The Signal Channel Switch stage consists of integrated circuit U270 and its external components. This stage selects one, or mixes two input analog signals in response to inputs from the DISPLAY MODE switch. The Signal Channel Switch stage determines which input (CH 1 or CH 2) provides the signal to the oscilloscope as controlled by the DISPLAY MODE switch setting. Resistors R276-R277 and R376-R377 set the current gain for each channel. Networks C274-R274-C275-R275 and C374-R374-C375-R375 provide high-frequency compensation for each channel. C275 and C375 in these networks are high-frequency compensation adjustments.

Fig. 3-3 shows the U270 input combinations for each position of the DISPLAY MODE switch. When the level at pin 14 is LO the output of U270 is determined by the level at pin 4. With the level at pin 14 HI and the level at pin 4 LO, the signals from both channel 1 and channel 2 are passed to the Signal Output stage. This condition occurs only when the DISPLAY MODE switch is set to ADD. In this operating mode the signal output is the algebraic sum of channel 1 and channel 2 signals and the resultant signal determines the mainframe deflection.

DISPLAY MODE SELECTED	U270	
	Pin 4	Pin 14
CH 1	LO	LO
ALT	**	LO
ADD	LO	HI
CHOP	*	LO
CH 2	HI	LO

*Level is switched between the HI-level and LO-level at an approximate 0.5 megahertz rate.

**Level is switched between the HI-level and LO-level at a rate determined by the setting of the time-base unit sweep rate.

Fig. 3-3. U270 input combinations for DISPLAY MODE selection.

Trigger Channel Switching

The Trigger Channel Switch U470 is identical to the Signal Channel Switch. This stage determines which input (CH 1 or CH 2) provides the trigger signal for internal triggering of the time-base unit. The selection of the trigger signal is controlled by inputs from the TRIGGER SOURCE switch. Resistors R476-R477 and R576-R577 set the current gain for each channel. Networks C474-R474-C475-R475 and C574-R574-C575-R575 provide high-frequency compensation for each channel.

An input/output table for this stage is shown in Fig. 3-4. When the level at pin 14 is LO, the output of U470 is determined by the level at pin 4. With the level at pin 14 HI and the level at pin 4 LO, the channel 1 and channel 2 triggers are added algebraically.

Signal and Trigger Output

The Signal Output stage, Q280-Q380, and the Trigger Output stage, Q480-Q580, are similar. Each stage consists of a pair of common-base connected transistors which provide the DC level shifting necessary to drive the mainframe circuits.

DISPLAY MODE AND TRIGGER SWITCHING

General

The Display Mode and Trigger Switching circuit determines which input signal (Channel 1 or Channel 2) provides the Signal and Trigger outputs to the mainframe as selected by the DISPLAY MODE and TRIGGER SOURCE switches. This circuit also provides plug-in mode information to the mainframe chop blanking circuit, and readout control information for proper CRT display.

DISPLAY MODE Switch

The DISPLAY MODE switch provides logic level outputs to the Signal Channel Switch stage (U270, Channel Switches diagram 4). A table of the outputs for each position of the DISPLAY MODE switch is shown in Fig. 3-3.

TRIGGER SOURCE Switch

The TRIGGER SOURCE switch provides logic level outputs to the Trigger Channel Switch (U470, Channel Switches diagram 4). A table of the outputs for each switch position is shown in Fig. 3-4.

INPUT		OUTPUT		
Display Mode Switch	Trigger Source Switch	U470 Pins		Trigger Signal Source
		4	14	
CH 1	CH 1	LO	LO	CH 1
	MODE	LO	LO	CH 1
	CH 2	HI	LO	CH 2
ALT	CH 1	LO	LO	CH 1
	MODE	HI-LO	LO	Alternates between CH 1 and CH 2
	CH 2	HI	LO	CH 2
ADD	CH 1	LO	LO	CH 1
	MODE	LO	HI	CH 1 and CH 2 added
	CH 2	HI	LO	CH 2
CHOP	CH 1	LO	LO	CH 1
	MODE	LO	HI	CH 1 and CH 2 added
	CH 2	HI	LO	CH 2
CH 2	CH 1	LO	LO	CH 1
	MODE	HI	LO	CH 2
	CH 2	HI	LO	CH 2

Fig. 3-4. Input/Output combinations for DISPLAY MODE and TRIGGER SOURCE switch selections.

CONNECTORS AND READOUT

General

The Connectors and Readout circuit consists of the power supply and signal distribution from the Interface Connector and the Readout Encoding circuit. A schematic of this circuit is shown on Diagram 6 in the Diagrams section.

Connectors

All the connections made to the mainframe by the 7A18 are shown on the Connectors portion of Diagram 6. Also shown are the power supply decoupling components.

Readout Encoding (7A18 only)

The Readout Encoding circuit consists of switching resistors and probe sensing stage Q620. This circuit encodes the Channel 1 and 2, Row and Column output lines for readout of deflection factor, uncalibrated deflection factor (VARIABLE) information, and signal inversion (channel 2 only). Data is encoded on these output lines by switching resistors between them and the time-slot input lines, or by adding current through Q620.

R647-CR647 are switched between time-slot three (TS-3) and Column output line when the CAL IN switch is in the uncal position. This results in the symbol > (greater than) being displayed preceding the deflection factor readout. R648 (Channel 2 only) is switched between TS-2 and the Column output line when the CH 2 POLARITY switch is in the INVERT position. This results in the symbol ↓ (inverted) being displayed preceding the deflection factor readout.

Switching resistors are used to indicate the setting of the VOLTS/DIV switch to the mainframe readout system. The VOLTS/DIV switch is a cam-type switch. The dots on the contact-closure chart (see Diagram 6) indicate when the associated contacts are closed. R633, R634, and R635 select the number 1, 2, or 5 depending on the resistor combination that is switched in. R637 selects the m (milli-) prefix and R639 selects the symbol V (volts) in the 5 mV through .5 V (500 mV) positions of the VOLTS/DIV switch. R638 selects the symbol V in the 1, 2, and 5 V positions. R630, R631, and the output of the probe sensing stage (Q620) select the decimal point (number of zeroes) again depending on the resistor combination switched in by the VOLTS/DIV switch.

Probe sensing stage Q620 identifies the attenuation factor of the probe connected to the input connector by sensing the amount of current flowing from the current sink through the probe coding resistance. The output of this circuit corrects the mainframe readout system to include the probe attenuation factor. The third contact of the input connector provides the input to the probe sensing stage from the probe coding resistance (coded probes only; see Operating Instructions). The third contact is also used for the IDENTIFY input. The coding resistor forms a voltage divider with R621 through CR621 to the -15 V supply. The resultant voltage sets the bias on Q620 and determines, along with emitter resistor R622, the collector current. When the -15 volt time-slot pulse is applied to Interface Connector B33, Q620 is interrogated and its collector current is added to the column current output through Interface Connector A37.

Circuit Description—7A18/7A18N

With a 1X probe (or no probe) connected to the input connector, Q620 is turned off. The deflection factor readout is determined by the VOLTS/DIV switch position. With a 10X probe connected, the bias on Q620 will allow 100 microamperes of collector current to flow. This increases the deflection factor readout by a factor of 10.

The IDENTIFY button (S13 or S23 on Diagram 1) does two things when pressed:

1. It causes the trace representing the appropriate channel of the 7A18 to move about 0.3 division (see the discussion on the Channel 1 or Channel 2 Input Amplifier).

2. Forward biases CR621 and Q620 to result in a sufficient amount of collector current which, when added to the column current output, replaces the deflection factor readout with the word "IDENTIFY".

These two actions aid in identifying the 7A18 trace when multiple traces are displayed. When the IDENTIFY button is released, the deflection factor readout and trace position are restored.

For further information on the operation of the readout system, see the oscilloscope instruction manual.

SECTION 4

MAINTENANCE

Change information, if any, affecting this section will be found at the rear of this manual.

Introduction

This section of the manual contains maintenance information for use in preventive maintenance, corrective maintenance, and troubleshooting of the 7A18.

Further maintenance information relating to component color codes and soldering techniques can be found in the instruction manuals for the 7000-series oscilloscopes.

PREVENTIVE MAINTENANCE

General

Preventive maintenance, consisting of cleaning, visual inspection, lubrication, etc., performed on a regular basis, will improve the reliability of this instrument. Periodic checks on the semiconductor devices used in the unit are not recommended as a preventive maintenance measure. See semiconductor-checking information given under Troubleshooting.

Cleaning

CAUTION

Avoid the use of chemical cleaning agents which might damage the plastics in this instrument. Avoid chemicals containing benzene, toluene, xylene, acetone, or similar solvents.

Front Panel. Loose dust may be removed with a soft cloth or a dry brush. Water and mild detergent may be used; however, abrasive cleaners should not be used.

Interior. Cleaning the interior of the unit should precede calibration, since the cleaning process could alter the settings of the calibration adjustments. Use low-velocity compressed air to blow off the accumulated dust. Hardened dirt can be removed with a soft, dry brush, cotton-tipped swab, or cloth dampened with a mild detergent and water solution.

Lubrication

Use a cleaning-type lubricant on shaft bushings, interconnecting plug contacts, and switch contacts. Lubricate switch detents with a heavier grease. A lubrication kit containing the necessary lubricating materials and instructions is available through any Tektronix Field Office. Order Tektronix Part Number 003-0342-01.

Recalibration

To ensure accurate measurements, the 7A18 should be checked after each 1000 hours of operation or every six months if used infrequently. A complete performance check procedure is given in Part I for Section 5.

The performance check procedure can be helpful in isolating major troubles in the unit. Moreover, minor troubles not apparent during regular operation may be revealed and corrected.

TROUBLESHOOTING

General

The following is provided to augment information contained in other sections of this manual when troubleshooting the 7A18. The schematic diagrams, Circuit Description, and Calibration sections should be used to full advantage. The Circuit Description section gives detailed information on circuit behavior and output requirements.

Troubleshooting Aids

Diagrams. Circuit diagrams are given on foldout pages in Section 7. The circuit number and electrical value of each component in this instrument are shown on the diagrams. Important voltages are also shown.

Circuit Board. The circuit board used in the 7A18 is outlined on the schematic diagrams, and a photograph of the board is shown on the back of Diagram 1. Each board-mounted electrical component is identified on the photograph by its circuit number.

Component and Wiring Color Code. Colored stripes or dots on resistors and capacitors signify electrical values, tolerances, etc., according to the EIA standard color code. Components not color coded usually have the value printed on the body.

The insulated wires used for interconnection in the 7A18 are color coded to facilitate tracing a wire from one point to another in the unit.

Semiconductor Lead Configuration. Fig. 4-1 shows the lead configuration of the semiconductor devices used in this instrument.

Troubleshooting Equipment

The following equipment is useful for troubleshooting the 7A18.

1. Semiconductor Tester—Some means of testing the transistors, diodes, and FET's used in this instrument is helpful. A transistor-curve tracer such as the Tektronix Type 576 will give the most complete information.

2. DC Voltmeter and Ohmmeter—A voltmeter for checking voltages within the circuit and an ohmmeter for checking resistors and diodes are required.

3. Test Oscilloscope—A test oscilloscope is required to view waveforms at different points in the circuit.

A Tektronix 7000-series Oscilloscope equipped with a readout system, 7D13 Digital Multimeter unit, 7B-series Time-Base unit, and a 7A-series Amplifier unit with a 10X probe will meet the needs for items 2 and 3.

Troubleshooting Procedure

This troubleshooting procedure is arranged in an order which checks the simple trouble possibilities before proceeding with extensive troubleshooting.

1. Check Control Setting. An incorrect setting of the 7A18 controls can indicate a trouble that does not exist. If there is any question about the correct function or operation of a control or front-panel connector, see the Operating Instructions section.

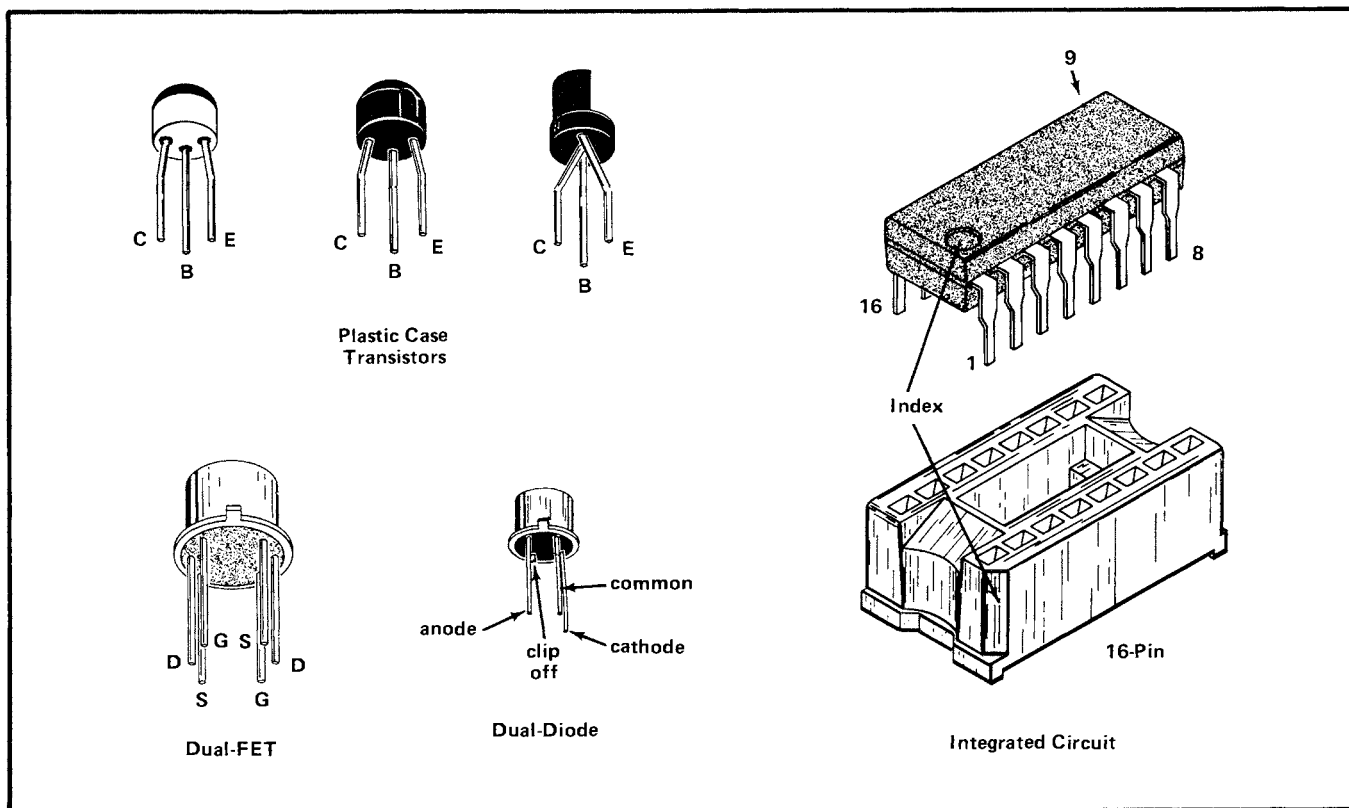

Fig. 4-1. Electrode configuration for semiconductors used in this instrument.

2. Check Associated Equipment. Before proceeding with troubleshooting of the 7A18, check that the equipment used with this instrument is operating correctly. If possible, substitute an amplifier unit known to be operating correctly into the indicator unit and see if the problem persists. Check that the inputs are properly connected and that the interconnecting cables are not defective.

3. Visual Check. Visually check the portion of the instrument in which the trouble is suspected. Many troubles can be located by visual indications, such as unsoldered connections, broken wires, damaged circuit boards, damaged components, etc.

4. Check Instrument Performance. Check the calibration of the unit, or the affected circuit by performing Part I — Performance Check of Section 5. The apparent trouble may only be a result of misadjustment and may be corrected by calibration. Complete calibration instructions are given in Part II of Section 5.

5. Check Voltages and Waveforms. Often the defective component or stage can be located by checking for the correct voltage or waveform in the circuit. Typical voltages and waveforms are given on the diagrams; however, these are not absolute and may vary slightly between instruments. To obtain operating conditions similar to those used to take these readings, see the instructions in the Diagrams section.

6. Check Individual Components. The following methods are provided for checking the individual components in the 7A18. Components which are soldered in place are best checked by disconnecting one end to isolate the measurement from the effects of surrounding circuitry.

A. TRANSISTORS AND INTEGRATED CIRCUITS. The best check of transistor and integrated circuit operation is actual performance under operating conditions. If a transistor or integrated circuit is suspected of being defective, it can best be checked by substituting a component known to be good; however, be sure that circuit conditions are not such that a replacement might also be damaged. If substitute transistors are not available, use a dynamic tester (such as Tektronix Type 576). Static-type testers may be used, but since they do not check operation under simulated operating conditions some defects may go unnoticed. Fig. 4-1 shows base pin and socket arrangements of semiconductor devices. Be sure the power is off before attempting to remove or replace any transistor or integrated circuit.

Integrated circuits can be checked with a voltmeter, test oscilloscope, or by direct substitution. A good understanding of the circuit description is essential to troubleshooting circuits using integrated circuits. Use care when checking voltages and waveforms around the integrated circuits so that adjacent leads are not shorted together. An integrated-circuit test clip provides a convenient means of clipping a test probe to the 14- and 16-pin integrated circuits. This device also doubles as an integrated-circuit extraction tool.

B. DIODES. A diode can be checked for an open or for a short circuit by measuring the resistance between terminals with an ohmmeter set to the R X 1k scale. The diode resistance should be very high in one direction and very low when the meter leads are reversed. Do not check tunnel diodes or back diodes with an ohmmeter.



Do not use an ohmmeter scale that has a high internal current. High currents may damage the diodes.

C. RESISTORS. Check resistors with an ohmmeter. Resistor tolerance is given in the Electrical Parts List. Resistors normally do not need to be replaced unless the measured value varies widely from the specified value.

D. CAPACITORS. A leaky or shorted capacitor can be detected by checking resistance with an ohmmeter on the highest scale. Use an ohmmeter which will not exceed the voltage rating of the capacitor. The resistance reading should be high after initial charge of the capacitor. An open capacitor can best be detected with a capacitance meter, or by checking whether the capacitor passes AC signals.

7. Repair and Readjust the Circuit. Special techniques required to replace components in this unit are given under Component Replacement. Be sure to check the performance of any circuit that has been repaired or that has had any electrical components replaced. Recalibration of the affected circuit may be necessary.

REPLACEMENT PARTS

Standard Parts

All electrical and mechanical part replacements for the 7A18 can be obtained through your local Tektronix Field Office or representative. However, many of the standard electronic components can be obtained locally in less time than is required to order them from Tektronix, Inc. Before purchasing or ordering replacement parts, check the parts lists for value, tolerance, rating, and description.

NOTE

When selecting replacement parts, it is important to remember that the physical size and shape of the component may affect its performance in the instrument. All replacement parts should be direct replacements unless it is known that a different component will not adversely affect the instrument performance.

Special Parts

Some parts are manufactured or selected by Tektronix to satisfy particular requirements, or are manufactured for Tektronix to our specifications. These special parts are indicated in the parts list by an asterisk preceding the part number. Most of the mechanical parts used in this instrument have been manufactured by Tektronix. Order all special parts directly from your local Tektronix Field Office or representative.

Ordering Parts

When ordering replacement parts from Tektronix, Inc., refer to the Parts Ordering Information and Special Notes and Symbols on the page immediately preceding the Electrical Parts List section. Include the following information:

1. Instrument type (7A18)
2. Instrument Serial Number
3. A description of the part (if electrical, include the circuit number)
4. Tektronix Part Number

Soldering Techniques

Attenuator Circuit Boards. The Attenuator circuit boards are made from polyphenylene oxide because of its excellent electrical characteristics. Use more than normal care when cleaning or soldering this material. The following rules should be observed when removing or replacing parts:

1. Use a very small soldering iron (not over 15 watts).
2. Do not apply more heat, or apply heat for a longer time, than is absolutely necessary.
3. Use a vacuum-type desoldering tool to remove the excess solder from the circuit board.
4. Do not apply any solvent containing ketones, esters, or halogenated hydrocarbons.
5. To clean, use only water-soluble detergents, ethyl, methyl, or isopropyl alcohol.

COMPONENT REPLACEMENT**General**

The exploded-view drawing associated with the Mechanical Parts List may be helpful when disassembling or re-assembling individual components or sub-assemblies.

Circuit Board Removal

In general, the circuit boards used in the 7A18 need never be removed unless they must be replaced. Electrical connections to the boards are made by soldered connections. If it is necessary to replace a circuit board assembly, use the following procedures.

A. READOUT CIRCUIT BOARD REMOVAL (7A18 only)

1. Disconnect the wires connected to the outside of the board.
2. Remove the seven screws holding the board to the mounting surface.
3. Disconnect the wires connected to the inside of the board.
4. Remove the board from the unit.
5. To replace the board, reverse the order of removal.

B. ATTENUATOR CIRCUIT BOARD REMOVAL

1. Remove the readout board as outlined in the previous procedure.
2. Disconnect the resistor/capacitor connected to the rear of the board.
3. Loosen the front set screw on the VARIABLE/GAIN control shaft coupling (use a 0.050-inch hex-key wrench).
4. Remove the red VARIABLE control knob and rod from the control shaft.
5. Remove the remaining front-panel knobs using a 1/16-inch hex-key wrench.
6. Remove the front panel from the instrument.
7. Remove the attenuator shields.
8. Disconnect the wires and resistor from the input BNC connector.
9. Remove the input BNC connector.

10. Remove the POSITION control using a 5/16-inch nut driver.

11. Remove the attenuator board with cam switch from the instrument.

12. To replace the board, reverse the order of removal.

C. AMPLIFIER CIRCUIT BOARD REMOVAL

1. Remove the Readout circuit boards as given previously.

2. Remove the plastic plug-in guide from the rear of the instrument.

3. Disconnect the wires connected to the board from the front-panel controls.

4. Loosen the front hex-socket screw in the front coupling of the VARIABLE control shaft using a 0.050-inch hex-key wrench. Pull the VARIABLE knob and shaft from the front of the instrument.

5. Loosen the front hex-socket screw in the coupling between the DISPLAY MODE and TRIGGER SOURCE switch sections. Pull the TRIGGER SOURCE knob and long shaft from the front of the instrument.

6. Loosen the front hex-socket screw in the coupling of the DISPLAY MODE switch shaft using a 5/16-inch hex-key wrench. Pull the DISPLAY MODE knob and long shaft from the front of the instrument.

7. Disconnect the resistor-capacitor combinations connected to the ceramic strips at the front of the board.

8. Remove the screws and nuts securing the board to the chassis or other mounting surface.

9. Remove the board from the instrument.

10. To replace, reverse the order of removal.

Switch Replacement

Several types of switches are used in the 7A18. The following special maintenance information is provided for the cam-type switches and rotary switches.

A. CAM-TYPE SWITCHES

CAUTION

Repair of cam-type switches should be undertaken only by experienced maintenance personnel. Switch alignment and spring tension of the contacts must be carefully maintained for proper operation of the switch. For assistance in maintenance of the cam-type switches, contact your local Tektronix Field Office or representative.

B. ROTARY SWITCHES

Single wafers on the DISPLAY MODE and TRIGGER SOURCE switches are not normally replaced. If any part of these switches is defective, the entire switch assembly should be replaced. A new switch can be ordered through your Tektronix Field Office.

CAUTION

When disconnecting or connecting leads to a wafer-type rotary switch, do not let solder flow around and beyond the rivet on the switch terminal. Excessive solder can destroy the spring tension of the contact.

Transistor and Integrated Circuit Replacement

Transistors and IC's should not be replaced unless they are actually defective. If removed from their sockets during routine maintenance, return them to their original sockets. Special care must be given to integrated circuit leads, because they can easily be damaged in removal from sockets. Unnecessary replacement or switching of components may affect the calibration of the instrument. When a transistor is replaced, check the operation of that part of the instrument that may be affected.

Recalibration After Repair

After any electrical component has been replaced, the calibration of that particular circuit should be checked, as well as the calibration of other closely related circuits. The Performance Check instructions given in Part I of Section 5 provide a quick and convenient means of checking the instrument operation. The Calibration Procedure in Part II of Section 5 can then be used to adjust the operation to meet the Performance Requirements listed in Section 1.

Repackaging for Shipment

If the Tektronix instrument is to be shipped to a Tektronix Service Center for service or repair, attach a tag showing: owner (with address) and the name of an individual at your firm that can be contacted, complete instrument serial number and a description of the service required.

Save and re-use the package in which your instrument was shipped. If the original packaging is unfit for use or not available, repackage the instrument as follows:

Surround the instrument with polyethylene sheeting to protect the finish of the instrument. Obtain a carton of corrugated cardboard of the correct carton strength and having inside dimensions of no less than six inches more than the instrument dimensions. Cushion the instrument by tightly packing three inches of dunnage or urethane foam between carton and instrument, on all sides. Seal carton with shipping tape or industrial stapler

The carton test strength for your instrument is 200 pounds.

SECTION 5

CALIBRATION

Change information, if any, affecting this section will be found at the rear of the manual.

Recalibration Interval

To assure instrument accuracy, check the calibration of the 7A18 every 1000 hours of operation, or every six months if used infrequently. Before complete calibration, thoroughly clean and inspect this instrument as outlined in the Maintenance section.

Tektronix Field Service

Tektronix, Inc. provides complete instrument repair and recalibration at local Field Service Centers and the Factory Service Center. Contact your local Tektronix Field Office or representative for further information.

Using This Procedure

General. This section provides several features to facilitate checking or adjusting the 7A18. These are:

Index. To aid in locating a step in the Performance Check or Adjustment procedure, an index is given preceding Part I — Performance Check and Part II — Adjustment procedure.

Performance Check. The performance of this instrument can be checked without removing the side shields or making internal adjustments by performing only Part I — Performance Check. This procedure checks the instrument against the tolerances listed in the Performance Requirement column of Section 1. In addition, a cross-reference is provided to the step in Part II — Adjustment which will return the instrument to correct calibration. In most cases, the adjustment step can be performed without changing control settings or equipment connections.

Adjustment Procedure. To return this instrument to correct calibration with the minimum number of steps, perform only Part II — Adjustment. The Adjustment procedure gives the recommended calibration procedure for all circuits in this instrument.

Complete Performance Check/Adjustment. To completely check and adjust all parts of this instrument, perform both Parts I and II. Start the complete procedure by performing the Adjustment procedure and follow this with the Performance Check. This method will assure that the

instrument is both correctly adjusted and performing within all Performance Requirements as given in Section 1.

TEST EQUIPMENT REQUIRED

General

The following test equipment and accessories, or its equivalent, is required for complete calibration of the 7A18. Specifications given for the test equipment are the minimum necessary for accurate calibration. Therefore, some of the specifications listed here may be somewhat less precise than the actual performance capabilities of the test equipment. All test equipment is assumed to be correctly calibrated and operating within the listed specifications.

The Performance Check and Adjustment procedures are based on this recommended equipment. If other equipment is substituted, control settings or calibration setup may need to be altered to meet the requirements of the equipment used. Detailed operating instructions for the test equipment are not given in this procedure. Refer to the instruction manual for the test equipment if more information is needed.

Calibration Equipment Alternatives

All of the test equipment is required to completely check and adjust this instrument. However, some of the items used only for the Performance Check can be deleted without compromising the instrument's measurement capabilities. For example, the low-frequency constant-amplitude signal generator is used only in the Performance Check and may be deleted if the user does not desire to check the lower frequency response or trigger source operation. Equipment used only for the Performance Check procedure is indicated by note 1; items required only for the Adjustment procedure are indicated by note 2.

Test Equipment

1. 7000-series oscilloscope, referred to as the Indicator Oscilloscope in this procedure. Tektronix 7403 recommended.

2. Time-Base plug-in unit, Tektronix 7B50.

Calibration—7A18/7A18N

3. Amplitude Calibrator. Output signal, one kilohertz square wave; output amplitude, 20 millivolts to 20 volts; amplitude accuracy, within 0.25%. Tektronix PG 506 Pulse Generator recommended.³

4. Medium-frequency constant-amplitude sine-wave generator.¹ Frequency, variable from 50 to 75 megahertz; reference frequency, 50 kilohertz; output amplitude, variable from 50 millivolts to 200 millivolts into 50 ohms; amplitude accuracy, output amplitude constant within 3% at 50 kilohertz and from 50 to 75 megahertz. For example, Tektronix SG 503 Signal Generator.³

5. Low-frequency constant-amplitude signal generator.¹ Frequency range, two hertz to 10 kilohertz; output amplitude, variable from 10 millivolts to 400 millivolts peak to peak. For example, General Radio 1310-B Oscillator (use General Radio Type 274 QBJ Adapter to provide BNC output).

6. Square-wave generator.² Must have the following output capabilities (may be obtained from separate generators): 12 volts amplitude into 50 ohms at one kilohertz with a risetime of 12 nanoseconds or less; 500 millivolts into 50 ohms at 100 kilohertz with a risetime of one nanosecond or less. Tektronix PG 506 Pulse Generator recommended (meets both output requirements).³

7. Plug-in extender.² Tektronix Part Number 067-0589-00.

Accessories

8. 18-inch cable.¹ Impedance, 50 ohms; type, RG-58/U; connectors, BNC. Tektronix Part No. 012-0076-00.

9. 42-inch cable. Impedance, 50 ohms; type RG-58/U; connectors, BNC. Tektronix Part No. 012-0057-01.

10. Five-nanosecond cable. Impedance, 50 ohms; type, RG-213/U; connectors, GR874. Tektronix Part No. 017-0502-00.

11. In-line GR termination. Impedance, 50 ohms; wattage rating, two watts; accuracy, $\pm 2\%$; connectors, GR874 input with BNC male output. Tektronix Part No. 017-0064-00.

12. Dual-input coupler.¹ Matched signal transfer to each input. Tektronix calibration fixture 067-0525-00.

13. 10X GR attenuator.² Impedance, 50 ohms; accuracy, $\pm 2\%$; connectors, GR874. Tektronix Part No. 017-0078-00.

14. In-line BNC termination.¹ Impedance, 50 ohms; wattage rating, two watts; accuracy, $\pm 2\%$; connectors, BNC. Tektronix Part No. 011-0049-01.

15. 10X BNC attenuator.¹ Impedance, 50 ohms; accuracy, $\pm 2\%$; connectors, BNC. Tektronix Part No. 011-0059-02.

16. Input RC normalizer.² Time constant, one megohm X 20 picofarads; attenuation, 2X; connectors, BNC. Tektronix calibration fixture 067-0538-00.

17. Adapter.² Adapts GR874 connector to BNC male connector. Tektronix Part No. 017-0064-00.

Adjustment Tools

18. Screwdriver. Three-inch shaft, 3/32-inch bit. For example, Xcelite R-3323.

19. Low-capacitance screwdriver.² 1 1/2-inch shaft. Tektronix Part No. 003-0000-00.

20. Tuning tool.² Handle with inserts for input capacitance and attenuator adjustments. Tektronix Part No. 003-0307-00, 003-0334-00, and 003-0497-00.

Preliminary Control Settings

Set the Indicator Oscilloscope and 7A18 controls as follows (for both Performance Check and Adjustment procedure):

Indicator Oscilloscope

Intensity	Midrange
Focus	Adjust for well-defined display
Graticule Illum	As desired
Calibrator	40 mV
Rate	1 kHz
Vert Mode	Left
Trig Source	Left Vert

7A18

DISPLAY MODE	CH 1
TRIGGER SOURCE	MODE
CH 2 POLARITY	+UP

CH 1 and CH 2

POSITION	Midrange
VOLTS/DIV	10 mV
AC-GND-DC	DC

¹ Required only for Performance Check.

² Required only for Adjustment procedure.

³ Requires TM 500-Series Power Module.

PART I-PERFORMANCE CHECK

Introduction

The following procedure checks the performance of the 7A18 without removing the covers or making internal adjustments. All tolerances given in this procedure are based on Section 1 of this manual.

Index to Part I — Performance Check

1. Check Channel 1 and 2 GAIN	Page 5-3
2. Check Channel 1 and 2 Deflection Factor Accuracy	Page 5-3
3. Check Channel 1 and 2 VARIABLE (VOLTS/DIV) Range	Page 5-4
4. Check Channel 1 and 2 Trace IDENTIFY (7A18 only)	Page 5-4
5. Check Channel 1 and 2 Upper Bandwidth	Page 5-4
6. Check Channel 1 and 2 Lower Frequency Response	Page 5-4
7. Check Channel Isolation	Page 5-5
8. Check Common-Mode Rejection Ratio	Page 5-5
9. Check Alternate Operation	Page 5-5
10. Check Chopped Operation	Page 5-6
11. Check Trigger Source Operation	Page 5-6

Preliminary Procedure for Performance Check

NOTE

The performance of this instrument can be checked at any temperature within the 0°C to +50°C range unless stated otherwise.

1. Install the 7A18 in the left vertical plug-in compartment of the Indicator Oscilloscope.

2. Connect the Indicator Oscilloscope to a power source which meets the frequency and voltage requirements of the oscilloscope power supply.

3. Turn the Indicator Oscilloscope power on. Allow at least twenty minutes warmup for checking the 7A18 to the given accuracy.

4. Set the controls as given under Preliminary Control Settings.

NOTE

The checks titled Channel 1 and 2 apply equally to both channels. Perform the check on the channel selected by the DISPLAY MODE switch.

1. Check Channel 1 and 2 GAIN

a. Connect the standard amplitude calibrator output to the CH 1 and CH 2 input connectors with the 42-inch BNC cable and dual-input coupler.

b. Set the standard amplitude calibrator for a 50-millivolt square-wave output.

c. CHECK—CRT display for a five-division display.

d. If necessary, adjust the front-panel GAIN control for exactly five divisions of vertical deflection. To adjust, press in the GAIN knob with a screwdriver and turn until the GAIN control is engaged.

e. Set the DISPLAY MODE switch to CH 2 and repeat parts c and d of this step for Channel 2.

2. Check Channel 1 and 2 Deflection Factor Accuracy

a. Set the Channel 1 AC-GND-DC switch to GND.

b. CHECK—Using the VOLTS/DIV and standard amplitude calibrator settings given in Table 5-1, check vertical deflection within 2% in each position of the VOLTS/DIV switch.

Performance Check—7A18/7A18N

c. Change the following control settings:

DISPLAY MODE	CH 1
CH 1 AC-GND-DC	DC
CH 2 AC-GND-DC	GND

d. Repeat part b of this step for Channel 1.

TABLE 5-1

Vertical Deflection Accuracy

VOLTS/DIV Switch Setting	Standard Amplitude Calibrator Output	Vertical Deflection in Divisions	Maximum Error for $\pm 2\%$ Accuracy (divisions)
5 mV	20 mV	4	± 0.08
10 mV	50 mV	5	Set in step 1
20 mV	0.1 V	5	± 0.1
50 mV	0.2 V	4	± 0.08
.1 V	0.5 V	5	± 0.1
.2 V	1 V	5	± 0.1
.5 V	2 V	4	± 0.08
1 V	5 V	5	± 0.1
2 V	10 V	5	± 0.1
5 V	20 V	4	± 0.08

3. Check Channel 1 and 2 VARIABLE (VOLTS/DIV) Range

a. Set the Channel 1 and 2 VOLTS/DIV switches to 10 mV and the standard amplitude calibrator for a 50-millivolt output.

b. Press and release the VARIABLE control to its outward position.

c. CHECK—With the VARIABLE control fully counter-clockwise, check for two divisions or less of deflection.

d. Return the VARIABLE control to the CAL IN position.

e. Change the following control settings:

DISPLAY MODE	CH 2
CH 1 AC-GND-DC	GND
CH 2 AC-GND-DC	DC

f. Repeat parts b, c, and d of this step for Channel 2.

4. Check Channel 1 and 2 Trace IDENTIFY (7A18 only)

a. Center the CRT display vertically with the 7A18 POSITION control.

b. CHECK—Press the IDENTIFY button and check that the trace moves upward.

c. Set the DISPLAY MODE switch to CH 1 and repeat parts a and b of this step for Channel 1.

d. Disconnect all test equipment.

5. Check Channel 1 and 2 Upper Bandwidth

a. Connect the medium-frequency constant-amplitude sine-wave generator to the 7A18 CH 1 input connector with the five-nanosecond GR cable and in-line 50-ohm GR termination.

b. Set the medium-frequency generator for an eight-division display (80 millivolts) at the 50-kilohertz reference frequency.

c. Increase the generator frequency until the display amplitude decreases to 5.6 divisions.

d. CHECK—Generator output frequency; must be at least 50 megahertz in a 7400-series mainframe, 60 megahertz in a 7500-series, or 75 megahertz in a 7700-series.

e. Disconnect the generator output from the CH 1 input connector and connect it to the CH 2 input connector.

f. Set the DISPLAY MODE switch to CH 2.

g. Repeat parts b, c, and d of this step for Channel 2.

h. CALIBRATION—See step 5 of the Adjustment procedure.

i. Disconnect all test equipment.

6. Check Channel 1 and 2 Lower Frequency Response

a. Change the following control settings:

CH 1 and CH 2	
VOLTS/DIV	5 mV
AC-GND-DC	AC

b. Set the time-base unit for a free-running sweep at a rate of two milliseconds/division.

c. Connect the low-frequency constant-amplitude sine-wave generator to the CH 2 input connector with the 42-inch BNC cable, 10X BNC attenuator, and 50-ohm BNC termination.

d. Set the low-frequency generator for a six-division display (30 millivolts) at 10 kilohertz.

e. Decrease the generator frequency until the display amplitude decreases to 4.2 divisions.

f. CHECK—Generator frequency; must be 10 hertz or less.

g. Disconnect the low-frequency generator from the CH 2 input connector and connect it to the CH 1 input connector.

h. Set the DISPLAY MODE switch to CH 1.

i. Repeat parts d through f of this step for Channel 1.

j. Disconnect all test equipment.

7. Check Channel Isolation

a. Change the following control settings:

CH 1 and CH 2	DC
AC-GND-DC	
CH 1 VOLTS/DIV	.1 V
CH 2 VOLTS/DIV	10 mV

b. Connect the medium-frequency generator to the CH 1 input connector with the five-nanosecond GR cable and in-line 50-ohm GR termination.

c. Set the generator for a two-division display (200 millivolts) at 50 megahertz.

d. Change the following control settings:

DISPLAY MODE	CH 2
CH 1 VOLTS/DIV	10 mV

e. Check—CRT display for 0.4 division or less deflection (channel isolation display ratio 50:1 or better).

f. Disconnect the termination from Channel 1 and connect it to the CH 2 input connector.

g. Set the CH 2 VOLTS/DIV switch to .1 V.

h. Set the generator for a two-division display (200 millivolts) at 50 megahertz.

i. Change the following control settings:

CH 1 VOLTS/DIV	10 mV
DISPLAY MODE	CH 1
CH 2 VOLTS/DIV	10 mV

j. CHECK—CRT display for 0.4 division or less deflection.

k. Disconnect all test equipment.

8. Check Common-Mode Rejection Ratio

a. Change the following control settings:

CH 1 and CH 2 VOLTS/DIV	20 mV
-------------------------	-------

b. Connect the medium-frequency generator to the CH 1 and CH 2 input connectors with the five-nanosecond GR cable, in-line 50-ohm GR termination, and the dual-input coupler.

c. Set the constant-amplitude generator for an eight-division display (160 millivolts) at 50 megahertz.

d. Change the following control settings:

DISPLAY MODE	ADD
CH 2 POLARITY	INVERT

e. CHECK—CRT display for 0.8 division or less deflection (common-mode rejection ratio 10:1 or better).

f. Disconnect all test equipment.

9. Check Alternate Operation

a. Set the DISPLAY MODE switch to ALT.

b. Position the traces about two divisions apart.

PART II-ADJUSTMENT

Introduction

The following procedure returns the 7A18 to correct calibration. All limits and tolerances given in this procedure are calibration guides, and should not be interpreted as instrument specifications except as listed in the Performance Requirement column of Section 1. The actual operation of the instrument may exceed the given limits or tolerances if the instrument meets the Performance Requirements as checked in Part I — Performance Check of this section.

Index to Part II — Adjustment

1. Adjust Channel 1 and 2 DC Balance	Page 5-7
2. Adjust Channel 1 and 2 GAIN	Page 5-8
3. Adjust Channel 1 and 2 Input Capacitance	Page 5-8
4. Adjust Channel 1 and 2 Attenuator Compensation	Page 5-9
5. Adjust Channel 1 and 2 High-Frequency Compensation	Page 5-10

Preliminary Procedure For Adjustment

NOTE

This instrument should be adjusted at an ambient temperature of 25°C ±5°C for best overall accuracy.

1. Remove the left side shield from the 7A18, and the left side panel from the Indicator Oscilloscope.
2. Install the 7A18 in the left vertical plug-in compartment of the Indicator Oscilloscope.
3. Connect the Indicator Oscilloscope to a power source which meets the frequency and voltage requirements of the oscilloscope power supply.
4. Turn the Indicator Oscilloscope power on. Allow at least twenty minutes warmup before proceeding.

5. Set the controls as given under Preliminary Control Settings.

6. Adjust the Focus and Astigmatism as necessary to obtain a well-defined display.

NOTE

Titles for external controls of this instrument are capitalized in this procedure (e.g., VOLTS/DIV). Internal adjustments are initial capitalized only (e.g., DC Balance).

Location of Adjustments

The locations of the 7A18 adjustments are shown in Fig. 5-1.

1. Adjust Channel 1 and 2 DC Balance

a. Position the trace to the center horizontal line with the CH 1 POSITION control.

b. Push and release the CH 1 VARIABLE (VOLTS/DIV) control to its outward position.

c. CHECK—Turn the VARIABLE control from fully counterclockwise to fully clockwise. Trace should not move more than 0.5 division vertically.

d. ADJUST—Channel 1 DC Balance, adjustment number 1, for minimum trace shift as the CH 1 VARIABLE control is rotated from fully counterclockwise to fully clockwise.

e. Set the CH 1 VARIABLE control to the CAL IN position.

f. Set the DISPLAY MODE switch to CH 2.

g. Position the trace to the center horizontal line with the CH 2 POSITION control.

h. Push and release the CH 2 VARIABLE control to its outward position. (For instruments B070000 and below.) Perform the following for instruments B070000 and up:

ADJUST—DC BAL (see number 5, Fig. 5-1) for no trace shift while switching CH 2 POLARITY switch from +UP to INVERT.

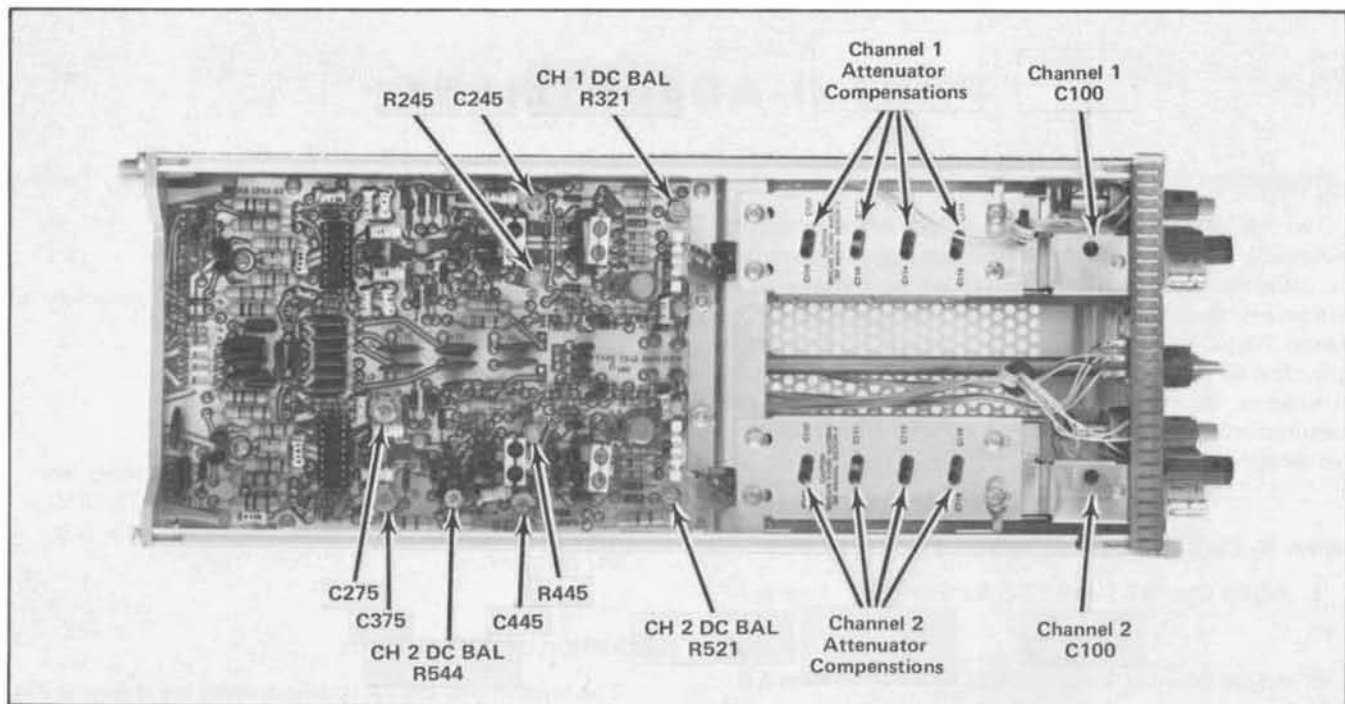

Fig. 5-1. Locations of adjustments used in this procedure. (7A18 shown.)

NOTE

Perform parts *i*, *j*, and *l* for 7A18N below SN B070000; 7A18 below SN B090000. Perform part *k* for 7A18N SN B070000 and up and 7A18 SN B090000 and up.

i. CHECK—Turn the VARIABLE control from fully counterclockwise to fully clockwise. Trace should not move more than 0.5 division vertically.

j. ADJUST—Channel 2 DC Balance, adjustment number 5, for minimum trace shift as the CH 2 VARIABLE control is rotated from fully counterclockwise to fully clockwise.

k. ADJUST—CH 2 VARIABLE DC BAL (R544, see number 9, Fig. 5-1) for minimum trace shift as the CH 2 VARIABLE control is rotated from fully counterclockwise to fully clockwise.

l. Set the CH 2 VARIABLE control to the CAL IN position.

2. Adjust Channel 1 and 2 GAIN

a. Connect the standard amplitude calibrator to the CH 2 input connector with the 42-inch BNC cable.

b. Set the standard amplitude calibrator for 50-millivolt square-wave output.

c. Position the display to the center of the graticule with the CH 2 POSITION control.

d. CHECK—CRT display for exactly five divisions in amplitude.

e. ADJUST—CH 2 GAIN adjustment (front panel) for exactly five divisions of deflection. To adjust, press in the

GAIN knob with a screwdriver and turn until the GAIN control is engaged.

f. Disconnect the standard amplitude calibrator from the CH 2 input connector and connect it to the CH 1 input connector.

g. Set the DISPLAY MODE switch to CH 1.

h. Position the display to the center of the graticule with the CH 1 POSITION control.

i. CHECK—CRT display for exactly five divisions in amplitude.

j. ADJUST—CH 1 GAIN adjustment (front panel) for exactly five divisions of deflection.

k. Disconnect all test equipment.

3. Adjust Channel 1 and 2 Input Capacitance

a. Remove the 7A18 from the Indicator Oscilloscope. Place the 7A18 on the plug-in extender and plug the extender into the left vertical compartment.

b. Set the CH 1 and CH 2 VOLTS/DIV switches to 5 mV.

c. Connect the square-wave generator high-amplitude output to the CH 1 input connector with the five-

nanosecond GR cable, 10X GR attenuator, in-line 50-ohm GR termination, and 20 pF normalizer.

d. Set the square-wave generator for a six-division display (30 millivolts) of a one-kilohertz signal.

e. Set the time-base unit for a triggered display at a sweep rate of .2 millisecond/division.

f. CHECK—CRT display for square-wave with square corner.

g. ADJUST—Channel 1 C100 for optimum square corner on the displayed waveform (use tuning tool).

h. Disconnect the normalizer from the CH 1 input connector and connect it to the CH 2 input connector.

i. Set the DISPLAY MODE switch to CH 2.

j. CHECK—CRT display for square-wave with square corner.

k. ADJUST—Channel 2 C100 for optimum square corner on the displayed waveform.

l. Disconnect all test equipment.

m. Remove the 7A18 and plug-in extender from the Indicator Oscilloscope. Install the 7A18 only in the left vertical compartment.

4. Adjust Attenuator Compensation

a. Connect the square-wave generator high-amplitude output to the CH 2 input connector with the five-nanosecond GR cable, 10X GR attenuator, in-line 50-ohm GR termination, and 20 pF normalizer.

b. Set the CH 1 and CH 2 VOLTS/DIV switches to 10 mV.

c. Set the square-wave generator for a six-division display (60 millivolts) of one-kilohertz signal.

d. CHECK—CRT display at each CH 2 VOLTS/DIV switch position listed in Table 5-2 for square corner and flat

top within 0.15 division. Re-adjust the generator output at each switch position to provide six divisions of deflection.

e. ADJUST—CH 2 attenuator compensations as given in Table 5-2 for optimum square corner and flat top on the displayed waveform (use tuning tool). Re-adjust the generator output at each switch position to provide six divisions of deflection.

f. Disconnect the normalizer from CH 2 and connect the signal to the CH 1 input connector.

g. Set the DISPLAY MODE switch to CH 1.

h. CHECK—CRT display at each CH 1 VOLTS/DIV switch position listed in Table 5-2 for square corner and flat top within 0.15 division. Re-adjust the generator output at each switch position to provide six divisions of deflection.

i. ADJUST—CH 1 attenuator compensations as given in Table 5-2 for optimum square corner and flat top on the displayed waveform. Re-adjust the generator output at each switch position to provide six divisions of deflection.

j. Disconnect all test equipment.

TABLE 5-2

Attenuator Compensation

VOLTS/DIV Switch Setting	Adjust for Optimum	
	Square Corner	Flat Top
10 mV	C106	C107
20 mV	C110	C111
50 mV	C114	C115
0.1 V	Check	Check

Remove 10X GR attenuator.

0.2 V	Check	Check
0.5 V	C118	C119
1 V	Check	Check

Replace in-line 50-ohm GR termination
with GR to BNC male adapter.

2 V	Check	Check
5 V	Check	Check

5. Adjust Channel 1 and 2 High-Frequency Compensation

a. Set the CH 1 and CH 2 VOLTS/DIV switches to 10 mV.

b. Connect the square-wave generator fast-rise output to the CH 1 input connector with the five-nanosecond GR cable, 10X GR attenuator, and in-line 50-ohm GR termination.

c. Set the square-wave generator for a six-division display (60 millivolts) of a 100 kilohertz signal.

d. Set the time-base unit for a triggered display at a sweep rate of 2 microseconds/division.

NOTE

In the following steps, change the time-base unit magnifier from X1 to X10 and compare the response at both sweep rates.

e. CHECK—CRT display for optimum square-wave response with aberrations not to exceed 0.24 division peak-to-peak.

f. ADJUST—Adjustments numbers 2, 3, and 4 for optimum square-wave response with minimum aberrations. Use the low-capacitance screwdriver to adjust the variable capacitors. Repeat these adjustments until optimum response is obtained.

g. Disconnect the termination from the CH 1 input connector and connect it to the CH 2 input connector.

h. Set the DISPLAY MODE switch to CH 2.

i. CHECK—CRT display for optimum square-wave response with aberrations not to exceed 0.24 division peak-to-peak.

j. ADJUST—Adjustments numbers 6, 7, and 8 for optimum square-wave response with minimum aberrations. Use the low-capacitance screwdriver to adjust the variable capacitors. Repeat these adjustments until optimum response is obtained.

This completes the Calibration of the 7A18. Disconnect all test equipment. Replace the left side shield on the 7A18 and the left side panel on the Indicator Oscilloscope.

REPLACEABLE ELECTRICAL PARTS

PARTS ORDERING INFORMATION

Replacement parts are available from or through your local Tektronix, Inc. Field Office or representative.

Changes to Tektronix instruments are sometimes made to accommodate improved components as they become available, and to give you the benefit of the latest circuit improvements developed in our engineering department. It is therefore important, when ordering parts, to include the following information in your order: Part number, instrument type or number, serial number, and modification number if applicable.

If a part you have ordered has been replaced with a new or improved part, your local Tektronix, Inc. Field Office or representative will contact you concerning any change in part number.

Change information, if any, is located at the rear of this manual.

SPECIAL NOTES AND SYMBOLS

X000 Part first added at this serial number
00X Part removed after this serial number

ITEM NAME

In the Parts List, an Item Name is separated from the description by a colon (:). Because of space limitations, an Item Name may sometimes appear as incomplete. For further Item Name identification, the U.S. Federal Cataloging Handbook H6-1 can be utilized where possible.

ABBREVIATIONS

ACTR	ACTUATOR	PLSTC	PLASTIC
ASSY	ASSEMBLY	QTZ	QUARTZ
CAP	CAPACITOR	RECP	RECEPTACLE
CER	CERAMIC	RES	RESISTOR
CKT	CIRCUIT	RF	RADIO FREQUENCY
COMP	COMPOSITION	SEL	SELECTED
CONN	CONNECTOR	SEMICOND	SEMICONDUCTOR
ELCTLT	ELECTROLYTIC	SENS	SENSITIVE
ELEC	ELECTRICAL	VAR	VARIABLE
INCAND	INCANDESCENT	WW	WIREWOUND
LED	LIGHT EMITTING DIODE	XFMR	TRANSFORMER
NONWIR	NON WIREWOUND	XTAL	CRYSTAL

CROSS INDEX MFR. CODE NUMBER TO MANUFACTURER

MFR.CODE	MANUFACTURER	ADDRESS	CITY,STATE,ZIP
01121	ALLEN-BRADLEY CO.	1201 2ND ST. SOUTH	MILWAUKEE, WI 53204
03508	GENERAL ELECTRIC CO., SEMI-CONDUCTOR PRODUCTS DEPT.	ELECTRONICS PARK	SYRACUSE, NY 13201
04222	AVX CERAMIC CORP.	P.O. BOX 867	MURTL BEACH, SC 29577
07263	FAIRCHILD SEMICONDUCTOR, A DIV. OF FAIRCHILD CAMERA AND INSTRUMENT CORP.	464 ELLIS ST.	MOUNTAIN VIEW, CA 94042
07910	TELEDYNE SEMICONDUCTOR	12515 CHADRON AVE.	HAWTHORNE, CA 90250
12697	CLAROSTAT MFG. CO., INC.	LOWER WASHINGTON ST.	DOVER, NH 03820
17856	SILICONIX, INC.	2201 LAURELWOOD RD.	SANTA CLARA, CA 95054
24931	SPECIALTY CONNECTOR CO., INC.	3560 MADISON AVE.	INDIANAPOLIS, IN 46227
36619	MICROWAVE INSTRUMENTS & COMPONENTS, INC.	6600 BOMBARDIER ST.	MONTREAL 458 QUE CAN
56289	SPRAGUE ELECTRIC CO.		NORTH ADAMS, MA 01247
71590	CENTRALAB ELECTRONICS, DIV. OF GLOBE-UNION, INC.	5757 N. GREEN BAY AVE.	MILWAUKEE, WI 53201
72982	ERIE TECHNOLOGICAL PRODUCTS, INC.	644 W. 12TH ST.	ERIE, PA 16512
74970	JOHNSON, E. F., CO.	299 10TH AVE. S. W.	WASECA, MN 56093
75042	TRW ELECTRONIC COMPONENTS, IRC FIXED RESISTORS, PHILADELPHIA DIVISION	401 N. BROAD ST.	PHILADELPHIA, PA 19108
76854	OAK INDUSTRIES, INC., SWITCH DIV.	S. MAIN ST.	CRYSTAL LAKE, IL 60014
78488	STACKPOLE CARBON CO.		ST. MARYS, PA 15857
79727	C-W INDUSTRIES	550 DAVISVILLE RD.	WARMINSTER, PA 18974
80009	TEKTRONIX, INC.	P. O. BOX 500	BEAVERTON, OR 97077
80740	BECKMAN INSTRUMENTS, INC.	2500 HARBOR BLVD.	FULLERTON, CA 92634

Ckt No.	Tektronix Part No.	Serial/Model No. Eff	Dscont	Name & Description	Mfr Code	Mfr Part Number
CHASSIS						
C9 ¹	283-0000-00			CAP., FXD, CER DI:0.001UF,+100-0%,500V	72982	831-516E102P
C10	285-0816-01			CAP., FXD, PLSTC:0.19UF,10%,600V	80009	285-0816-01
C13 ¹	283-0000-00			CAP., FXD, CER DI:0.001UF,+100-0%,500V	72982	831-516E102P
C19 ¹	283-0000-00			CAP., FXD, CER DI:0.001UF,+100-0%,500V	72982	831-516E102P
C20	285-0816-01			CAP., FXD, PLSTC:0.19UF,10%,600V	80009	285-0816-01
C23 ¹	283-0000-00			CAP., FXD, CER DI:0.001UF,+100-0%,500V	72982	831-516E102P
C106 ¹	307-1010-00	B010100	B039999	ATTENUATOR,FXD:2X	80009	307-1010-00
C106 ¹	307-1010-01	B040000		ATTENUATOR,FXD:2X	80009	307-1010-01
C106 ²	307-1010-00	B020100	B029999	ATTENUATOR,FXD:2X	80009	307-1010-00
C106 ²	307-1010-01	B030000		ATTENUATOR,FXD:2X	80009	307-1010-01
C107 ¹	307-1010-00	B010100	B039999	ATTENUATOR,FXD:2X	80009	307-1010-00
C107 ¹	307-1010-01	B040000		ATTENUATOR,FXD:2X	80009	307-1010-01
C107 ²	307-1010-00	B020100	B029999	ATTENUATOR,FXD:2X	80009	307-1010-00
C107 ²	307-1010-01	B030000		ATTENUATOR,FXD:2X	80009	307-1010-01
C110	307-1011-00			ATTENUATOR,FXD:4X	80009	307-1011-00
C111	307-1011-00			ATTENUATOR,FXD:4X	80009	307-1011-00
C114 ¹	307-1013-00	B010100	B039999	ATTENUATOR,FXD:10X	80009	307-1013-00
C114 ¹	307-1013-01	B040000		ATTENUATOR,FXD:10X	80009	307-1013-01
C114 ²	307-1013-00	B020100	B029999	ATTENUATOR,FXD:10X	80009	307-1013-00
C114 ²	307-1013-01	B030000		ATTENUATOR,FXD:10X	80009	307-1013-01
C115 ¹	307-1013-00	B010100	B039999	ATTENUATOR,FXD:10X	80009	307-1013-00
C115 ¹	307-1013-01	B040000		ATTENUATOR,FXD:10X	80009	307-1013-01
C115 ²	307-1013-00	B020100	B029999	ATTENUATOR,FXD:10X	80009	307-1013-00
C115 ²	307-1013-01	B030000		ATTENUATOR,FXD:10X	80009	307-1013-01
C118 ¹	307-1014-00	B010100	B039999	ATTENUATOR,FXD:100X	80009	307-1014-00
C118 ¹	307-1014-01	B040000		ATTENUATOR,FXD:100X	80009	307-1014-01
C118 ²	307-1014-00	B020100	B029999	ATTENUATOR,FXD:100X	80009	307-1014-00
C118 ²	307-1014-01	B030000		ATTENUATOR,FXD:100X	80009	307-1014-01
C119 ¹	307-1014-00	B010100	B039999	ATTENUATOR,FXD:100X	80009	307-1014-00
C119 ¹	307-1014-01	B040000		ATTENUATOR,FXD:100X	80009	307-1014-01
C119 ²	307-1014-00	B020100	B029999	ATTENUATOR,FXD:100X	80009	307-1014-00
C119 ²	307-1014-01	B030000		ATTENUATOR,FXD:100X	80009	307-1014-01
C238 ¹	281-0504-00	B010100	B079999X	CAP.,FXD,CER DI:10PF,+/-1PF,500V	72982	301-055C0G0100F
C238 ²	281-0504-00	B020100	B059999X	CAP.,FXD,CER DI:10PF,+/-1PF,500V	72982	301-055C0G0100F
C438 ¹	281-0504-00	B010100	B079999X	CAP.,FXD,CER DI:10PF,+/-1PF,500V	72982	301-055C0G0100F
C438 ²	281-0504-00	B020100	B059999X	CAP.,FXD,CER DI:10PF,+/-1PF,500V	72982	301-055C0G0100F
J10 ¹	131-0679-00			CONNECTOR,RCPT,:BNC W/HARDWARE	24931	28JR168-1
J10 ²	131-0126-00			CONNECTOR,RCPT,:BNC,FEMALE	36619	9663-1 NT-34
J20 ¹	131-0679-00			CONNECTOR,RCPT,:BNC W/HARDWARE	24931	28JR168-1
J20 ²	131-0126-00			CONNECTOR,RCPT,:BNC,FEMALE	36619	9663-1 NT-34
L237 ¹	276-0507-00	B010100	B079999X	SHIELDING BEAD,:0.6UH	78488	57-0180-7D
L237 ²	276-0507-00	B020100	B059999X	SHIELDING BEAD,:0.6UH	78488	57-0180-7D
L437 ¹	276-0507-00	B010100	B079999X	SHIELDING BEAD,:0.6UH	78488	57-0180-7D
L437 ²	276-0507-00	B020100	B059999X	SHIELDING BEAD,:0.6UH	78488	57-0180-7D
R10	315-0620-00			RES.,FXD,CMPSN:62 OHM,5%,0.25W	01121	CB6205
R11 ³	311-0880-01	B010100	B029999	RES.,VAR,NONWIR:5K OHM,20%,0.50W	71590	BA202-001
R11 ³	311-1320-00	B030000		RES.,VAR,NONWIR:5K OHM,10%,1W	12697	381-CM39700
R11 ²	311-0310-00			RES.,VAR,NONWIR:5K OHM,20%,0.50W	01121	W-7350A
R13 ¹	317-0910-00			RES.,FXD,CMPSN:91 OHM,5%,0.125W	01121	BB9105
R20	315-0620-00			RES.,FXD,CMPSN:62 OHM,5%,0.25W	01121	CB6205

¹7A18 only.

²7A18N only.

³Furnished as a unit with S13, 7A18 only.

Electrical Parts List—7A18/7A18N

Ckt No.	Tektronix Part No.	Serial/Model No. Eff	Dscont	Name & Description	Mfr Code	Mfr Part Number
R21 ¹	311-0880-01	B010100	B029999	RES.,VAR, NONWIR:5K OHM,20%,0.50W	71590	BA202-001
R21 ¹	311-1320-00	B030000		RES.,VAR, NONWIR:5K OHM,10%,1W	12697	381-CM39700
R21 ²	311-0310-00			RES.,VAR, NONWIR:5K OHM,20%,0.50W	01121	W-7350A
R23 ³	317-0910-00			RES.,FXD, CMPSN:91 OHM,5%,0.125W	01121	BB9105
R35	315-0241-00			RES.,FXD, CMPSN:240 OHM,5%,0.25W	01121	CB2415
R36	315-0621-00			RES.,FXD, CMPSN:620 OHM,5%,0.25W	01121	CB6215
R38	315-0392-00			RES.,FXD, CMPSN:3.9K OHM,5%,0.25W	01121	CB3925
R236	315-0621-00			RES.,FXD, CMPSN:620 OHM,5%,0.25W	01121	CB6215
R237A,B ⁴	311-1131-01			RES.,VAR, NONWIR:5K OHM,10%,0.25W	80009	311-1131-01
R238 ³	315-0131-00	B010100	B079999	RES.,FXD, CMPSN:130 OHM,5%,0.25W	01121	CB1315
R238 ³	315-0390-00	B080000		RES.,FXD, CMPSN:39 OHM,5%,0.25W	01121	CB3905
R238 ²	315-0131-00	B020100	B059999	RES.,FXD, CMPSN:130 OHM,5%,0.25W	01121	CB1315
R238 ²	315-0390-00	B060000		RES.,FXD, CMPSN:39 OHM,5%,0.25W	01121	CB3905
R239 ³	315-0222-00	XB080000		RES.,FXD, CMPSN:2.2K OHM,5%,0.25W	01121	CB2225
R239 ²	315-0222-00	XB060000		RES.,FXD, CMPSN:2.2K OHM,5%,0.25W	01121	CB2225
R436	315-0621-00			RES.,FXD, CMPSN:620 OHM,5%,0.25W	01121	CB6215
R437A,B ⁵	311-1131-01			RES.,VAR, NONWIR:5K OHM,10%,0.25W	80009	311-1131-01
R438 ³	315-0131-00	B010100	B079999	RES.,FXD, CMPSN:130 OHM,5%,0.25W	01121	CB1315
R438 ³	315-0390-00	B080000		RES.,FXD, CMPSN:39 OHM,5%,0.25W	01121	CB3905
R438 ²	315-0131-00	B020100	B059999	RES.,FXD, CMPSN:130 OHM,5%,0.25W	01121	CB1315
R438 ²	315-0390-00	B060000		RES.,FXD, CMPSN:39 OHM,5%,0.25W	01121	CB3905
R439 ³	315-0222-00	XB080000		RES.,FXD, CMPSN:2.2K OHM,5%,0.25W	01121	CB2225
R439 ²	315-0222-00	XB060000		RES.,FXD, CMPSN:2.2K OHM,5%,0.25W	01121	CB2225
S13 ⁶						
S22	260-0816-00			SWITCH,SLIDE:DPDT,0.5A,125VAC	79727	GF-126-0012A
S23 ⁷						
S30A,B	262-0926-00			SWITCH,ROTARY:DISPLAY MODE/TRIG SCE (WIRED)	80009	262-0926-00
S30A,B	260-1221-00			SWITCH,ROTARY:DISPLAY MODE/TRIG SCE	76854	5-41981-411
S237 ^{3,8}	262-0928-00	B010100	B079999	SWITCH,ROTARY:CAL IN CH1 (WIRED)	80009	262-0928-00
S237 ^{3,8}	262-0928-01	B080000		SWITCH,ROTARY:CAL IN CH1 (WIRED)	80009	262-0928-01
S237 ^{2,8}	262-0928-00	B020100	B059999	SWITCH,ROTARY:CAL IN CH1 (WIRED)	80009	262-0928-00
S237 ^{2,8}	262-0928-01	B060000		SWITCH,ROTARY:CAL IN CH1 (WIRED)	80009	262-0928-01
S437 ^{3,9}	262-0928-00	B010100	B079999	SWITCH,ROTARY:CAL IN CH2 (WIRED)	80009	262-0928-00
S437 ^{3,9}	262-0928-01	B080000		SWITCH,ROTARY:CAL IN CH2 (WIRED)	80009	262-0928-01
S437 ^{2,9}	262-0928-00	B020100	B059999	SWITCH,ROTARY:CAL IN CH2 (WIRED)	80009	262-0928-00
S437 ^{2,9}	262-0928-01	B060000		SWITCH,ROTARY:CAL IN CH2 (WIRED)	80009	262-0928-01
T11 ³	276-0549-00	B010100	B039999	CORE,FERRITE:0.210 ID X 0.437" OD	01121	T0437C416A
T11 ³	276-0525-00	B040000		CORE,FERRITE:0.196 ID X 0.437" OD	01121	T037C351A
T11 ²	276-0549-00	B020100	B029999	CORE,FERRITE:0.210 ID X 0.437" OD	01121	T0437C416A
T11 ²	276-0525-00	B030000		CORE,FERRITE:0.196 ID X 0.437" OD	01121	T037C351A
T21 ³	276-0549-00	B010100	B039999	CORE,FERRITE:0.210 ID X 0.437" OD	01121	T0437C416A
T21 ³	276-0525-00	B040000		CORE,FERRITE:0.196 ID X 0.437" OD	01121	T037C351A
T21 ²	276-0549-00	B020100	B029999	CORE,FERRITE:0.210 ID X 0.437" OD	01121	T0437C416A
T21 ²	276-0525-00	B030000		CORE,FERRITE:0.196 ID X 0.437" OD	01121	T037C351A
A1 ³	672-0020-00	B010100	B059999	CKT BOARD ASSY:READOUT CAM SW ATTENUATOR (2)	80009	672-0020-00
A1 ³	672-0020-01	B060000	B099999	CKT BOARD ASSY:READOUT CAM SW ATTENUATOR (2)	80009	672-0020-01
A1 ³	672-0020-02	B100000		CKT BOARD ASSY:READOUT CAM SW ATTENUATOR (2)	80009	672-0020-02
A1A ³	670-1706-01	XB100000	B119999	CKT BOARD ASSY:ATTENUATOR	80009	670-1706-01
A1A ³	670-1706-02	B120000		CKT BOARD ASSY:ATTENUATOR	80009	670-1706-02
A1 ²	670-1386-00	B020100	B049999	CKT BOARD ASSY:ATTENUATOR (2)	80009	670-1386-00

¹Furnished as a unit with S23, 7A18 only.

²7A18N only.

³7A18 only.

⁴Furnished as a unit with S237.

⁵Furnished as a unit with S437.

⁶Furnished as a unit with R11,7A18 only.

⁷Furnished as a unit with R21,7A18 only.

⁸Furnished as a unit with R237A,B.

⁹Furnished as a unit with R437A,B.

Ckt No.	Tektronix Part No.	Serial/Model No. Eff	Dscont	Name & Description	Mfr Code	Mfr Part Number
A1 ¹	670-1386-03	B050000	B085868	CKT BOARD ASSY:ATTENUATOR (2)	80009	670-1386-03
A1 ¹	672-0480-00	B085869		CKT BOARD ASSY:CAM SW ATTENUATOR(2)	80009	672-0480-00
C100	281-0064-00			CAP.,VAR,PLSTC:0.25-1.5PF,600V	72982	530-002
C101 ²	281-0661-00	B010100	B029999X	CAP.,FXD,CER DI:0.8PF,+/-0.1PF,500V	72982	301-000COK0808B
R102	317-0105-00			RES.,FXD,CMPSN:1M OHM,5%,0.125W	01121	BB1055
R130	322-0481-00			RES.,FXD,FILM:1M OHM,1%,0.25W	75042	CEBT0-1004F
S100A ^{3,2}	105-0242-00	B010100	B059999	ACTUATOR CAM SW:AC/GND/DC	80009	105-0242-00
S100A ^{3,2}	105-0242-01	B060000	B099999	ACTUATOR CAM SW:AC/GND/DC	80009	105-0242-01
S100A ^{3,2}	105-0242-02	B100000		ACTUATOR CAM SW:AC/GND/DC	80009	105-0242-02
S100A ^{3,1}	105-0242-00	B020100	B049999	ACTUATOR,CAM SW:AC/GND/DC	80009	105-0242-00
S100A ^{3,1}	105-0242-01	B050000	B085868	ACTUATOR,CAM SW:AC/GND/DC	80009	105-0242-01
S100A ^{3,1}	105-0242-02	B085869		ACTUATOR,CAM SW:AC/GND/DC	80009	105-0242-02
S100B ^{3,2}	105-0241-00	B010100	B059999	ACTUATOR CAM SW:VOLTS/DIV	80009	105-0241-00
S100C						
S100B ^{3,2}	105-0241-01	B060000		ACTUATOR CAM SW:VOLTS/DIV	80009	105-0241-01
S100C						
S100B ^{3,1}	105-0241-00	B020100	B049999	ACTUATOR,CAM SW:VOLTS/DIV	80009	105-0241-00
S100C						
S100B ^{3,1}	105-0241-01	B050000		ACTUATOR,CAM SW:VOLTS/DIV	80009	105-0241-01
S100C						
A2 ²	670-1384-00	B010100	B069999	CKT BOARD ASSY:AMPLIFIER	80009	670-1384-00
A2 ²	670-1384-02	B070000	B079999	CKT BOARD ASSY:AMPLIFIER	80009	670-1384-02
A2 ²	670-1384-03	B080000	B119999	CKT BOARD ASSY:AMPLIFIER	80009	670-1384-03
A2 ²	670-1384-07	B120000		CKT BOARD ASSY:AMPLIFIER	80009	670-1384-07
A2 ¹	670-1384-00	B020100	B059999	CKT BOARD ASSY:AMPLIFIER	80009	670-1384-00
A2 ¹	670-1384-03	B060000	B085749	CKT BOARD ASSY:AMPLIFIER	80009	670-1384-03
A2 ¹	670-1384-06	B085750		CKT BOARD ASSY:AMPLIFIER	80009	670-1384-06
A2 ⁴	670-1384-01			CKT BOARD ASSY:AMPLIFIER	80009	670-1384-01
A2 ⁵	670-1384-04	XB100000	B119999	CKT BOARD ASSY:AMPLIFIER	80009	670-1384-04
A2 ⁵	670-1384-08	B120000		CKT BOARD ASSY:AMPLIFIER	80009	670-1384-08
C210	283-0001-00			CAP.,FXD,CER DI:0.005UF,+100-0%,500V	72982	831-559E502P
C212	281-0557-00			CAP.,FXD,CER DI:1.8PF,10%,500V	72982	301-000COK0189B
C216	290-0512-00			CAP.,FXD,ELCTLT:22UF,20%,15V	56289	196D226X0015KAL
C225 ²	281-0638-00	B010100	B079999	CAP.,FXD,CER DI:240PF,5%,500V	72982	301000Z5D241J
C225 ²	283-0067-00	B080000		CAP.,FXD,CER DI:0.001UF,10%,200V	72982	835-515B102K
C225 ¹	281-0638-00	B020100	B059999	CAP.,FXD,CER DI:240PF,5%,500V	72982	301000Z5D241J
C225 ¹	283-0067-00	B060000		CAP.,FXD,CER DI:0.001UF,10%,200V	72982	835-515B102K
C237	283-0000-00			CAP.,FXD,CER DI:0.001UF,+100-0%,500V	72982	831-516E102P
C241 ²	281-0580-00	B010100	B079999	CAP.,FXD,CER DI:470PF,10%,500V	04222	7001-1374
C241 ²	283-0067-00	B080000		CAP.,FXD,CER DI:0.001UF,10%,200V	72982	835-515B102K
C241 ¹	281-0580-00	B020100	B059999	CAP.,FXD,CER DI:470PF,10%,500V	04222	7001-1374
C241 ¹	283-0067-00	B060000		CAP.,FXD,CER DI:0.001UF,10%,200V	72982	835-515B102K
C245	281-0153-00			CAP.,VAR,AIR DI:1.7-10PF,250V	74970	187-0106-005
C246	281-0512-00			CAP.,FXD,CER DI:27PF,+/-2.7PF,500V	72982	308-000C0G0270K
C256	283-0000-00			CAP.,FXD,CER DI:0.001UF,+100-0%,500V	72982	831-516E102P
C264	281-0600-00			CAP.,FXD,CER DI:35PF,10%,500V	72982	308-000C0G0350K
C270	283-0000-00			CAP.,FXD,CER DI:0.001UF,+100-0%,500V	72982	831-516E102P
C274	281-0592-00			CAP.,FXD,CER DI:4.7PF,+/-0.5PF,500V	72982	301-023C0H0479D
C275	281-0153-00			CAP.,VAR,AIR DI:1.7-10PF,250V	74970	187-0106-005
C278	281-0523-00			CAP.,FXD,CER DI:100PF,+/-20PF,500V	72982	301-000U2M0101M
C313	283-0000-00			CAP.,FXD,CER DI:0.001UF,+100-0%,500V	72982	831-516E102P
C318	290-0512-00			CAP.,FXD,ELCTLT:22UF,20%,15V	56289	196D226X0015KAL
C325 ²	281-0638-00	B010100	B079999	CAP.,FXD,CER DI:240PF,5%,500V	72982	301000Z5D241J
C325 ²	283-0067-00	B080000		CAP.,FXD,CER DI:0.001UF,10%,200V	72982	835-515B102K
C325 ¹	281-0638-00	B020100	B059999	CAP.,FXD,CER DI:240PF,5%,500V	72982	301000Z5D241J
C325 ¹	283-0067-00	B060000		CAP.,FXD,CER DI:0.001UF,10%,200V	72982	835-515B102K
C341 ²	281-0580-00	B010100	B079999	CAP.,FXD,CER DI:470PF,10%,500V	04222	7001-1374

17A18N only.
27A18 only.

³See Mechanical Parts List for replacement parts. ⁵7A18 Option 6 only.
⁴7A18 Option 1 only.

Electrical Parts List—7A18/7A18N

Ckt No.	Tektronix		Serial/Model No.		Name & Description	Mfr	
	Part No.	Eff	Dscont			Code	Mfr Part Number
C341 ¹	283-0067-00	B080000			CAP.,FXD,CER DI:0.001UF,10%,200V	72982	835-515B102K
C341 ²	281-0580-00	B020100	B059999		CAP.,FXD,CER DI:470PF,10%,500V	04222	7001-1374
C341 ²	283-0067-00	B060000			CAP.,FXD,CER DI:0.001UF,10%,200V	72982	835-515B102K
C345 ¹	281-0578-00	B010100	B079999		CAP.,FXD,CER DI:18PF,5%,500V	72982	301-050C0G0180J
C345 ¹	283-0067-00	B080000			CAP.,FXD,CER DI:0.001UF,10%,200V	72982	835-515B102K
C345 ²	281-0578-00	B020100	B059999		CAP.,FXD,CER DI:18PF,5%,500V	72982	301-050C0G0180J
C345 ²	283-0067-00	B060000			CAP.,FXD,CER DI:0.001UF,10%,200V	72982	835-515B102K
C356	283-0000-00				CAP.,FXD,CER DI:0.001UF,+100-0%,500V	72982	831-516E102P
C364	281-0600-00				CAP.,FXD,CER DI:35PF,10%,500V	72982	308-000C0G0350K
C370	283-0000-00				CAP.,FXD,CER DI:0.001UF,+100-0%,500V	72982	831-516E102P
C374	281-0592-00				CAP.,FXD,CER DI:4.7PF,+/-0.5PF,500V	72982	301-023C0H0479D
C375	281-0153-00				CAP.,VAR,AIR DI:1.7-10PF,250V	74970	187-0106-005
C378	281-0523-00				CAP.,FXD,CER DI:100PF,+/-20PF,500V	72982	301-000U2M0101M
C391	283-0002-00				CAP.,FXD,CER DI:0.01UF,+80-20%,500V	72982	811-546E103Z
C392	283-0002-00				CAP.,FXD,CER DI:0.01UF,+80-20%,500V	72982	811-546E103Z
C393	283-0002-00				CAP.,FXD,CER DI:0.01UF,+80-20%,500V	72982	811-546E103Z
C394	283-0002-00				CAP.,FXD,CER DI:0.01UF,+80-20%,500V	72982	811-546E103Z
C395	283-0002-00				CAP.,FXD,CER DI:0.01UF,+80-20%,500V	72982	811-546E103Z
C396	283-0002-00				CAP.,FXD,CER DI:0.01UF,+80-20%,500V	72982	811-546E103Z
C397	283-0002-00				CAP.,FXD,CER DI:0.01UF,+80-20%,500V	72982	811-546E103Z
C398	283-0002-00				CAP.,FXD,CER DI:0.01UF,+80-20%,500V	72982	811-546E103Z
C410	283-0001-00				CAP.,FXD,CER DI:0.005UF,+100-0%,500V	72982	831-559E502P
C412	281-0557-00				CAP.,FXD,CER DI:1.8PF,10%,500V	72982	301-000C0K0189B
C416	290-0512-00				CAP.,FXD,ELCTLT:22UF,20%,15V	56289	196D226X0015KA1
C425 ¹	281-0638-00	B010100	B079999		CAP.,FXD,CER DI:240PF,5%,500V	72982	30100025D241J
C425 ¹	283-0067-00	B080000			CAP.,FXD,CER DI:0.001UF,10%,200V	72982	835-515B102K
C425 ²	281-0638-00	B020100	B059999		CAP.,FXD,CER DI:240PF,5%,500V	72982	30100025D241J
C425 ²	283-0067-00	B060000			CAP.,FXD,CER DI:0.001UF,10%,200V	72982	835-515B102K
C427	283-0000-00				CAP.,FXD,CER DI:0.001UF,+100-0%,500V	72982	831-516E102P
C429	283-0000-00				CAP.,FXD,CER DI:0.001UF,+100-0%,500V	72982	831-516E102P
C441 ¹	281-0580-00	B010100	B079999		CAP.,FXD,CER DI:470PF,10%,500V	04222	7001-1374
C441 ¹	283-0067-00	B080000			CAP.,FXD,CER DI:0.001UF,10%,200V	72982	835-515B102K
C441 ²	281-0580-00	B020100	B059999		CAP.,FXD,CER DI:470PF,10%,500V	04222	7001-1374
C441 ²	283-0067-00	B060000			CAP.,FXD,CER DI:0.001UF,10%,200V	72982	835-515B102K
C445	281-0153-00				CAP.,VAR,AIR DI:1.7-10PF,250V	74970	187-0106-005
C446 ¹	281-0578-00	B010100	B079999		CAP.,FXD,CER DI:18PF,5%,500V	72982	301-050C0G0180J
C446 ¹	283-0067-00	B080000			CAP.,FXD,CER DI:0.001UF,10%,200V	72982	835-515B102K
C446 ²	281-0578-00	B020100	B059999		CAP.,FXD,CER DI:18PF,5%,500V	72982	301-050C0G0180J
C446 ²	283-0067-00	B060000			CAP.,FXD,CER DI:0.001UF,10%,200V	72982	835-515B102K
C456	283-0000-00				CAP.,FXD,CER DI:0.001UF,+100-0%,500V	72982	831-516E102P
C457	283-0000-00				CAP.,FXD,CER DI:0.001UF,+100-0%,500V	72982	831-516E102P
C464	281-0600-00				CAP.,FXD,CER DI:35PF,10%,500V	72982	308-000C0G0350K
C470	283-0000-00				CAP.,FXD,CER DI:0.001UF,+100-0%,500V	72982	831-516E102P
C474	281-0592-00				CAP.,FXD,CER DI:4.7PF,+/-0.5PF,500V	72982	301-023C0H0479D
C475	281-0503-00				CAP.,FXD,CER DI:8PF,+/-0.5PF,500V	72982	301-000C0H0809D
C478	281-0523-00				CAP.,FXD,CER DI:100PF,+/-20PF,500V	72982	301-000U2M0101M
C513	283-0000-00				CAP.,FXD,CER DI:0.001UF,+100-0%,500V	72982	831-516E102P
C518	290-0512-00				CAP.,FXD,ELCTLT:22UF,20%,15V	56289	196D226X0015KA1
C525 ¹	281-0638-00	B010100	B079999		CAP.,FXD,CER DI:240PF,5%,500V	72982	30100025D241J
C525 ¹	283-0067-00	B080000			CAP.,FXD,CER DI:0.001UF,10%,200V	72982	835-515B102K
C525 ²	281-0638-00	B020100	B059999		CAP.,FXD,CER DI:240PF,5%,500V	72982	30100025D241J
C525 ²	283-0067-00	B060000			CAP.,FXD,CER DI:0.001UF,10%,200V	72982	835-515B102K
C527	283-0000-00				CAP.,FXD,CER DI:0.001UF,+100-0%,500V	72982	831-516E102P

¹7A18 only.

²7A18N only.

Ckt No.	Tektronix Part No.	Serial/Model No. Eff	Dscont	Name & Description	Mfr Code	Mfr Part Number
C541 ¹	281-0580-00	B010100	B079999	CAP., FXD, CER DI: 470PF, 10%, 500V	04222	7001-1374
C541 ¹	283-0067-00	B080000		CAP., FXD, CER DI: 0.001UF, 10%, 200V	72982	835-515B102K
C541 ²	281-0580-00	B020100	B059999	CAP., FXD, CER DI: 470PF, 10%, 500V	04222	7001-1374
C541 ²	283-0067-00	B060000		CAP., FXD, CER DI: 0.001UF, 10%, 200V	72982	835-515B102K
C545	281-0512-00			CAP., FXD, CER DI: 27PF, +/-2.7PF, 500V	72982	308-000COG0270K
C556	283-0000-00			CAP., FXD, CER DI: 0.001UF, +100-0%, 500V	72982	831-516E102P
C564	281-0600-00			CAP., FXD, CER DI: 35PF, 10%, 500V	72982	308-000COG0350K
C570	283-0000-00			CAP., FXD, CER DI: 0.001UF, +100-0%, 500V	72982	831-516E102P
C574	281-0592-00			CAP., FXD, CER DI: 4.7PF, +/-0.5PF, 500V	72982	301-023COH0479D
C575	281-0503-00			CAP., FXD, CER DI: 8PF, +/-0.5PF, 500V	72982	301-000COH0809D
C578	281-0523-00			CAP., FXD, CER DI: 100PF, +/-20PF, 500V	72982	301-000U2M0101M
C584	283-0000-00			CAP., FXD, CER DI: 0.001UF, +100-0%, 500V	72982	831-516E102P
C591	283-0002-00			CAP., FXD, CER DI: 0.01UF, +80-20%, 500V	72982	811-546E103Z
C592	283-0002-00			CAP., FXD, CER DI: 0.01UF, +80-20%, 500V	72982	811-546E103Z
C593	283-0002-00			CAP., FXD, CER DI: 0.01UF, +80-20%, 500V	72982	811-546E103Z
C594	283-0002-00			CAP., FXD, CER DI: 0.01UF, +80-20%, 500V	72982	811-546E103Z
C595	283-0002-00			CAP., FXD, CER DI: 0.01UF, +80-20%, 500V	72982	811-546E103Z
C596	283-0002-00			CAP., FXD, CER DI: 0.01UF, +80-20%, 500V	72982	811-546E103Z
CR210	152-0321-00			SEMICONV DEVICE: SILICON, 35V, 100MA	07263	FSA1480
CR220	152-0185-00			SEMICONV DEVICE: SILICON, 40PIV, 150MA	07910	1N4152
CR221	152-0185-00			SEMICONV DEVICE: SILICON, 40PIV, 150MA	07910	1N4152
CR357	152-0185-00			SEMICONV DEVICE: SILICON, 40PIV, 150MA	07910	1N4152
CR410	152-0321-00			SEMICONV DEVICE: SILICON, 35V, 100MA	07263	FSA1480
CR420	152-0185-00			SEMICONV DEVICE: SILICON, 40PIV, 150MA	07910	1N4152
CR421	152-0185-00			SEMICONV DEVICE: SILICON, 40PIV, 150MA	07910	1N4152
CR557	152-0185-00			SEMICONV DEVICE: SILICON, 40PIV, 150MA	07910	1N4152
LR391	108-0184-00			COIL, RF: 3.2UF (WOUND ON A 10 OHM, 5%, 0.5W RES)	80009	108-0184-00
LR393	108-0184-00			COIL, RF: 3.2UF (WOUND ON A 10 OHM, 5%, 0.5W RES)	80009	108-0184-00
LR395	108-0184-00			COIL, RF: 3.2UF (WOUND ON A 10 OHM, 5%, 0.5W RES)	80009	108-0184-00
LR396	108-0184-00			COIL, RF: 3.2UF (WOUND ON A 10 OHM, 5%, 0.5W RES)	80009	108-0184-00
LR397	108-0184-00			COIL, RF: 3.2UF (WOUND ON A 10 OHM, 5%, 0.5W RES)	80009	108-0184-00
LR591	108-0184-00			COIL, RF: 3.2UF (WOUND ON A 10 OHM, 5%, 0.5W RES)	80009	108-0184-00
LR592	108-0184-00			COIL, RF: 3.2UF (WOUND ON A 10 OHM, 5%, 0.5W RES)	80009	108-0184-00
LR595	108-0184-00			COIL, RF: 3.2UF (WOUND ON A 10 OHM, 5%, 0.5W RES)	80009	108-0184-00
LR596	108-0184-00			COIL, RF: 3.2UF (WOUND ON A 10 OHM, 5%, 0.5W RES)	80009	108-0184-00
Q210A,B	151-1032-00			TRANSISTOR: SILICON, FET, DUAL	17856	DN399
Q220 ^{1,3}	153-0596-00	B010100	B079999	SEMICONV DVC SE: SILICON, NPN, 2N3563	80009	153-0596-00
Q220 ^{1,3}	153-0631-00	B080000		SEMICONV DVC SE: SILICON, NPN	80009	153-0631-00
Q220 ^{2,3}	153-0596-00	B020100	B059999	SEMICONV DVC SE: SILICON, NPN, 2N3563	80009	153-0596-00
Q220 ^{2,3}	153-0631-00	B060000		SEMICONV DVC SE: SILICON, NPN	80009	153-0631-00
Q225	151-0225-00			TRANSISTOR: SILICON, NPN	07910	CS23365
Q240 ⁴	153-0597-00			SEMICONV DVC SE: SILICON, PNP	80009	153-0597-00
Q250 ¹	151-0221-00	B010100	B079999	TRANSISTOR: SILICON, PNP	80009	151-0221-00
Q250 ^{1,5}	153-0597-00	B080000		SEMICONV DVC SE: SILICON, PNP	80009	153-0597-00
Q250 ²	151-0221-00	B020100	B059999	TRANSISTOR: SILICON, PNP	80009	151-0221-00
Q250 ^{2,5}	153-0597-00	B060000		SEMICONV DVC SE: SILICON, PNP	80009	153-0597-00
Q260 ¹	151-0225-00	B010100	B039999	TRANSISTOR: SILICON, NPN	07910	CS23365
Q260 ¹	151-0367-00	B040000	B079999	TRANSISTOR: SILICON, NPN, SEL FROM 3571TP	80009	151-0367-00
Q260 ¹	151-0441-00	B080000		TRANSISTOR: SILICON, NPN	80009	151-0441-00
Q260 ²	151-0225-00	B020100	B029999	TRANSISTOR: SILICON, NPN	07910	CS23365
Q260 ²	151-0367-00	B030000	B059999	TRANSISTOR: SILICON, NPN, SEL FROM 3571TP	80009	151-0367-00
Q260 ²	151-0441-00	B060000		TRANSISTOR: SILICON, NPN	80009	151-0441-00

¹7A18 only.

²7A18N only.

³Q220 and Q320 furnished as a matched pair.

⁴Q240 and Q340 furnished as a matched pair.

⁵Q250 and Q350 furnished as a matched pair.

Electrical Parts List—7A18/7A18N

Ckt No.	Tektronix Part No.	Serial/Model No. Eff	Dscont	Name & Description	Mfr Code	Mfr Part Number
Q280	151-0221-00			TRANSISTOR:SILICON,PNP	80009	151-0221-00
Q320 ^{1,2}	153-0596-00	B010100	B079999	SEMICON DVC SE:SILICON,NPN,2N3563	80009	153-0596-00
Q320 ^{1,2}	153-0631-00	B080000		SEMICON DVC SE:SILICON,NPN	80009	153-0631-00
Q320 ^{2,3}	153-0596-00	B020100	B059999	SEMICON DVC SE:SILICON,NPN,2N3563	80009	153-0596-00
Q320 ^{2,3}	153-0631-00	B060000		SEMICON DVC SE:SILICON,NPN	80009	153-0631-00
Q325	151-0225-00			TRANSISTOR:SILICON,NPN	07910	CS23365
Q340 ⁴	153-0597-00			SEMICON DVC SE:SILICON,PNP	80009	153-0597-00
Q350 ¹	151-0221-00	B010100	B079999	TRANSISTOR:SILICON,PNP	80009	151-0221-00
Q350 ^{1,5}	153-0597-00	B080000		SEMICON DVC SE:SILICON,PNP	80009	153-0597-00
Q350 ³	151-0221-00	B020100	B059999	TRANSISTOR:SILICON,PNP	80009	151-0221-00
Q350 ^{3,5}	153-0597-00	B060000		SEMICON DVC SE:SILICON,PNP	80009	153-0597-00
Q360 ¹	151-0225-00	B010100	B039999	TRANSISTOR:SILICON,NPN	07910	CS23365
Q360 ¹	151-0367-00	B040000	B079999	TRANSISTOR:SILICON,NPN,SEL FROM 3571TP	80009	151-0367-00
Q360 ¹	151-0441-00	B080000		TRANSISTOR:SILICON,NPN	80009	151-0441-00
Q360 ³	151-0225-00	B020100	B029999	TRANSISTOR:SILICON,NPN	07910	CS23365
Q360 ³	151-0367-00	B030000	B059999	TRANSISTOR:SILICON,NPN,SEL FROM 3571TP	80009	151-0367-00
Q360 ³	151-0441-00	B060000		TRANSISTOR:SILICON,NPN	80009	151-0441-00
Q380	151-0221-00			TRANSISTOR:SILICON,PNP	80009	151-0221-00
Q410A,B	151-1032-00			TRANSISTOR:SILICON,FET,DUAL	17856	DN399
Q420 ^{1,6}	153-0596-00	B010100	B079999	SEMICON DVC SE:SILICON,NPN,2N3563	80009	153-0596-00
Q420 ^{1,6}	153-0631-00	B080000		SEMICON DVC SE:SILICON,NPN	80009	153-0631-00
Q420 ^{3,6}	153-0596-00	B020100	B059999	SEMICON DVC SE:SILICON,NPN,2N3563	80009	153-0596-00
Q420 ^{3,6}	153-0631-00	B060000		SEMICON DVC SE:SILICON,NPN	80009	153-0631-00
Q425 ⁷	153-0595-00			SEMICON DVC SE:SILICON,NPN,2N3563	80009	153-0595-00
Q426 ⁷	153-0595-00			SEMICON DVC SE:SILICON,NPN,2N3563	80009	153-0595-00
Q440 ⁸	153-0597-00			SEMICON DVC SE:SILICON,PNP	80009	153-0597-00
Q450 ¹	151-0221-00	B010100	B079999	TRANSISTOR:SILICON,PNP	80009	151-0221-00
Q450 ^{1,9}	153-0597-00	B080000		SEMICON DVC SE:SILICON,PNP	80009	153-0597-00
Q450 ³	151-0221-00	B020100	B059999	TRANSISTOR:SILICON,PNP	80009	151-0221-00
Q450 ^{3,9}	153-0597-00	B060000		SEMICON DVC SE:SILICON,PNP	80009	153-0597-00
Q460 ¹	151-0225-00	B010100	B039999	TRANSISTOR:SILICON,NPN	07910	CS23365
Q460 ¹	151-0367-00	B040000	B079999	TRANSISTOR:SILICON,NPN,SEL FROM 3571TP	80009	151-0367-00
Q460 ¹	151-0441-00	B080000		TRANSISTOR:SILICON,NPN	80009	151-0441-00
Q460 ³	151-0225-00	B020100	B029999	TRANSISTOR:SILICON,NPN	07910	CS23365
Q460 ³	151-0367-00	B030000	B059999	TRANSISTOR:SILICON,NPN,SEL FROM 3571TP	80009	151-0367-00
Q460 ³	151-0441-00	B060000		TRANSISTOR:SILICON,NPN	80009	151-0441-00
Q480	151-0221-00			TRANSISTOR:SILICON,PNP	80009	151-0221-00
Q520 ^{1,6}	153-0596-00	B010100	B079999	SEMICON DVC SE:SILICON,NPN,2N3563	80009	153-0596-00
Q520 ^{1,6}	153-0631-00	B080000		SEMICON DVC SE:SILICON,NPN	80009	153-0631-00
Q520 ^{3,6}	153-0596-00	B020100	B059999	SEMICON DVC SE:SILICON,NPN,2N3563	80009	153-0596-00
Q520 ^{3,6}	153-0631-00	B060000		SEMICON DVC SE:SILICON,NPN	80009	153-0631-00
Q525 ⁷	153-0595-00			SEMICON DVC SE:SILICON,NPN,2N3563	80009	153-0595-00
Q526 ⁷	153-0595-00			SEMICON DVC SE:SILICON,NPN,2N3563	80009	153-0595-00
Q540 ⁸	153-0597-00			SEMICON DVC SE:SILICON,PNP	80009	153-0597-00
Q550 ¹	151-0221-00	B010100	B079999	TRANSISTOR:SILICON,PNP	80009	151-0221-00
Q550 ^{1,9}	153-0597-00	B080000		SEMICON DVC SE:SILICON,PNP	80009	153-0597-00
Q550 ³	151-0221-00	B020100	B059999	TRANSISTOR:SILICON,PNP	80009	151-0221-00
Q550 ^{3,9}	153-0597-00	B060000		SEMICON DVC SE:SILICON,PNP	80009	153-0597-00
Q560 ¹	151-0225-00	B010100	B039999	TRANSISTOR:SILICON,NPN	07910	CS23365
Q560 ¹	151-0367-00	B040000	B079999	TRANSISTOR:SILICON,NPN,SEL FROM 3571TP	80009	151-0367-00
Q560 ¹	151-0441-00	B080000		TRANSISTOR:SILICON,NPN	80009	151-0441-00
Q560 ³	151-0225-00	B020100	B029999	TRANSISTOR:SILICON,NPN	07910	CS23365
Q560 ³	151-0367-00	B030000	B059999	TRANSISTOR:SILICON,NPN,SEL FROM 3571TP	80009	151-0367-00

¹7A18 only.

²Q220 and Q320 furnished as a matched pair.

³7A18N only.

⁴Q240 and Q340 furnished as a matched pair.

⁵Q250 and Q350 furnished as a mtached pair.

⁶Q420 and Q520 furnished as a matched pair.

⁷Q425, Q426, Q525 and Q526 furnished as a matched set.

⁸Q440 and Q540 furnished as a matched pair.

⁹Q450 and Q550 furnished as a matched pair.

Ckt No.	Tektronix Part No.	Serial/Model No.		Name & Description	Mfr	
		Eff	Dscont		Code	Mfr Part Number
Q560 ¹	151-0441-00	B060000		TRANSISTOR:SILICON,NPN	80009	151-0441-00
Q580	151-0221-00			TRANSISTOR:SILICON,PNP	80009	151-0221-00
R32	315-0123-00			RES.,FXD,CMPSN:12K OHM,5%,0.25W	01121	CB1235
R210	316-0474-00			RES.,FXD,CMPSN:470K OHM,10%,0.25W	01121	CB4741
R211	315-0470-00			RES.,FXD,CMPSN:47 OHM,5%,0.25W	01121	CB4705
R212	315-0561-00			RES.,FXD,CMPSN:560 OHM,5%,0.25W	01121	CB5615
R215	315-0391-00			RES.,FXD,CMPSN:390 OHM,5%,0.25W	01121	CB3915
R222	321-0153-00			RES.,FXD,FILM:383 OHM,1%,0.125W	75042	CEATO-3830F
R223	323-0257-00			RES.,FXD,FILM:4.64K OHM,0.5%,0.5W	75042	CECTO-4641F
R224	321-0032-00			RES.,FXD,FILM:21 OHM,1%,0.125W	75042	CEATO-21R00F
R225 ²	315-0471-00	B010100	B079999	RES.,FXD,CMPSN:470 OHM,5%,0.25W	01121	CB4715
R225 ²	315-0621-00	B080000		RES.,FXD,CMPSN:620 OHM,5%,0.25W	01121	CB6215
R225 ¹	315-0471-00	B020100	B059999	RES.,FXD,CMPSN:470 OHM,5%,0.25W	01121	CB4715
R225 ¹	315-0621-00	B060000		RES.,FXD,CMPSN:620 OHM,5%,0.25W	01121	CB6215
R226	321-0122-00			RES.,FXD,FILM:182 OHM,1%,0.125W	75042	CEATO-1820F
R227 ²	315-0821-00	B010100	B079999	RES.,FXD,CMPSN:820 OHM,5%,0.25W	01121	CB8215
R227 ²	315-0561-00	B080000		RES.,FXD,CMPSN:560 OHM,5%,0.25W	01121	CB5615
R227 ¹	315-0821-00	B020100	B059999	RES.,FXD,CMPSN:820 OHM,5%,0.25W	01121	CB8215
R227 ¹	315-0561-00	B060000		RES.,FXD,CMPSN:560 OHM,5%,0.25W	01121	CB5615
R241 ²	315-0241-00	B010100	B079999	RES.,FXD,CMPSN:240 OHM,5%,0.25W	01121	CB2415
R241 ²	315-0221-00	B080000		RES.,FXD,CMPSN:220 OHM,5%,0.25W	01121	CB2215
R241 ¹	315-0241-00	B020100	B059999	RES.,FXD,CMPSN:240 OHM,5%,0.25W	01121	CB2415
R241 ¹	315-0221-00	B060000		RES.,FXD,CMPSN:220 OHM,5%,0.25W	01121	CB2215
R242 ²	321-0068-00	XB080000		RES.,FXD,FILM:49.9 OHM,1%,0.125W	75042	CEATO-49R90F
R242 ¹	321-0068-00	XB060000		RES.,FXD,FILM:49.9 OHM,1%,0.125W	75042	CEATO-49R90F
R243	323-0255-00			RES.,FXD,FILM:4.42K OHM,1%,0.50W	75042	CECTO-4421F
R244	321-0126-00			RES.,FXD,FILM:200 OHM,1%,0.125W	75042	CEATO-2000F
R245	311-0634-00			RES.,VAR,NONWIR:500 OHM,10%,0.50W	80740	62-55-3
R246 ²	315-0103-00	B010100	B079999	RES.,FXD,CMPSN:10K OHM,5%,0.25W	01121	CB1035
R246 ²	315-0912-00	B080000		RES.,FXD,CMPSN:9.1K OHM,5%,0.25W	01121	CB9125
R246 ¹	315-0103-00	B020100	B059999	RES.,FXD,CMPSN:10K OHM,5%,0.25W	01121	CB1035
R246 ¹	315-0912-00	B060000		RES.,FXD,CMPSN:9.1K OHM,5%,0.25W	01121	CB9125
R250	321-0105-00			RES.,FXD,FILM:121 OHM,1%,0.125W	75042	CEATO-1210F
R251	321-0137-00			RES.,FXD,FILM:261 OHM,1%,0.125W	75042	CEATO-2610F
R256	315-0471-00			RES.,FXD,CMPSN:470 OHM,5%,0.25W	01121	CB4715
R257	315-0153-00			RES.,FXD,CMPSN:15K OHM,5%,0.25W	01121	CB1535
R259	315-0103-00			RES.,FXD,CMPSN:10K OHM,5%,0.25W	01121	CB1035
R260	315-0101-00			RES.,FXD,CMPSN:100 OHM,5%,0.25W	01121	CB1015
R263	315-0272-00			RES.,FXD,CMPSN:2.7K OHM,5%,0.25W	01121	CB2725
R264	315-0330-00			RES.,FXD,CMPSN:33 OHM,5%,0.25W	01121	CB3305
R274 ²	315-0182-00	B010100	B079999	RES.,FXD,CMPSN:1.8K OHM,5%,0.25W	01121	CB1825
R274 ²	315-0392-00	B080000		RES.,FXD,CMPSN:3.9K OHM,5%,0.25W	01121	CB3925
R274 ¹	315-0182-00	B010200	B059999	RES.,FXD,CMPSN:1.8K OHM,5%,0.25W	01121	CB1825
R274 ¹	315-0392-00	B060000		RES.,FXD,CMPSN:3.9K OHM,5%,0.25W	01121	CB3925
R275	315-0100-00			RES.,FXD,CMPSN:10 OHM,5%,0.25W	01121	CB1005
R276	321-0059-00			RES.,FXD,FILM:40.2 OHM,1%,0.125W	75042	CEATO-40R20F
R277	321-0059-00			RES.,FXD,FILM:40.2 OHM,1%,0.125W	75042	CEATO-40R20F
R278	323-0189-00			RES.,FXD,FILM:909 OHM,1%,0.50W	75042	CECTO-9090F
R280	315-0330-00			RES.,FXD,CMPSN:33 OHM,5%,0.25W	01121	CB3305
R282	323-0150-00			RES.,FXD,FILM:357 OHM,1%,0.5W	75042	CECTO-3570F

¹7A18N only.
²7A18 only.

Electrical Parts List—7A18/7A18N

Ckt No.	Tektronix		Serial/Model No.		Name & Description	Mfr	
	Part No.	Eff	Dscont	Code		Mfr Part Number	
R284 ¹	316-0121-00	B010100	B039999X	RES., FXD, CMPSN:120	OHM, 10%, 0.25W	01121	CB1211
R284 ²	316-0121-00	B020100	B029999X	RES., FXD, CMPSN:120	OHM, 10%, 0.25W	01121	CB1211
R286	323-0206-00			RES., FXD, FILM:1.37K	OHM, 1%, 0.50W	75042	CECT0-1371F
R313	315-0105-00			RES., FXD, CMPSN:1M	OHM, 5%, 0.25W	01121	CB1055
R317	321-0032-00			RES., FXD, FILM:21	OHM, 1%, 0.125W	75042	CEAT0-21ROOF
R318	315-0911-00			RES., FXD, CMPSN:910	OHM, 5%, 0.25W	01121	CB9115
R319	315-0391-00			RES., FXD, CMPSN:390	OHM, 5%, 0.25W	01121	CB3915
R321	311-0633-00			RES., VAR, NONWIR:5K	OHM, 10%, 0.50W	80740	62-58-3
R322 ¹	315-0123-00	B010100	B079999	RES., FXD, CMPSN:12K	OHM, 5%, 0.25W	01121	CB1235
R322 ¹	315-0273-00	B080000		RES., FXD, CMPSN:27K	OHM, 5%, 0.25W	01121	CB2735
R322 ²	315-0123-00	B020100	B059999	RES., FXD, CMPSN:12K	OHM, 5%, 0.25W	01121	CB1235
R322 ²	315-0273-00	B060000		RES., FXD, CMPSN:27K	OHM, 5%, 0.25W	01121	CB2735
R323 ¹	315-0131-00	B010100	B079999	RES., FXD, CMPSN:130	OHM, 5%, 0.25W	01121	CB1315
R323 ¹	315-0271-00	B080000		RES., FXD, CMPSN:270	OHM, 5%, 0.25W	01121	CB2715
R323 ²	315-0131-00	B020000	B059999	RES., FXD, CMPSN:130	OHM, 5%, 0.25W	01121	CB1315
R323 ²	315-0271-00	B060000		RES., FXD, CMPSN:270	OHM, 5%, 0.25W	01121	CB2715
R324	321-0032-00			RES., FXD, FILM:21	OHM, 1%, 0.125W	75042	CEAT0-21ROOF
R325 ¹	315-0471-00	B010100	B079999	RES., FXD, CMPSN:470	OHM, 5%, 0.25W	01121	CB4715
R325 ¹	315-0621-00	B080000		RES., FXD, CMPSN:620	OHM, 5%, 0.25W	01121	CB6215
R325 ²	315-0471-00	B020100	B059999	RES., FXD, CMPSN:470	OHM, 5%, 0.25W	01121	CB4715
R325 ²	315-0621-00	B060000		RES., FXD, CMPSN:620	OHM, 5%, 0.25W	01121	CB6215
R326	321-0122-00			RES., FXD, FILM:182	OHM, 1%, 0.125W	75042	CEAT0-1820F
R327 ¹	315-0361-00	B010100	B079999	RES., FXD, CMPSN:360	OHM, 5%, 0.25W	01121	CB3615
R327 ¹	315-0431-00	B080000		RES., FXD, CMPSN:430	OHM, 5%, 0.25W	01121	CB4315
R327 ²	315-0361-00	B020100	B059999	RES., FXD, CMPSN:360	OHM, 5%, 0.25W	01121	CB3615
R327 ²	315-0431-00	B060000		RES., FXD, CMPSN:430	OHM, 5%, 0.25W	01121	CB4315
R341 ¹	315-0241-00	B010100	B079999	RES., FXD, CMPSN:240	OHM, 5%, 0.25W	01121	CB2415
R341 ¹	315-0221-00	B080000		RES., FXD, CMPSN:220	OHM, 5%, 0.25W	01121	CB2215
R341 ²	315-0241-00	B020100	B059999	RES., FXD, CMPSN:240	OHM, 5%, 0.25W	01121	CB2415
R341 ²	315-0221-00	B060000		RES., FXD, CMPSN:220	OHM, 5%, 0.25W	01121	CB2215
R342 ¹	321-0068-00	XB080000		RES., FXD, FILM:49.9	OHM, 1%, 0.125W	75042	CEAT0-49R90F
R342 ²	321-0068-00	XB060000		RES., FXD, FILM:49.9	OHM, 1%, 0.125W	75042	CEAT0-49R90F
R343	323-0255-00			RES., FXD, FILM:4.42K	OHM, 1%, 0.50W	75042	CECT0-4421F
R345 ¹	315-0392-00	B010100	B079999	RES., FXD, CMPSN:3.9K	OHM, 5%, 0.25W	01121	CB3925
R345 ¹	315-0623-00	B080000		RES., FXD, CMPSN:62K	OHM, 5%, 0.25W	01121	CB6235
R345 ²	315-0392-00	B020100	B059999	RES., FXD, CMPSN:3.9K	OHM, 5%, 0.25W	01121	CB3925
R345 ²	315-0623-00	B060000		RES., FXD, CMPSN:62K	OHM, 5%, 0.25W	01121	CB6235
R350	323-0153-00			RES., FXD, FILM:383	OHM, 1%, 0.50W	75042	CECT0-3830F
R351	321-0137-00			RES., FXD, FILM:261	OHM, 1%, 0.125W	75042	CEAT0-2610F
R356	315-0471-00			RES., FXD, CMPSN:470	OHM, 5%, 0.25W	01121	CB4715
R357	315-0274-00			RES., FXD, CMPSN:270K	OHM, 5%, 0.25W	01121	CB2745
R358 ³	315-0222-00			RES., FXD, CMPSN:2.2K	OHM, 5%, 0.25W	01121	CB2225
R359	315-0122-00			RES., FXD, CMPSN:1.2K	OHM, 5%, 0.25W	01121	CB1225
R363	315-0272-00			RES., FXD, CMPSN:2.7K	OHM, 5%, 0.25W	01121	CB2725
R364	315-0330-00			RES., FXD, CMPSN:33	OHM, 5%, 0.25W	01121	CB3305
R370	321-0217-00			RES., FXD, FILM:1.78K	OHM, 1%, 0.125W	75042	CEAT0-1781F
R374 ¹	315-0182-00	B010100	B079999	RES., FXD, CMPSN:1.8K	OHM, 5%, 0.25W	01121	CB1825
R374 ¹	315-0392-00	B080000		RES., FXD, CMPSN:3.9K	OHM, 5%, 0.25W	01121	CB3925
R374 ²	315-0182-00	B020100	B059999	RES., FXD, CMPSN:1.8K	OHM, 5%, 0.25W	01121	CB1825
R374 ²	315-0392-00	B060000		RES., FXD, CMPSN:3.9K	OHM, 5%, 0.25W	01121	CB3925
R375	315-0100-00			RES., FXD, CMPSN:10	OHM, 5%, 0.25W	01121	CB1005
R376	321-0059-00			RES., FXD, FILM:40.2	OHM, 1%, 0.125W	75042	CEAT0-40R20F
R377	321-0059-00			RES., FXD, FILM:40.2	OHM, 1%, 0.125W	75042	CEAT0-40R20F

¹7A18 only.

²7A18N only.

³7A18 option 1 only.

Ckt No.	Tektronix Part No.	Serial/Model No. Eff	Dscont	Name & Description	Mfr Code	Mfr Part Number
R378	323-0189-00			RES., FXD, FILM: 909 OHM, 1%, 0.50W	75042	CECTO-9090F
R380	315-0330-00			RES., FXD, CMPSN: 33 OHM, 5%, 0.25W	01121	CB3305
R382	323-0150-00			RES., FXD, FILM: 357 OHM, 1%, 0.5W	75042	CECTO-3570F
R384 ¹	316-0121-00	B010100	B039999	RES., FXD, CMPSN: 120 OHM, 10%, 0.25W	01121	CB1211
R384 ¹	315-0271-00	B040000		RES., FXD, CMPSN: 270 OHM, 5%, 0.25W	01121	CB2715
R384 ²	316-0121-00	B020100	B029999	RES., FXD, CMPSN: 120 OHM, 10%, 0.25W	01121	CB1211
R384 ²	315-0271-00	B030000		RES., FXD, CMPSN: 270 OHM, 5%, 0.25W	01121	CB2715
R386	323-0206-00			RES., FXD, FILM: 1.37K OHM, 1%, 0.50W	75042	CECTO-1371F
R390	315-0470-00			RES., FXD, CMPSN: 47 OHM, 5%, 0.25W	01121	CB4705
R400	315-0152-00			RES., FXD, CMPSN: 1.5K OHM, 5%, 0.25W	01121	CB1525
R401	315-0101-00			RES., FXD, CMPSN: 100 OHM, 5%, 0.25W	01121	CB1015
R410	316-0474-00			RES., FXD, CMPSN: 470K OHM, 10%, 0.25W	01121	CB4741
R411	315-0470-00			RES., FXD, CMPSN: 47 OHM, 5%, 0.25W	01121	CB4705
R412	315-0561-00			RES., FXD, CMPSN: 560 OHM, 5%, 0.25W	01121	CB5615
R415	315-0391-00			RES., FXD, CMPSN: 390 OHM, 5%, 0.25W	01121	CB3915
R416	315-0911-00			RES., FXD, CMPSN: 910 OHM, 5%, 0.25W	01121	CB9115
R418	321-0032-00			RES., FXD, FILM: 21 OHM, 1%, 0.125W	75042	CEATO-21R00F
R422	321-0153-00			RES., FXD, FILM: 383 OHM, 1%, 0.125W	75042	CEATO-3830F
R423	323-0257-00			RES., FXD, FILM: 4.64K OHM, 1%, 0.5W	75042	CECTO-4641F
R424	321-0032-00			RES., FXD, FILM: 21 OHM, 1%, 0.125W	75042	CEATO-21R00F
R425 ¹	315-0471-00	B010100	B079999	RES., FXD, CMPSN: 470 OHM, 5%, 0.25W	01121	CB4715
R425 ¹	315-0621-00	B080000		RES., FXD, CMPSN: 620 OHM, 5%, 0.25W	01121	CB6215
R425 ²	315-0471-00	B020100	B059999	RES., FXD, CMPSN: 470 OHM, 5%, 0.25W	01121	CB4715
R425 ²	315-0621-00	B060000		RES., FXD, CMPSN: 620 OHM, 5%, 0.25W	01121	CB6215
R426	321-0122-00			RES., FXD, FILM: 182 OHM, 1%, 0.125W	75042	CEATO-1820F
R427 ¹	315-0821-00	B010100	B079999	RES., FXD, CMPSN: 820 OHM, 5%, 0.25W	01121	CB8215
R427 ¹	315-0561-00	B080000		RES., FXD, CMPSN: 560 OHM, 5%, 0.25W	01121	CB5615
R427 ²	315-0821-00	B020100	B059999	RES., FXD, CMPSN: 820 OHM, 5%, 0.25W	01121	CB8215
R427 ²	315-0561-00	B060000		RES., FXD, CMPSN: 560 OHM, 5%, 0.25W	01121	CB5615
R428 ¹	315-0241-00	B010100	B079999	RES., FXD, CMPSN: 240 OHM, 5%, 0.25W	01121	CB2415
R428 ¹	315-0301-00	B080000		RES., FXD, CMPSN: 300 OHM, 5%, 0.25W	01121	CB3015
R428 ²	315-0241-00	B020100	B059999	RES., FXD, CMPSN: 240 OHM, 5%, 0.25W	01121	CB2415
R428 ²	315-0301-00	B060000		RES., FXD, CMPSN: 300 OHM, 5%, 0.25W	01121	CB3015
R429 ¹	315-0821-00	B010100	B079999	RES., FXD, CMPSN: 820 OHM, 5%, 0.25W	01121	CB8215
R429 ¹	315-0561-00	B080000		RES., FXD, CMPSN: 560 OHM, 5%, 0.25W	01121	CB5615
R429 ²	315-0821-00	B020100	B059999	RES., FXD, CMPSN: 820 OHM, 5%, 0.25W	01121	CB8215
R429 ²	315-0561-00	B060000		RES., FXD, CMPSN: 560 OHM, 5%, 0.25W	01121	CB5615
R441 ¹	315-0241-00	B010100	B079999	RES., FXD, CMPSN: 240 OHM, 5%, 0.25W	01121	CB2415
R441 ¹	315-0221-00	B080000		RES., FXD, CMPSN: 220 OHM, 5%, 0.25W	01121	CB2215
R441 ²	315-0241-00	B020100	B059999	RES., FXD, CMPSN: 240 OHM, 5%, 0.25W	01121	CB2415
R441 ²	315-0221-00	B060000		RES., FXD, CMPSN: 220 OHM, 5%, 0.25W	01121	CB2215
R442 ¹	321-0068-00	XB080000		RES., FXD, FILM: 49.9 OHM, 1%, 0.125W	75042	CEATO-49R90F
R442 ²	321-0068-00	XB060000		RES., FXD, FILM: 49.9 OHM, 1%, 0.125W	75042	CEATO-49R90F
R443	323-0255-00			RES., FXD, FILM: 4.42K OHM, 1%, 0.50W	75042	CECTO-4421F
R444	321-0126-00			RES., FXD, FILM: 200 OHM, 1%, 0.125W	75042	CEATO-2000F
R445	311-0634-00			RES., VAR, NONWIR: 500 OHM, 10%, 0.50W	80740	62-55-3
R446 ¹	315-0392-00	B010100	B079999	RES., FXD, CMPSN: 3.9K OHM, 5%, 0.25W	01121	CB3925
R446 ¹	315-0623-00	B080000		RES., FXD, CMPSN: 62K OHM, 5%, 0.25W	01121	CB6235
R446 ²	315-0392-00	B020100	B059999	RES., FXD, CMPSN: 3.9K OHM, 5%, 0.25W	01121	CB3925
R446 ²	315-0623-00	B060000		RES., FXD, CMPSN: 62K OHM, 5%, 0.25W	01121	CB6235
R450	321-0110-00			RES., FXD, FILM: 137 OHM, 1%, 0.125W	75042	CEATO-1370F
R451	321-0137-00			RES., FXD, FILM: 261 OHM, 1%, 0.125W	75042	CEATO-2610F
R455	315-0272-00			RES., FXD, CMPSN: 2.7K OHM, 5%, 0.25W	01121	CB2725

¹7A18 only.
²7A18N only.

Electrical Parts List—7A18/7A18N

Ckt No.	Tektronix Part No.	Serial/Model No. Eff	Dscont	Name & Description	Mfr Code	Mfr Part Number
R456	315-0471-00			RES.,FXD,CMPSN:470 OHM,5%,0.25W	01121	CB4715
R459	315-0103-00			RES.,FXD,CMPSN:10K OHM,5%,0.25W	01121	CB1035
R460	315-0101-00			RES.,FXD,CMPSN:100 OHM,5%,0.25W	01121	CB1015
R463	315-0272-00			RES.,FXD,CMPSN:2.7K OHM,5%,0.25W	01121	CB2725
R464	315-0330-00			RES.,FXD,CMPSN:33 OHM,5%,0.25W	01121	CB3305
R474	315-0182-00			RES.,FXD,CMPSN:1.8K OHM,5%,0.25W	01121	CB1825
R475	315-0100-00			RES.,FXD,CMPSN:10 OHM,5%,0.25W	01121	CB1005
R476	321-0059-00			RES.,FXD,FILM:40.2 OHM,1%,0.125W	75042	CEATO-40R20F
R477	321-0059-00			RES.,FXD,FILM:40.2 OHM,1%,0.125W	75042	CEATO-40R20F
R478	323-0189-00			RES.,FXD,FILM:909 OHM,1%,0.50W	75042	CECTO-9090F
R480	315-0330-00			RES.,FXD,CMPSN:33 OHM,5%,0.25W	01121	CB3305
R482	323-0150-00			RES.,FXD,FILM:375 OHM,1%,0.5W	75042	CECTO-3570F
R484	315-0331-00			RES.,FXD,CMPSN:330 OHM,5%,0.25W	01121	CB3315
R486	323-0206-00			RES.,FXD,FILM:1.37K OHM,1%,0.50W	75042	CECTO-1371F
R513	315-0105-00			RES.,FXD,CMPSN:1M OHM,5%,0.25W	01121	CB1055
R517	321-0032-00			RES.,FXD,FILM:21 OHM,1%,0.125W	75042	CEATO-21R00F
R518	315-0911-00			RES.,FXD,CMPSN:910 OHM,5%,0.25W	01121	CB9115
R519	315-0391-00			RES.,FXD,CMPSN:390 OHM,5%,0.25W	01121	CB3915
R521	311-0633-00			RES.,VAR,NONWIR:5K OHM,10%,0.50W	80740	62-58-3
R522 ¹	315-0123-00	B010100	B079999	RES.,FXD,CMPSN:12K OHM,5%,0.25W	01121	CB1235
R522 ¹	315-0273-00	B080000		RES.,FXD,CMPSN:27K OHM,5%,0.25W	01121	CB2735
R522 ²	315-0123-00	B020100	B059999	RES.,FXD,CMPSN:12K OHM,5%,0.25W	01121	CB1235
R522 ²	315-0273-00	B060000		RES.,FXD,CMPSN:27K OHM,5%,0.25W	01121	CB2735
R523 ¹	315-0131-00	B010100	B079999	RES.,FXD,CMPSN:130 OHM,5%,0.25W	01121	CB1315
R523 ¹	315-0271-00	B080000		RES.,FXD,CMPSN:270 OHM,5%,0.25W	01121	CB2715
R523 ²	315-0131-00	B020100	B059999	RES.,FXD,CMPSN:130 OHM,5%,0.25W	01121	CB1315
R523 ²	315-0271-00	B060000		RES.,FXD,CMPSN:270 OHM,5%,0.25W	01121	CB2715
R524	321-0032-00			RES.,FXD,FILM:21 OHM,1%,0.125W	75042	CEATO-21R00F
R525 ¹	315-0471-00	B010100	B079999	RES.,FXD,CMPSN:470 OHM,5%,0.25W	01121	CB4715
R525 ¹	315-0621-00	B080000		RES.,FXD,CMPSN:620 OHM,5%,0.25W	01121	CB6215
R525 ²	315-0471-00	B020100	B059999	RES.,FXD,CMPSN:470 OHM,5%,0.25W	01121	CB4715
R525 ²	315-0621-00	B060000		RES.,FXD,CMPSN:620 OHM,5%,0.25W	01121	CB6215
R526	321-0122-00			RES.,FXD,FILM:182 OHM,1%,0.125W	75042	CEATO-1820F
R527 ¹	315-0621-00	B010100	B079999	RES.,FXD,CMPSN:620 OHM,5%,0.25W	01121	CB6215
R527 ¹	315-0751-00	B080000		RES.,FXD,CMPSN:750 OHM,5%,0.25W	01121	CB7515
R527 ²	315-0621-00	B020100	B059999	RES.,FXD,CMPSN:620 OHM,5%,0.25W	01121	CB6215
R527 ²	315-0751-00	B060000		RES.,FXD,CMPSN:750 OHM,5%,0.25W	01121	CB7515
R529 ¹	315-0621-00	B010100	B079999	RES.,FXD,CMPSN:620 OHM,5%,0.25W	01121	CB6215
R529 ¹	315-0751-00	B080000		RES.,FXD,CMPSN:750 OHM,5%,0.25W	01121	CB7515
R529 ²	315-0621-00	B020100	B059999	RES.,FXD,CMPSN:620 OHM,5%,0.25W	01121	CB6215
R529 ²	315-0751-00	B060000		RES.,FXD,CMPSN:750 OHM,5%,0.25W	01121	CB7515
R541 ¹	315-0241-00	B010100	B079999	RES.,FXD,CMPSN:240 OHM,5%,0.25W	01121	CB2415
R541 ¹	315-0221-00	B060000		RES.,FXD,CMPSN:220 OHM,5%,0.25W	01121	CB2215
R541 ²	315-0241-00	B020100	B059999	RES.,FXD,CMPSN:240 OHM,5%,0.25W	01121	CB2415
R541 ²	315-0221-00	B060000		RES.,FXD,CMPSN:220 OHM,5%,0.25W	01121	CB2215
R542 ¹	321-0068-00	XB080000	B089999	RES.,FXD,FILM:49.9 OHM,1%,0.125W	75042	CEATO-49R90F
R542 ¹	321-0071-00	B090000		RES.,FXD,FILM:53.6 OHM,1%,0.125W	75042	CEATO-53R6F
R542 ²	321-0068-00	XB060000	B069999	RES.,FXD,FILM:49.9 OHM,1%,0.125W	75042	CEATO-49R90F
R542 ²	321-0071-00	B070000		RES.,FXD,FILM:53.6 OHM,1%,0.125W	75042	CEATO-53R6F
R543	323-0255-00			RES.,FXD,FILM:4.42K OHM,1%,0.50W	75042	CECTO-4421F
R544 ¹	311-0609-00	XB090000		RES.,VAR,NONWIR:2K OHM,10%,0.50W	80740	62-57-3
R544 ²	311-0609-00	XB070000		RES.,VAR,NONWIR:2K OHM,10%,0.50W	80740	62-57-3
R545 ¹	315-0103-00	B010100	B079999	RES.,FXD,CMPSN:10K OHM,5%,0.25W	01121	CB1035

¹7A18 only.
²7A18N only.

Ckt No.	Tektronix Part No.	Serial/Model No. Eff Dscont	Name & Description	Mfr Code	Mfr Part Number
R545 ¹	315-0912-00	B080000	RES.,FXD,CMPSN:9.1K OHM,5%,0.25W	01121	CB9125
R545 ²	315-0103-00	B020100 B059999	RES.,FXD,CMPSN:10K OHM,5%,0.25W	01121	CB1035
R545 ²	315-0912-00	B060000	RES.,FXD,CMPSN:9.1K OHM,5%,0.25W	01121	CB9125
R550	323-0153-00		RES.,FXD,FILM:383 OHM,1%,0.50W	75042	CECTO-3830F
R551	321-0137-00		RES.,FXD,FILM:261 OHM,1%,0.125W	75042	CEATO-2610F
R555	315-0272-00		RES.,FXD,CMPSN:2.7K OHM,5%,0.25W	01121	CB2725
R556	315-0471-00		RES.,FXD,CMPSN:470 OHM,5%,0.25W	01121	CB4715
R557	315-0274-00		RES.,FXD,CMPSN:270K OHM,5%,0.25W	01121	CB2745
R558 ³	315-0222-00		RES.,FXD,CMPSN:2.2K OHM,5%,0.25W	01121	CB2225
R559	315-0122-00		RES.,FXD,CMPSN:1.2K OHM,5%,0.25W	01121	CB1225
R563	315-0272-00		RES.,FXD,CMPSN:2.7K OHM,5%,0.25W	01121	CB2725
R564	315-0330-00		RES.,FXD,CMPSN:33 OHM,5%,0.25W	01121	CB3305
R570	321-0217-00		RES.,FXD,FILM:1.78K OHM,1%,0.125W	75042	CEATO-1781F
R574	315-0182-00		RES.,FXD,CMPSN:1.8K OHM,5%,0.25W	01121	CB1825
R575	315-0100-00		RES.,FXD,CMPSN:10 OHM,5%,0.25W	01121	CB1005
R576	321-0059-00		RES.,FXD,FILM:40.2 OHM,1%,0.125W	75042	CEATO-40R20F
R577	321-0059-00		RES.,FXD,FILM:40.2 OHM,1%,0.125W	75042	CEATO-40R20F
R578	323-0189-00		RES.,FXD,FILM:909 OHM,1%,0.50W	75042	CECTO-9090F
R580	315-0330-00		RES.,FXD,CMPSN:33 OHM,5%,0.25W	01121	CB3305
R582	323-0150-00		RES.,FXD,FILM:357 OHM,1%,0.5W	75042	CECTO-3570F
R584	315-0331-00		RES.,FXD,CMPSN:330 OHM,5%,0.25W	01121	CB3315
R586	323-0206-00		RES.,FXD,FILM:1.37K OHM,1%,0.50W	75042	CECTO-1371F
R590	315-0470-00		RES.,FXD,CMPSN:47 OHM,5%,0.25W	01121	CB4705
U270	155-0022-00		MICROCIRCUIT,DI:A AND B LOGIC ML CHAN SW	80009	155-0022-00
U470	155-0022-00		MICROCIRCUIT,DI:A AND B LOGIC ML CHAN SW	80009	155-0022-00
A3 ⁴	670-1385-00	B010100 B099999	CKT BOARD ASSY:READOUT	80009	670-1385-00
A3 ⁴	670-1385-02	B100000	CKT BOARD ASSY:READOUT	80009	670-1385-02
C621	283-0000-00		CAP.,FXD,CER DI:0.001UF,+100-0%,500V	72982	831-516E102P
C630	283-0000-00		CAP.,FXD,CER DI:0.001UF,+100-0%,500V	72982	831-516E102P
C631	283-0000-00		CAP.,FXD,CER DI:0.001UF,+100-0%,500V	72982	831-516E102P
C634	283-0000-00		CAP.,FXD,CER DI:0.001UF,+100-0%,500V	72982	831-516E102P
C635	283-0000-00		CAP.,FXD,CER DI:0.001UF,+100-0%,500V	72982	831-516E102P
C638	283-0000-00		CAP.,FXD,CER DI:0.001UF,+100-0%,500V	72982	831-516E102P
C639	283-0000-00		CAP.,FXD,CER DI:0.001UF,+100-0%,500V	72982	831-516E102P
C641	283-0000-00		CAP.,FXD,CER DI:0.001UF,+100-0%,500V	72982	831-516E102P
C643	283-0000-00		CAP.,FXD,CER DI:0.001UF,+100-0%,500V	72982	831-516E102P
C647	283-0000-00		CAP.,FXD,CER DI:0.001UF,+100-0%,500V	72982	831-516E102P
C648	283-0003-00		CAP.,FXD,CER DI:0.01UF,+80-20%,150V	72982	855-547E103Z
C649	283-0000-00		CAP.,FXD,CER DI:0.001UF,+100-0%,500V	72982	831-516E102P
CR621	152-0185-00		SEMICONV DEVICE:SILICON,40PIV,150MA	07910	1N4152
CR647	152-0185-00		SEMICONV DEVICE:SILICON,40PIV,150MA	07910	1N4152
Q620	151-0254-00		TRANSISTOR:SILICON,NPN	03508	2N5308
R621	321-0223-00		RES.,FXD,FILM:2.05K OHM,1%,0.125W	75042	CEATO-2051F
R622	321-0269-00	B010100 B039999	RES.,FXD,FILM:6.19K OHM,1%,0.125W	75042	CEATO-6191F
R622	321-0299-00	B040000	RES.,FXD,FILM:12.7K OHM,1%,0.125W	75042	CEATO-1272F
R630	315-0154-00		RES.,FXD,CMPSN:150K OHM,5%,0.25W	01121	CB1545
R631	315-0753-00		RES.,FXD,CMPSN:75K OHM,5%,0.25W	01121	CB7535

¹7A18 only.

²7A18N only.

³7A18 option 1 only.

⁴7A18 only, included with 672-0020-02 Attenuator Circuit Board Assembly.

Electrical Parts List—7A18/7A18N

Ckt No.	Tektronix Part No.	Serial/Model No.		Name & Description	Mfr	
		Eff	Dscont		Code	Mfr Part Number
R633	315-0753-00			RES.,FXD,CMPSN:75K OHM,5%,0.25W	01121	CB7535
R634	315-0154-00			RES.,FXD,CMPSN:150K OHM,5%,0.25W	01121	CB1545
R635	321-0344-00			RES.,FXD,FILM:37.4K OHM,1%,0.125W	75042	CEATO-3742F
R637	315-0154-00			RES.,FXD,CMPSN:150K OHM,5%,0.25W	01121	CB1545
R638	315-0154-00			RES.,FXD,CMPSN:150K OHM,5%,0.25W	01121	CB1545
R639	315-0753-00			RES.,FXD,CMPSN:75K OHM,5%,0.25W	01121	CB7535
R640	315-0753-00			RES.,FXD,CMPSN:75K OHM,5%,0.25W	01121	CB7535
R641	315-0154-00			RES.,FXD,CMPSN:150K OHM,5%,0.25W	01121	CB1545
R642	315-0513-00			RES.,FXD,CMPSN:51K OHM,5%,0.25W	01121	CB5135
R643	321-0344-00			RES.,FXD,FILM:37.4K OHM,1%,0.125W	75042	CEATO-3742F
R645	315-0154-00			RES.,FXD,CMPSN:150K OHM,5%,0.25W	01121	CB1545
R646	315-0154-00			RES.,FXD,CMPSN:150K OHM,5%,0.25W	01121	CB1545
R647	315-0133-00			RES.,FXD,CMPSN:13K OHM,5%,0.25W	01121	CB1335
R648	315-0154-00			RES.,FXD,CMPSN:150K OHM,5%,0.25W	01121	CB1545

OPTION INFORMATION

Your instrument may be equipped with one or more options. This section describes those options, or directs the reader to where the option is documented.

	Pages
Option 6 DC OFFSET: Described in this section.	4

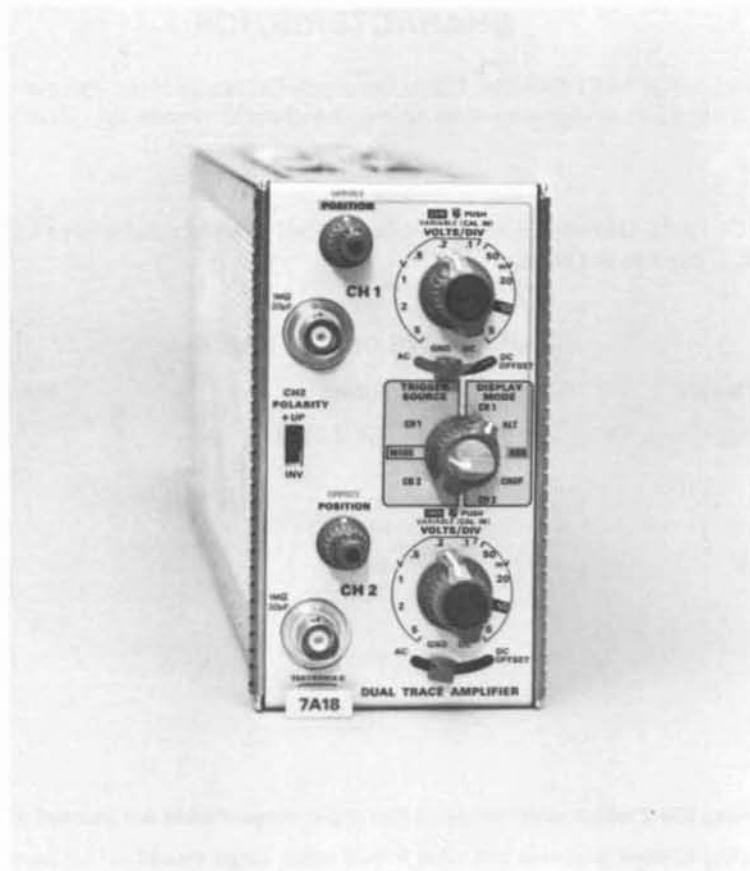

Fig. A. 7A18 OPTION 6.

The 7A18 with Option 6 is equipped with added DC offset circuits that provide up to ± 200 divisions of baseline offset within the input dynamic range, with uncalibrated front panel variable controls for each channel.

DC OFFSET. The internal DC Balance circuits have been modified to provide up to ± 1 V DC offset directly to the input of each amplifier, which gives up to ± 200 divisions of baseline offset range for all VOLTS/DIV settings.

CONTROLS. Separate CH 1 and CH 2 (uncalibrated) Variable Offset controls are added to the front panel. Each input coupling selector switch has an additional position for the DC offset function.

The variable controls are concentric with the position controls, replacing the IDENTIFY pushbuttons formerly used on the unmodified unit.

APPLICATION. The added Offset facility should be used only for offsetting a DC level in the waveform to be observed. Amplifier characteristics are not suitable for use of this feature for "slideback" type measurements of peak or peak-to-peak high-frequency or pulse waveforms exceeding 15 divisions peak-to-peak amplitude.

CHARACTERISTICS

AMPLIFIER LINEAR OFFSET RANGE. Common-mode DC range of the input amplifiers is sufficient to provide linear amplification of signals within normal 7A18 performance specifications at offsets of up to ± 200 divisions.

EFFECTIVE VOLTAGE OFFSET. Effective voltage offset values for calibrated VOLTS/DIV steps are as follows (VARIABLE control in Cal position):

EFFECTIVE OFFSET RANGE

VOLTS/DIV	Direct	With X10 Probe
5 mV	± 1 V	± 10 V
10	2	20
20	4	40
50	10	100
.1 V	20	200
.2	40	400
.5	100	1000 ²
1	200	2000 ²
2	400 ¹	4000 ²
5	1000 ¹	10,000 ²

¹Maximum input rating 250 V when direct coupled. Full offset range should not be used above 1 V/DIV.

²Maximum input rating of most probes is 500—600 V. Full offset range should not be used at VOLTS/DIV settings above .2 with 10X probe.

CALIBRATION

CALIBRATION. Perform the following steps for checking Channel 1 and 2 OFFSET Range:

- a. Reset the Input coupling to GND and the VOLTS/DIV to 5 mV and position the trace to the center horizontal graticule line.
- b. Set the standard amplitude calibrator for one-volt +DC output and set the input coupling switch to DC OFFSET.
- c. CHECK—Using the OFFSET control, check that the trace can be returned to graticule center.
- d. Set the standard amplitude calibrator for a minus (–) one-volt DC output.
- e. CHECK—Using the OFFSET control, check that the trace can be returned to graticule center.

CIRCUIT DESCRIPTION. DC levels of up to ± 200 divisions can be offset by switching the input coupling to DC OFFSET and using the OFFSET control. In the DC OFFSET mode, the selected offset voltage from OFFSET control R12 (R22, CH 2), is applied to the base of Q320 (Q520, CH 2) through current-limiting resistor R320 (R520, CH 2). This additional bias voltage is used to balance the differential input of Q220 (Q420, CH 2). LED's are inserted in series with both CR220 and CR221 (CR420, CR421, CH 2) to allow a larger voltage swing at the base of Q220 (Q420, CH 2).

The schematics of the Option 6 circuits are shown on diagrams 1, 2 and 3.

OPTION 6 EXPLODED

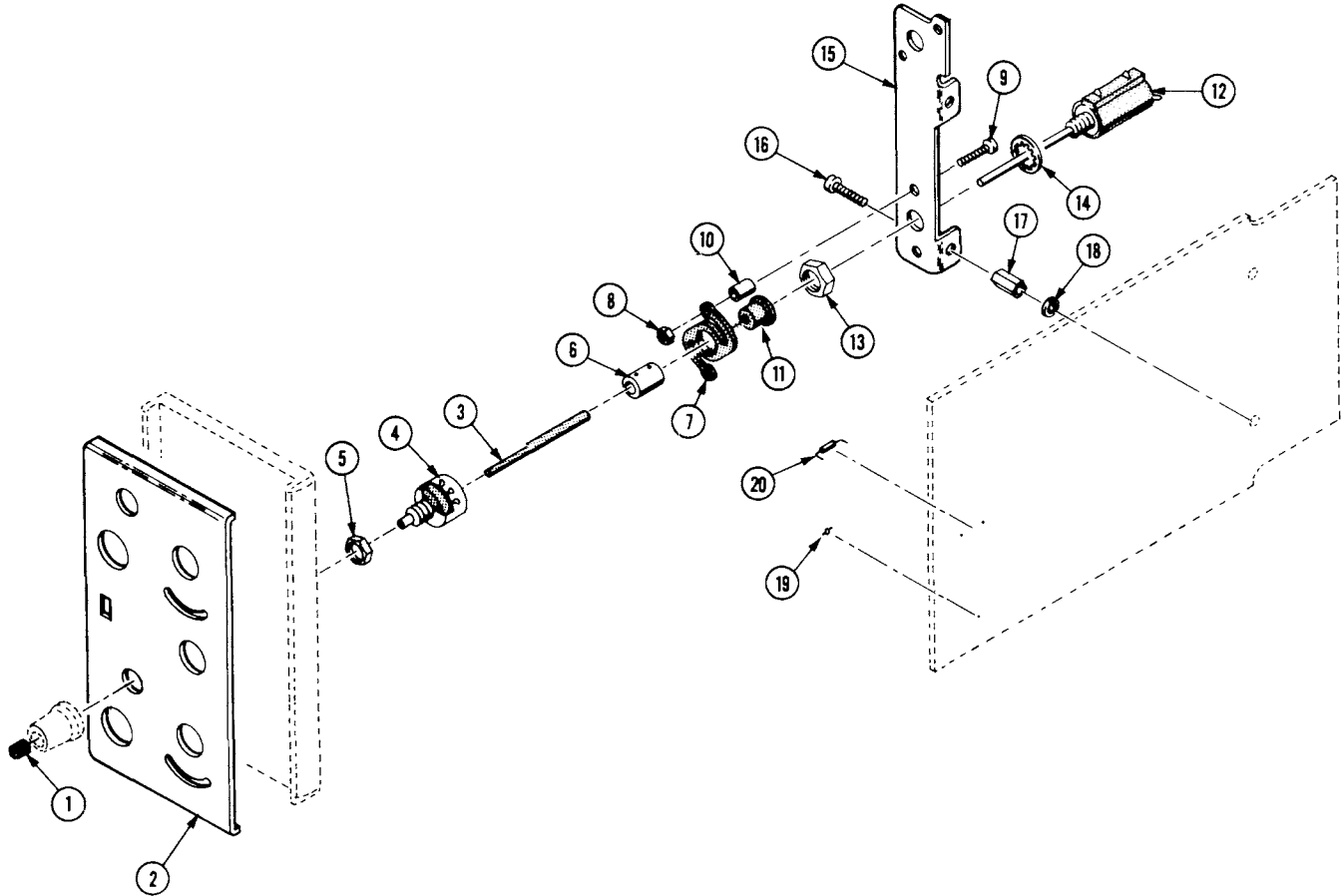

OPTION 6 REPLACEABLE PARTS LIST

Replacement parts should be ordered from the Tektronix Field Office or Representative in your area. Changes to Tektronix products give you the benefit of improved circuits and components. Please include the instrument type number and serial number with each order for parts or service.

ABBREVIATIONS

BHB	binding head brass	h	height or high	OHB	oval head brass
BHS	binding head steel	hex.	hexagonal	OHS	oval head steel
CRT	cathode-ray tube	HHB	hex head brass	PHB	pan head brass
csk	countersunk	HHS	hex head steel	PHS	pan head steel
DE	double end	HSB	hex socket brass	RHS	round head steel
FHB	flat head brass	HSS	hex socket steel	SE	single end
FHS	flat head steel	ID	inside diameter	THB	truss head brass
Fil HB	fillister head brass	lg	length or long	THS	truss head steel
Fil HS	fillister head steel	OD	outside diameter	w	wide or width

Fig. & Index No.	Tektronix Part No.	Serial/Model No.		Q † y	Description
		Eff	Disc		
-1	366-1319-00			2	KNOB, gray-- IDENTIFY (CH1 & CH2) - each knob includes:
	213-0306-00			1	. SETSCREW, 2-56 X 0.062 inch, HSS
-2	333-1939-00			1	PANEL, front
-3	384-1313-00			2	SHAFT, extension, stepped
-4	311-1144-00			2	RESISTOR, var--5k OHM (R11 & R12) - mounting hardware for each: (not included w/resistor)
-5	210-0583-00			1	NUT, hex., 0.25-32 X 0.312 inch
-6	376-0039-00			2	COUPLING, shaft, 0.312 OD X 0.438 inch long - . each coupler includes:
	213-0075-00			2	. SETSCREW, 4-40 X 0.094 inch, HSS
-7	426-0261-00			2	MOUNT, flexible - mounting hardware for each: (not included w/mount)
-8	210-0405-00			2	NUT, hex., 2-56 X 0.188 inch, STL
-9	211-0081-00			2	SCREW, 2-56 X 0.562 inch, STL
-10	166-0251-00			2	TUBE, spacer, 0.296 inch, long
-11	105-0296-00			2	BRAKE, shaft
-12	311-0889-00			2	RESISTOR, var--5k OHM, 10 turn (R12 & R22) - mounting hardware for each: (not included w/resistor)
-13	210-0583-00			1	NUT, hex., 0.25-32 X 0.312 inch, STL
-14	210-0046-00			2	WASHER, lock, internal, 0.261 ID X 0.400 OD, STL
-15	407-1566-00			1	BRACKET, angle, component mtg - mounting hardware: (not included w/bracket)
-16	211-0008-00			2	SCREW, 4-50 X 0.25 inch, PNH, STL
-17	129-0299-00			2	POST, hex., 4-40 X 0.188 X 0.335 inch long
-18	210-0004-00			2	WASHER, lock, internal, 0.12 ID X 0.26 inch OD, STL
-19	150-1000-00			4	LAMP, LED: 2V, 40A (DS220, DS221, DS420 & DS421)
-20	315-0332-00			2	RESISTOR, 3.3k OHM, 114W, 5% (R320 & R520)
	175-0825-00			ft	WIRE, electrical, 2 wire ribbon, 24 inches long
	175-0827-00			ft	WIRE, electrical, 4 wire ribbon, 10.50 inches long

SECTION 7

DIAGRAMS AND CIRCUIT BOARD ILLUSTRATIONS

Symbols and Reference Designators

Electrical components shown on the diagrams are in the following units unless noted otherwise:

Capacitors = Values one or greater are in picofarads (pF).
 Values less than one are in microfarads (μ F).
 Resistors = Ohms (Ω)

Symbols used on the diagrams are based on USA Standard Y32.2-1967.

Logic symbology is based on MIL-STD-806B in terms of positive logic. Logic symbols depict the logic function performed and may differ from the manufacturer's data.

The following special symbols are used on the diagrams:

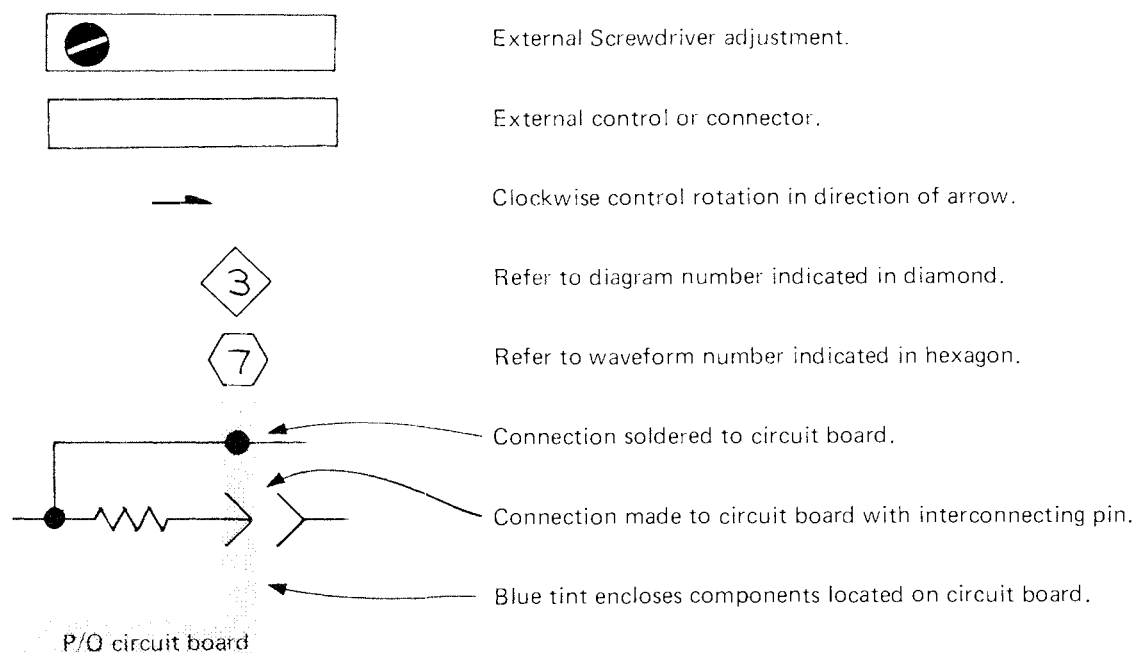

The following prefix letters are used as reference designators to identify components or assemblies on the diagrams.

A	Assembly, separable or repairable (circuit board, etc.)	LR	Inductor/resistor combination
AT	Attenuator, fixed or variable	M	Meter
B	Motor	Q	Transistor or silicon-controlled rectifier
BT	Battery	P	Connector, movable portion
C	Capacitor, fixed or variable	R	Resistor, fixed or variable
CR	Diode, signal or rectifier	RT	Thermistor
DL	Delay line	S	Switch
DS	Indicating device (lamp)	T	Transformer
F	Fuse	TP	Test point
FL	Filter	U	Assembly, inseparable or non-repairable (integrated circuit, etc.)
H	Heat dissipating device (heat sink, heat radiator, etc.)	V	Electron tube
HR	Heater	VR	Voltage regulator (zener diode, etc.)
J	Connector, stationary portion	Y	Crystal
K	Relay		
L	Inductor, fixed or variable		

VOLTAGE AND WAVEFORM TEST CONDITIONS

Typical voltage measurements were obtained under the following conditions unless noted otherwise on the individual diagrams:

Voltmeter

Type	Non-loading digital multimeter
Input impedance	10 MΩ
Range	0 to 1000 volts
Recommended type (as used for voltages on diagrams)	Tektronix 7D13 Digital Multimeter

7A18 (left vertical compartment)

DISPLAY MODE	ALT
TRIGGER SOURCE	MODE
CH 2 POLARITY	+UP

CH 1 and CH 2

VOLTS/DIV	10 mV
COUPLING	DC
POSITION	Centered
VARIABLE	CAL IN
Signal Applied	No signal for voltage measurements, 40 mV square wave from oscilloscope Calibrator applied to both input connectors for waveforms.

7A16 (right vertical compartment using a 10X probe with readout coding ring. P6053 probe used for waveforms on diagrams)

Polarity	+UP
Bandwidth	Full
Position	Centered
Coupling	AC
Variable	Cal In

7B70 (A Horizontal compartment)

Level/Slope	Centered on positive slope
Triggering Mode	P-P Auto
Coupling	AC
Source	Ext
Magnifier	X1
Time/Div	1 ms
Variable	Cal In
Ext Trig In connector	No connection for voltage measurements. For waveforms Sig Out from oscilloscope connected to Ext Trig In connector.

7704

Vertical Mode	Right
Horizontal Mode	A
A Intensity	Optimum
B Intensity	Counterclockwise
Calibrator	
Volts	40 mV
Rate	1 kHz
A Trigger Source	Right Vert
B Trigger Source	Left Vert

All voltages given on the diagrams are in volts. All currents are in milliamps. Waveforms shown are actual waveform photographs taken with a Tektronix Oscilloscope Camera System. Vertical deflection factor shown on waveform is the actual deflection factor from the probe tip. Voltages and waveforms on the diagrams (shown in blue) are not absolute and may vary between instruments because of component tolerances, internal calibration or front panel settings. Readouts are simulated in larger-than-normal type.

NOTE

The spring tension of the pin sockets ensures a good connection between the circuit board and pin. This spring tension may be damaged by using the pin sockets as a connecting point for spring-loaded probe tips, alligator clips, etc.

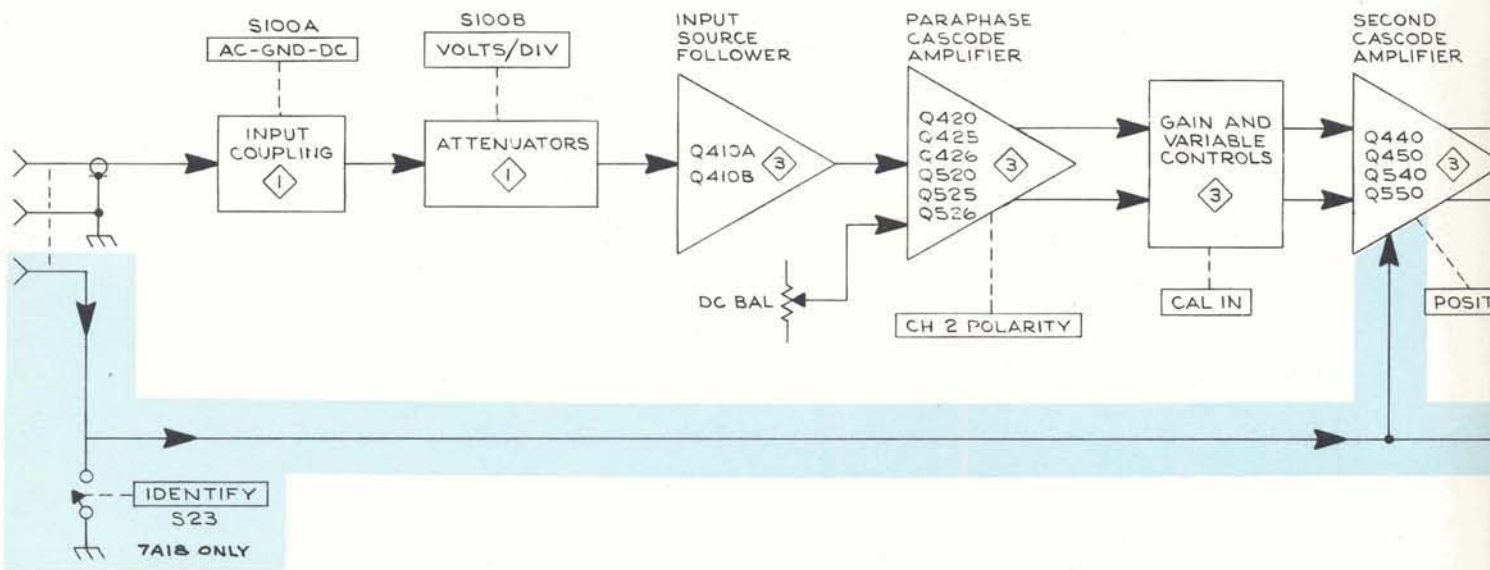
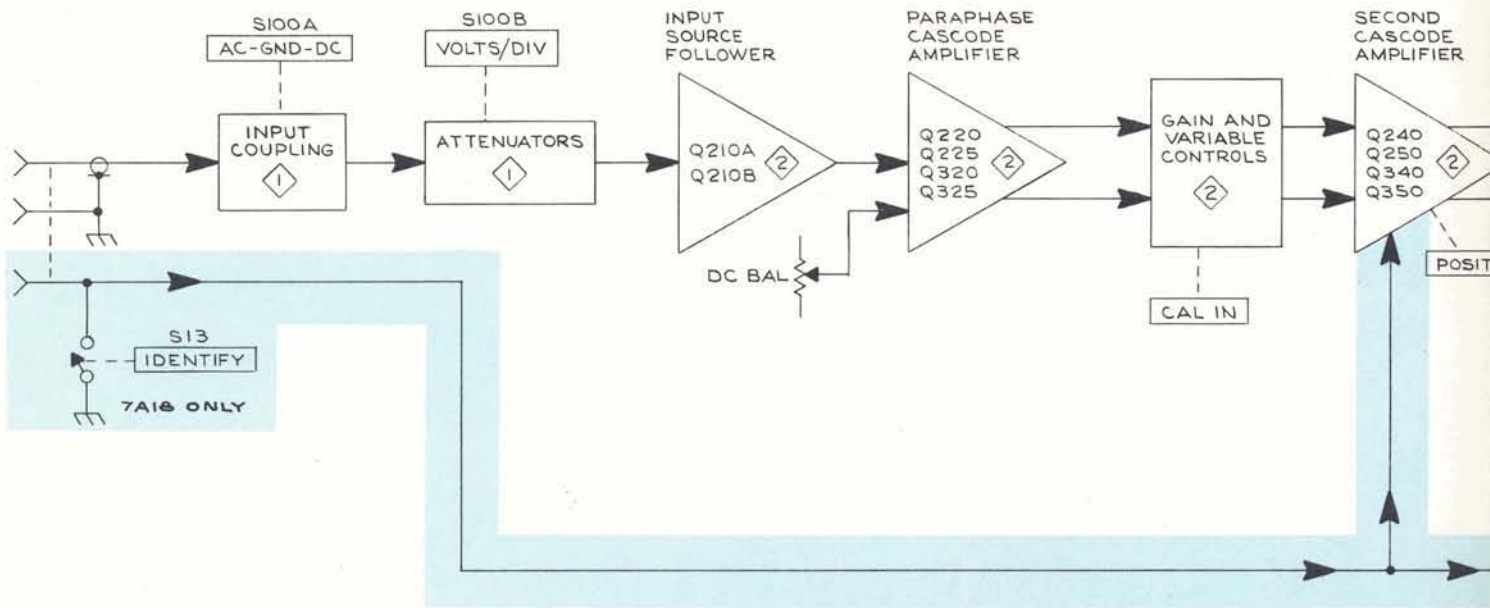

+
7A18/7A18N

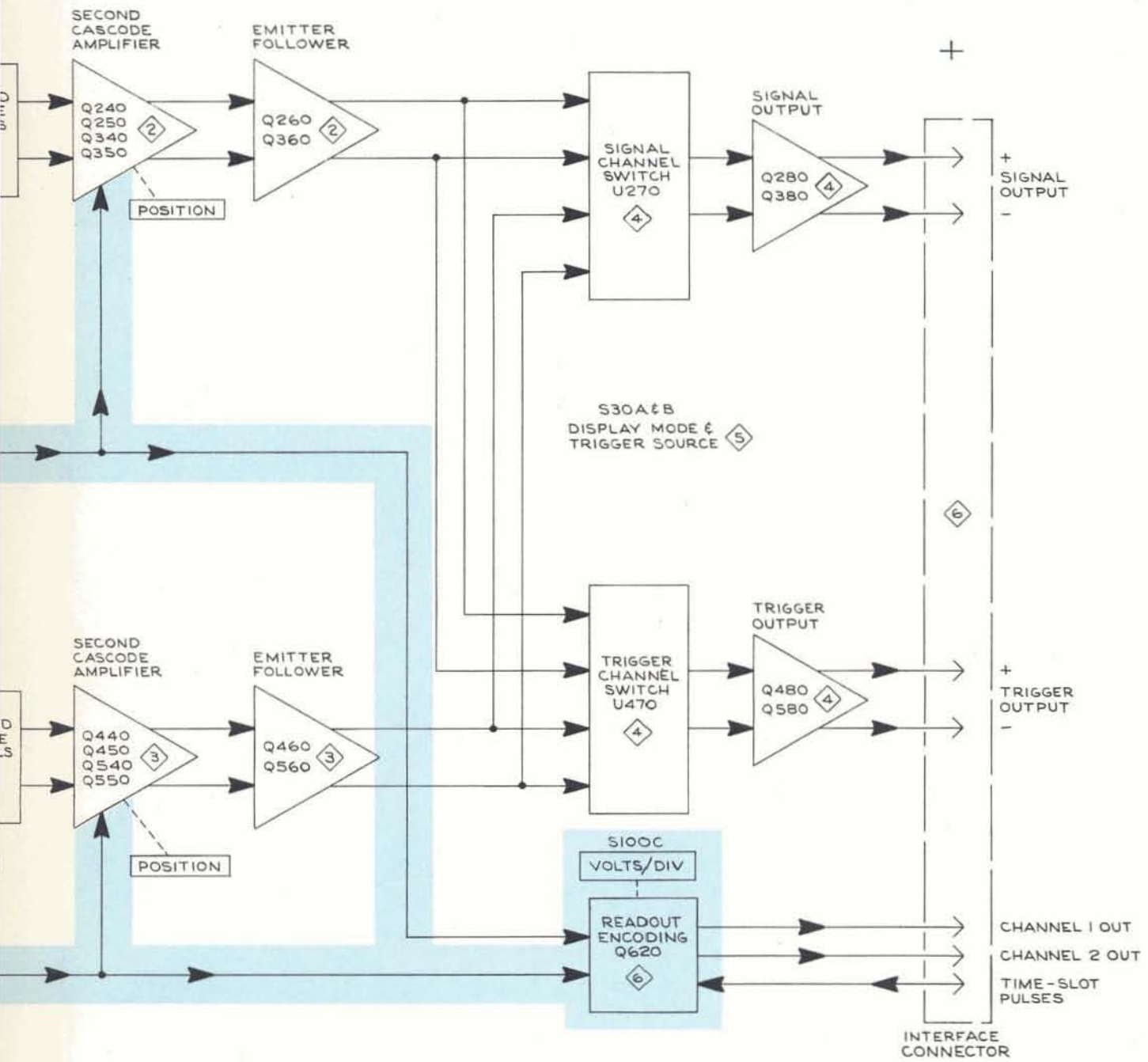

BLOCK DIAGRAM

GRS/hq
1171
BLOCK DIAGRAM

S100B

VOLTS/DIV (SHOWN IN 5mv POSITION)

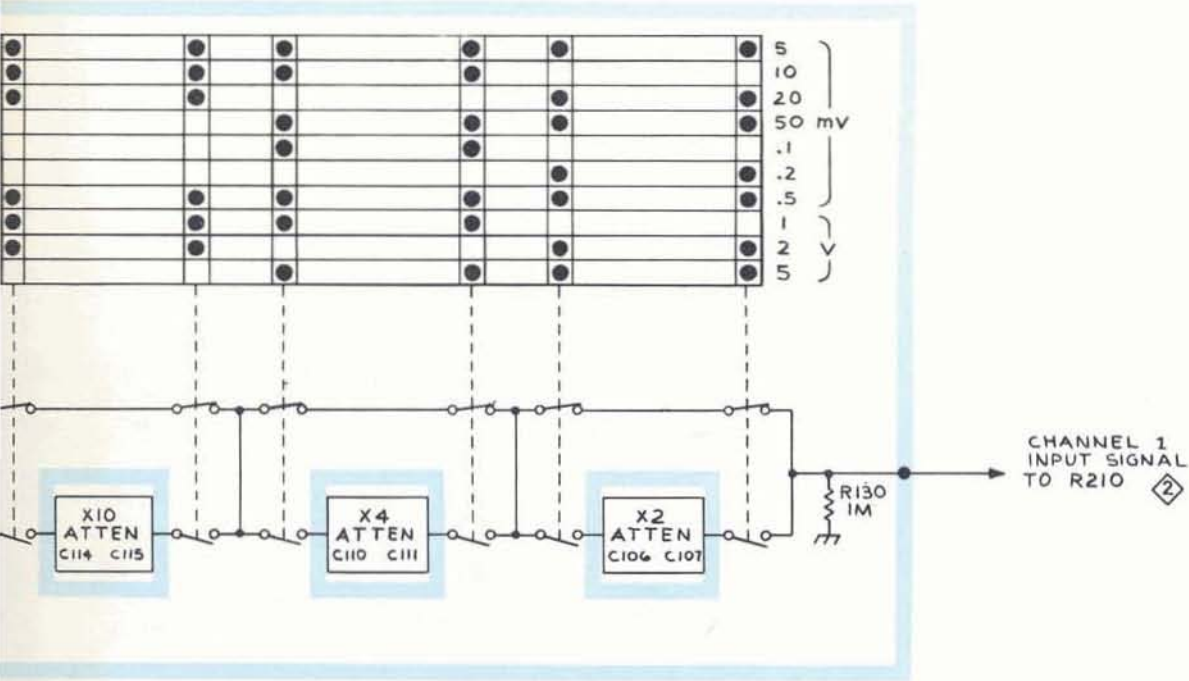

CHANNEL 1

S100B

VOLTS/DIV

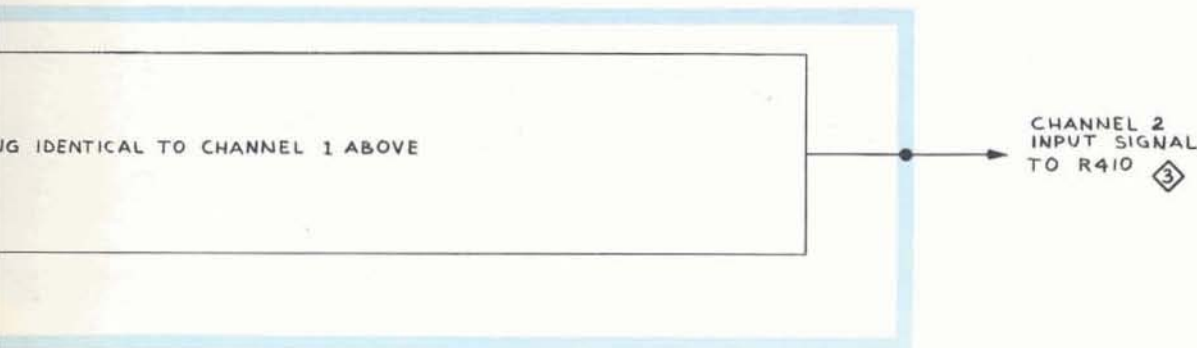

CHANNEL 2

SEE PARTS LIST FOR EARLIER VALUES AND SERIAL NUMBERED RANGES OF PARTS MARKED WITH BLUE OUTFINE

(A)

ATTENUATOR ①

EKP 374

ATTENUATOR OPTION 6 ①

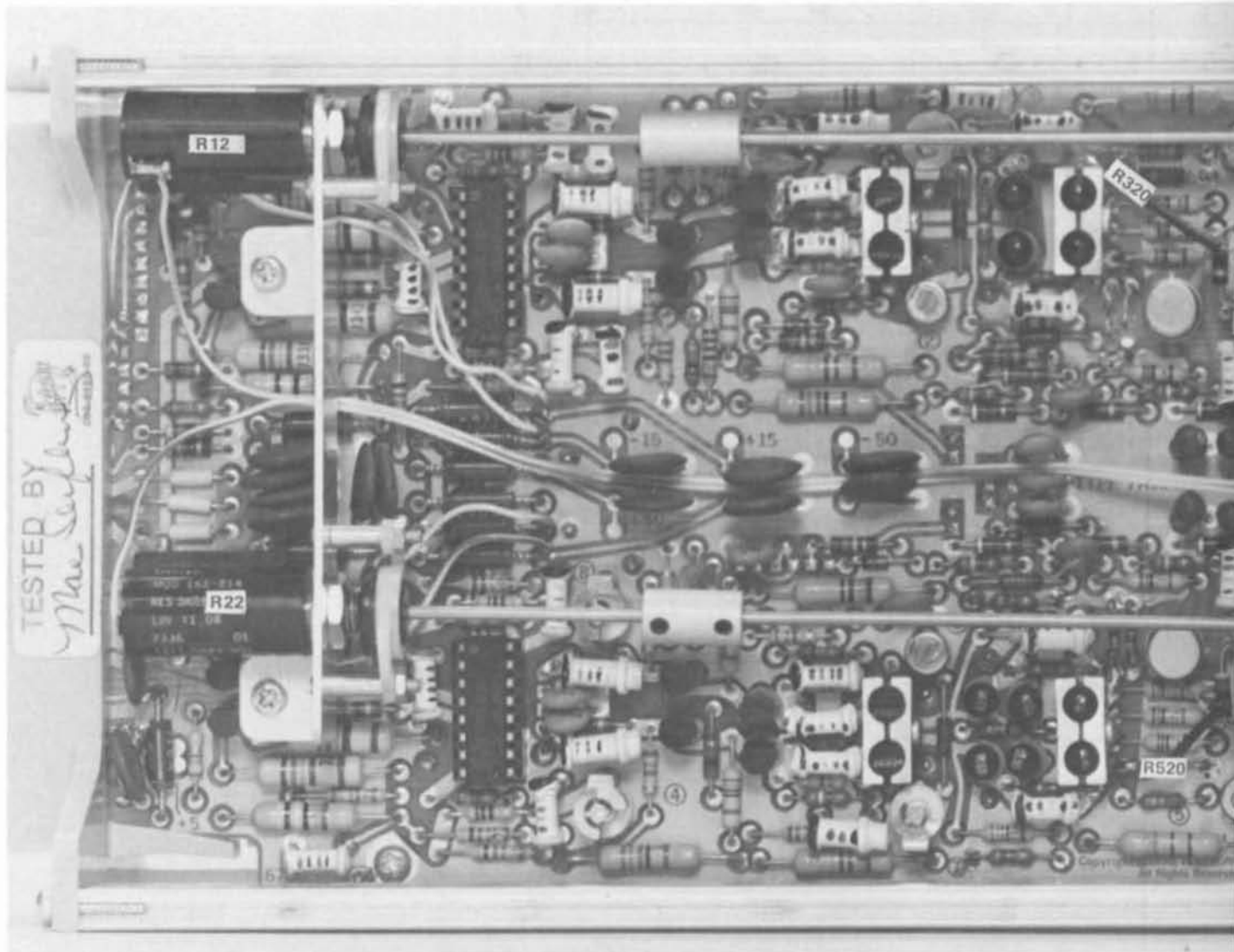
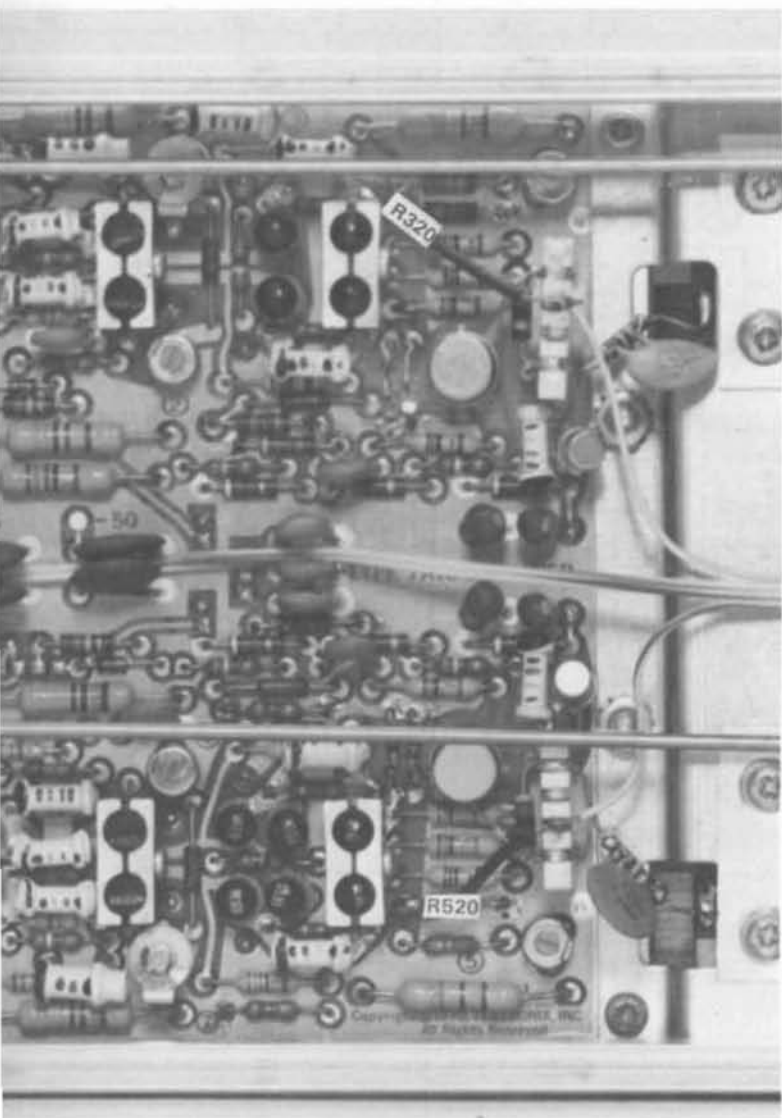
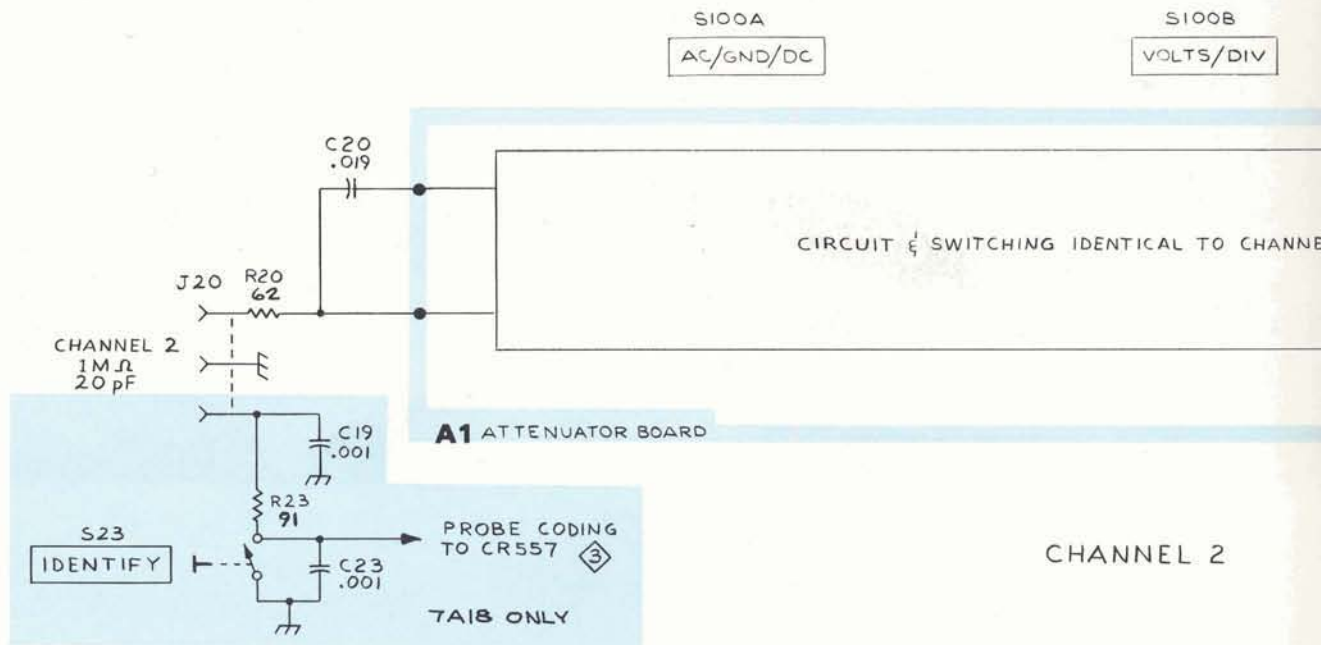
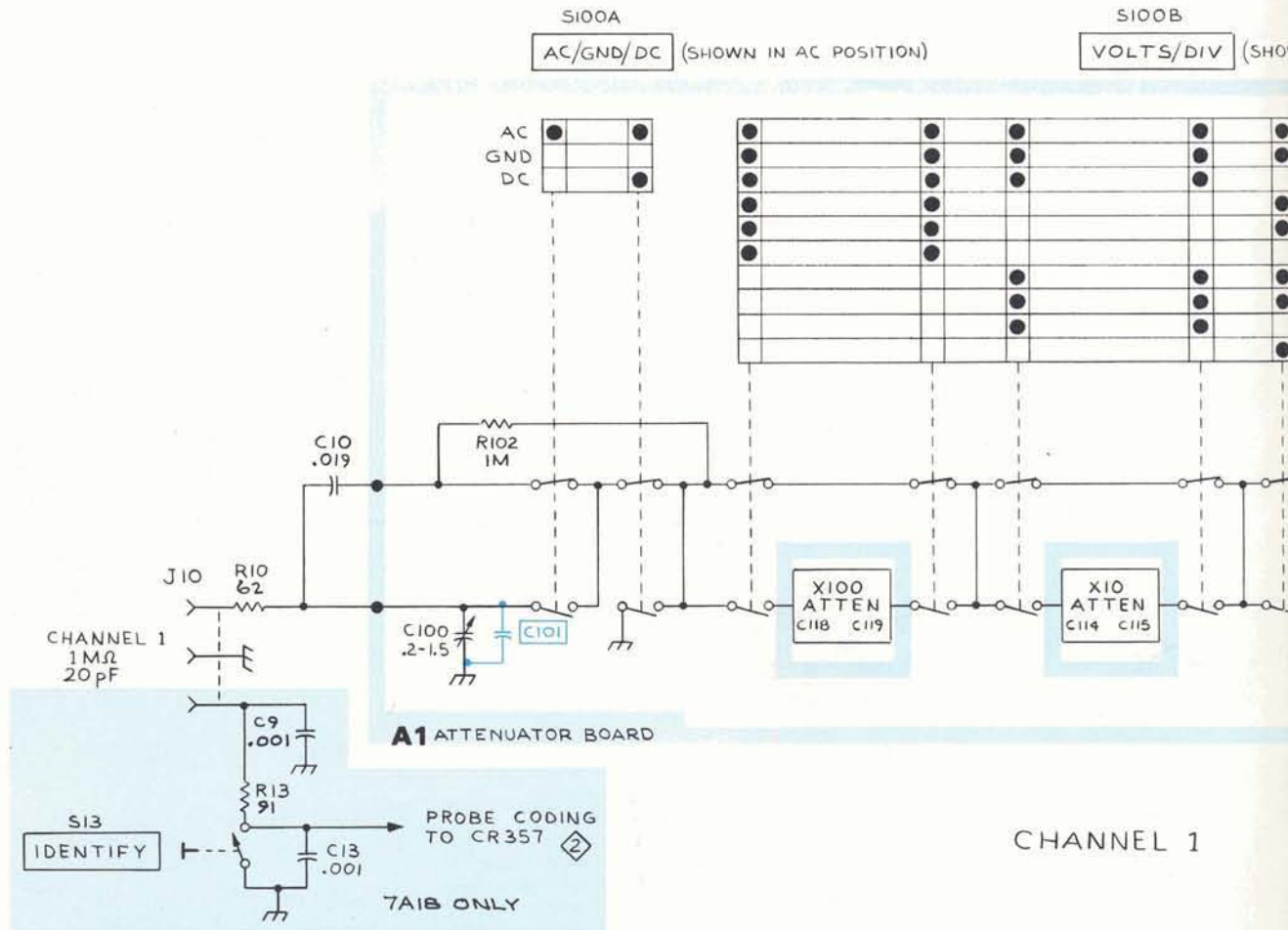

Fig. 7-1A. Amplifier Circuit Board Assembly, Option 6.



Assembly, Option 6.

Ⓐ



+

S100B

VOLTS/DIV (SHOWN IN 5mv POSITION)

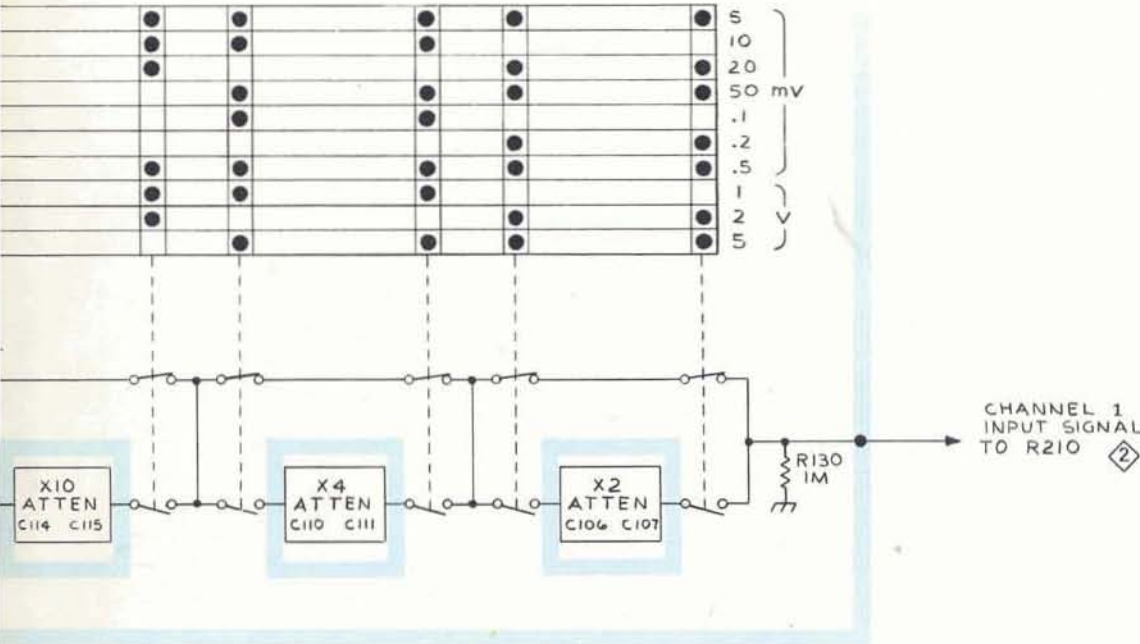

CHANNEL 1

S100B

VOLTS/DIV

IDENTICAL TO CHANNEL 1 ABOVE

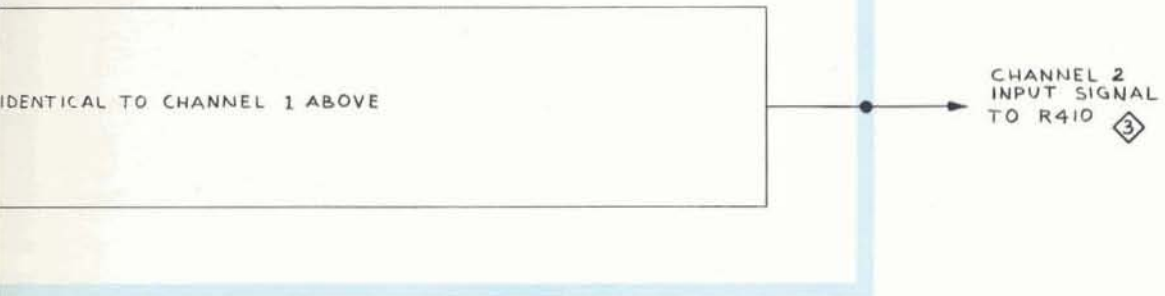

CHANNEL 2

SEE PARTS LIST FOR VALUES AND SERIAL NUMBER RANGES OF PARTS MARKED WITH THIS SYMBOL

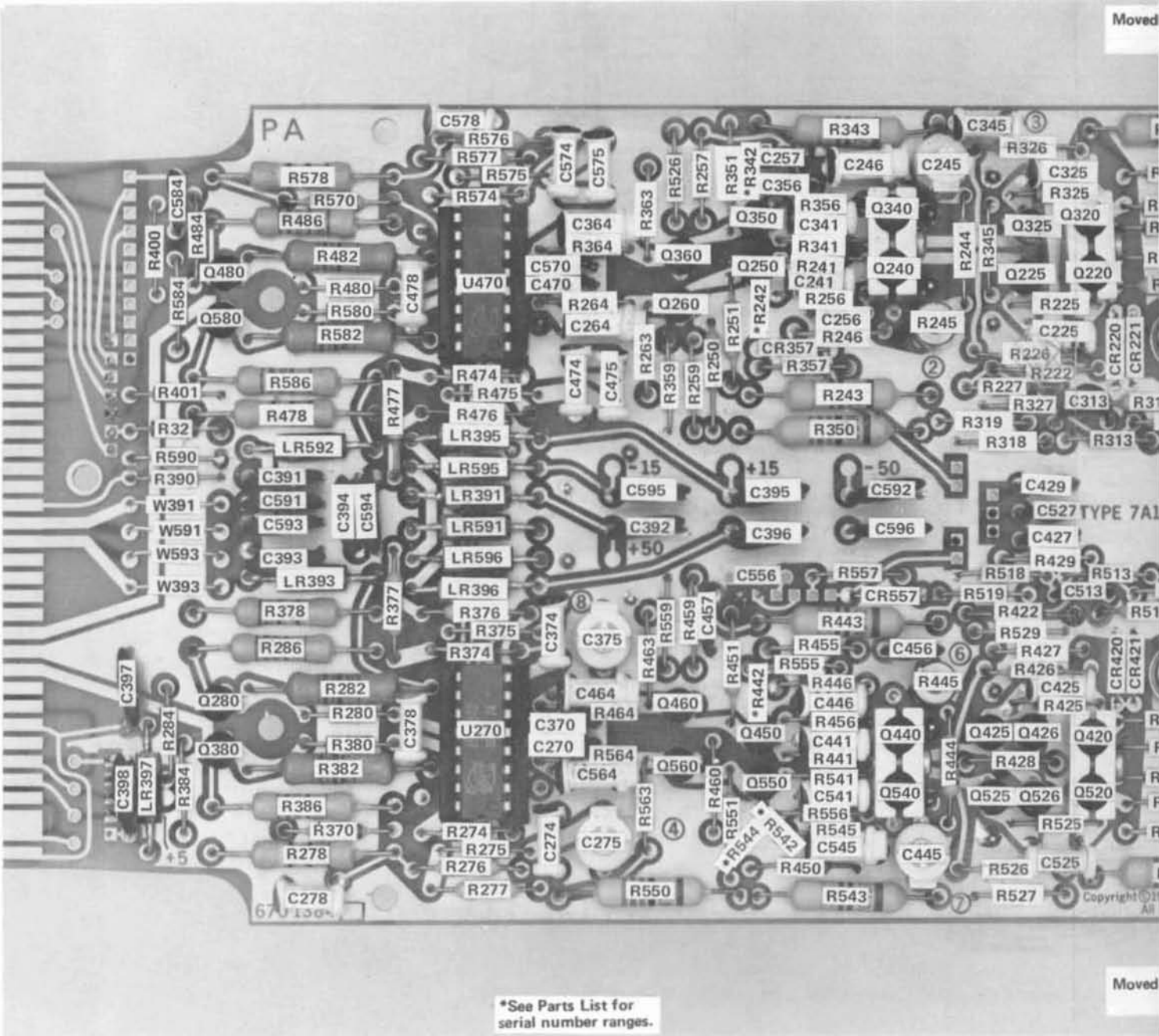

*See Parts List for serial number ranges.

Fig. 7-1. A2 Amplifier Circuit Board Assembly (front view).

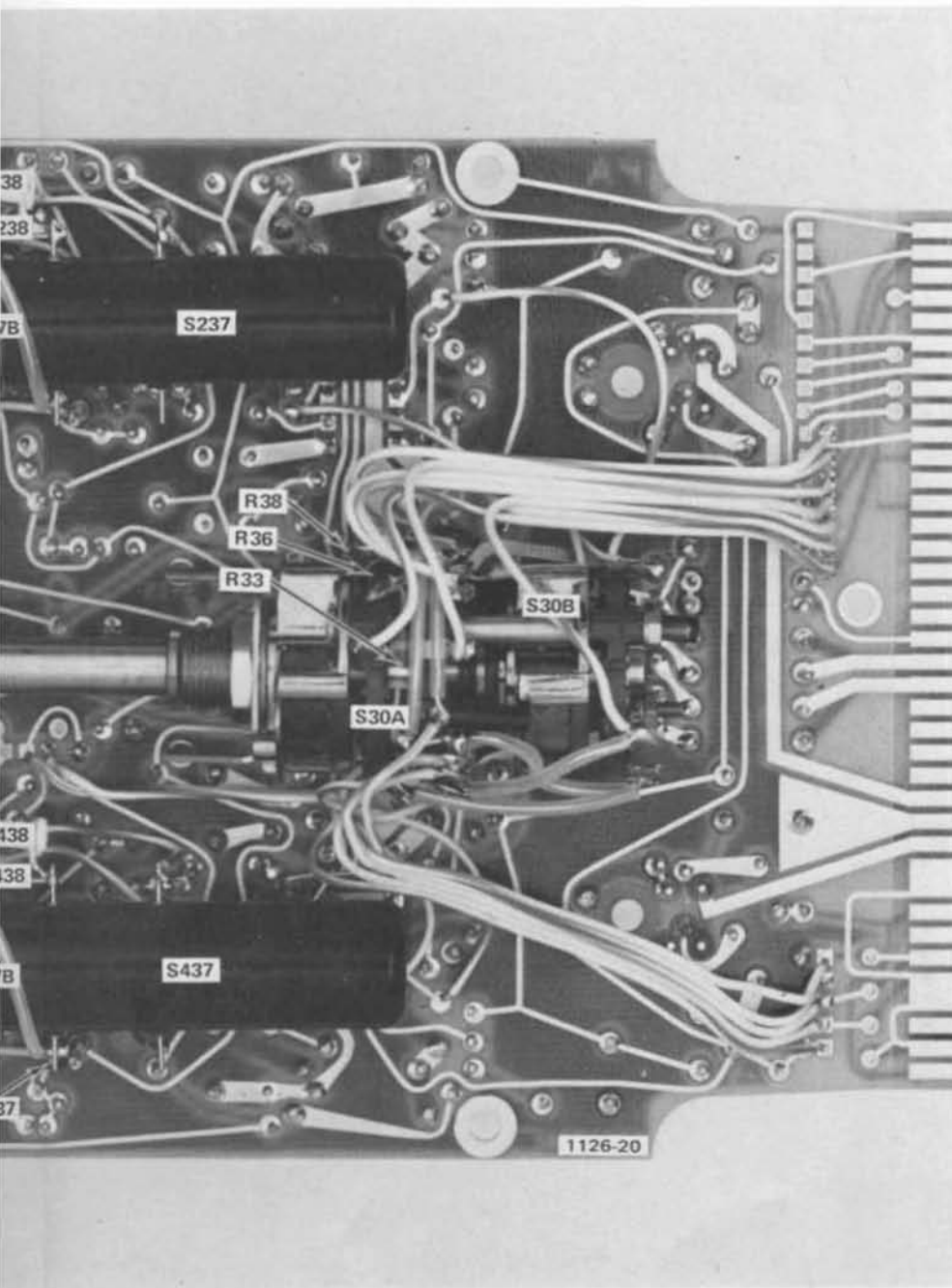

er Circuit Board Assembly (back view).

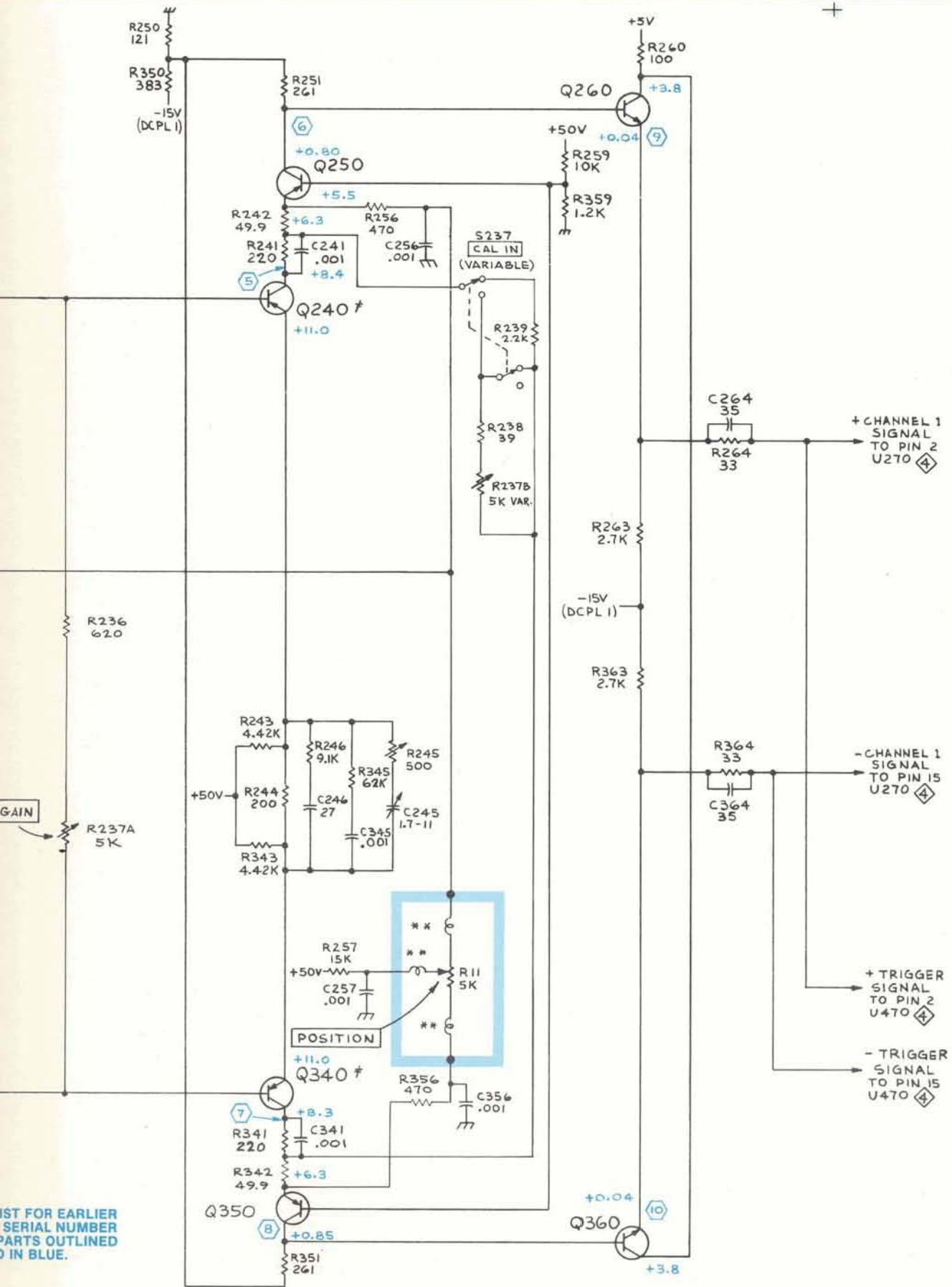

LIST FOR EARLIER SERIAL NUMBER PARTS OUTLINED IN BLUE.

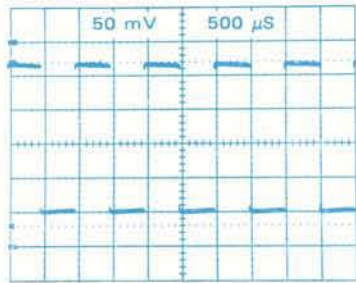

1

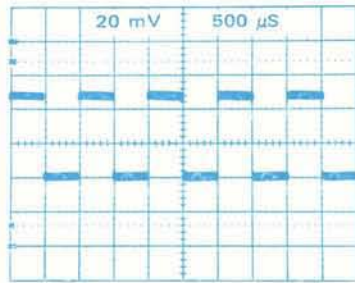

2

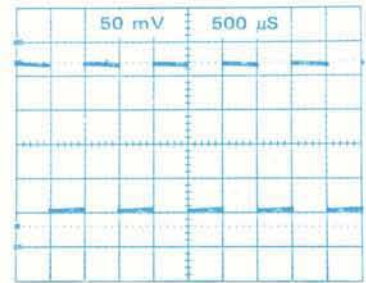

3

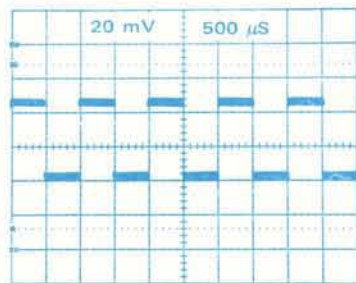

4

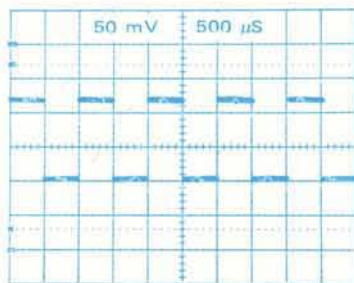

5

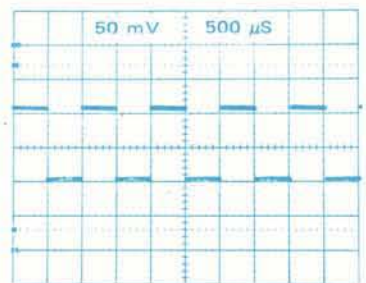

6

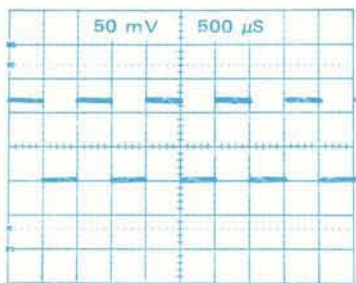

7

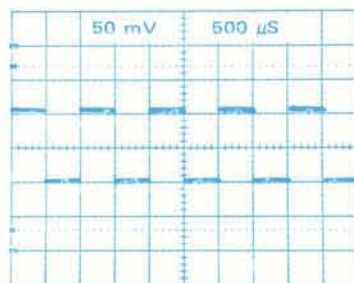

8

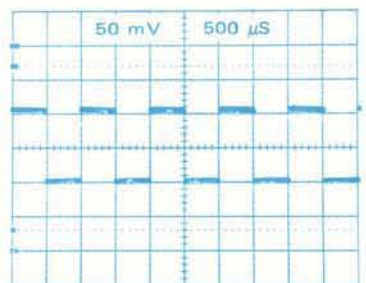

9

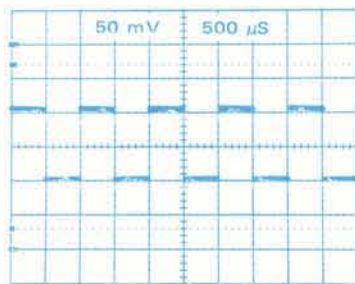

10

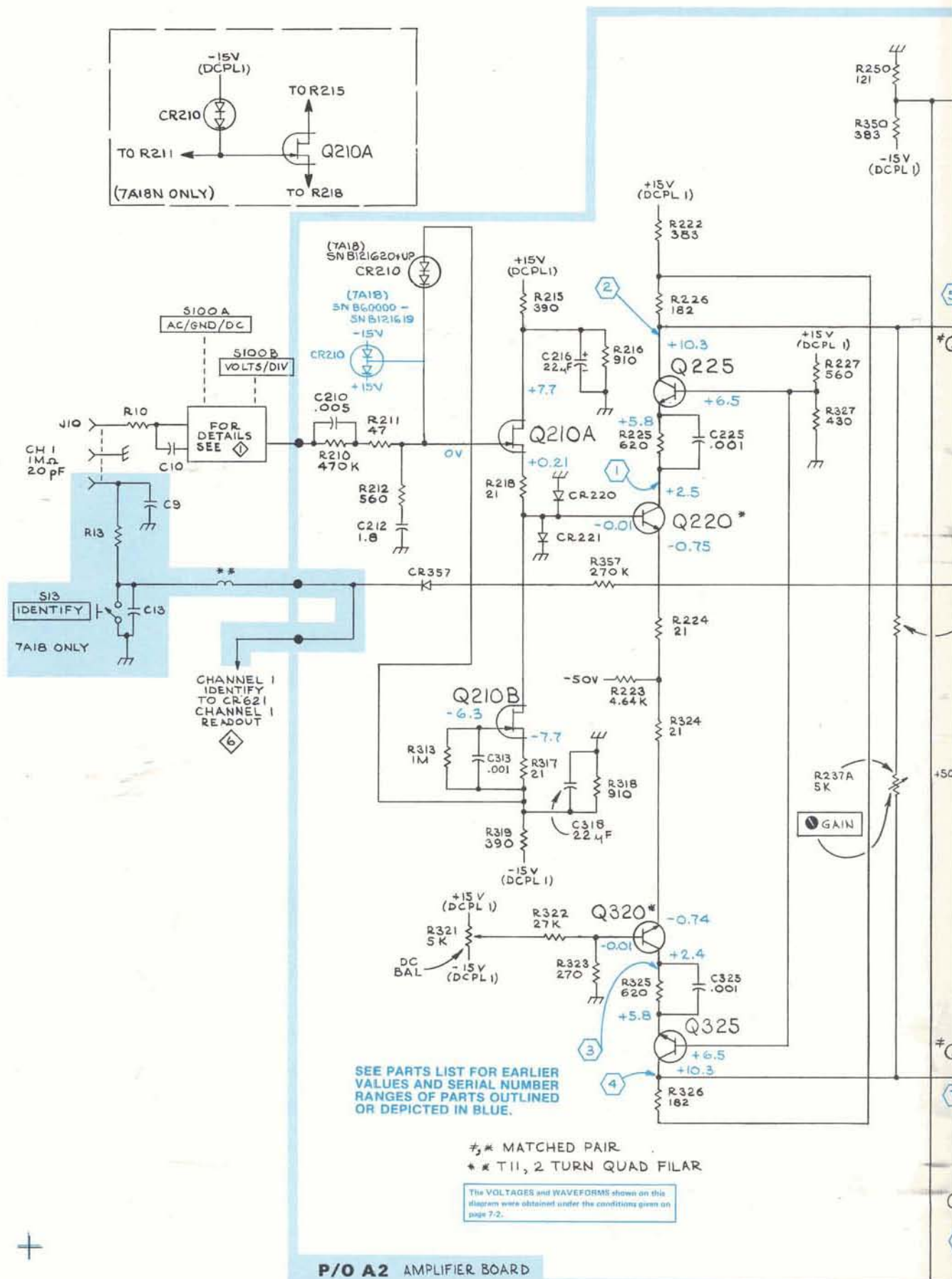

P/O A2 AMPLIFIER BOARD

7A18/7A18N

REV. F, MAY 1976
1126-23

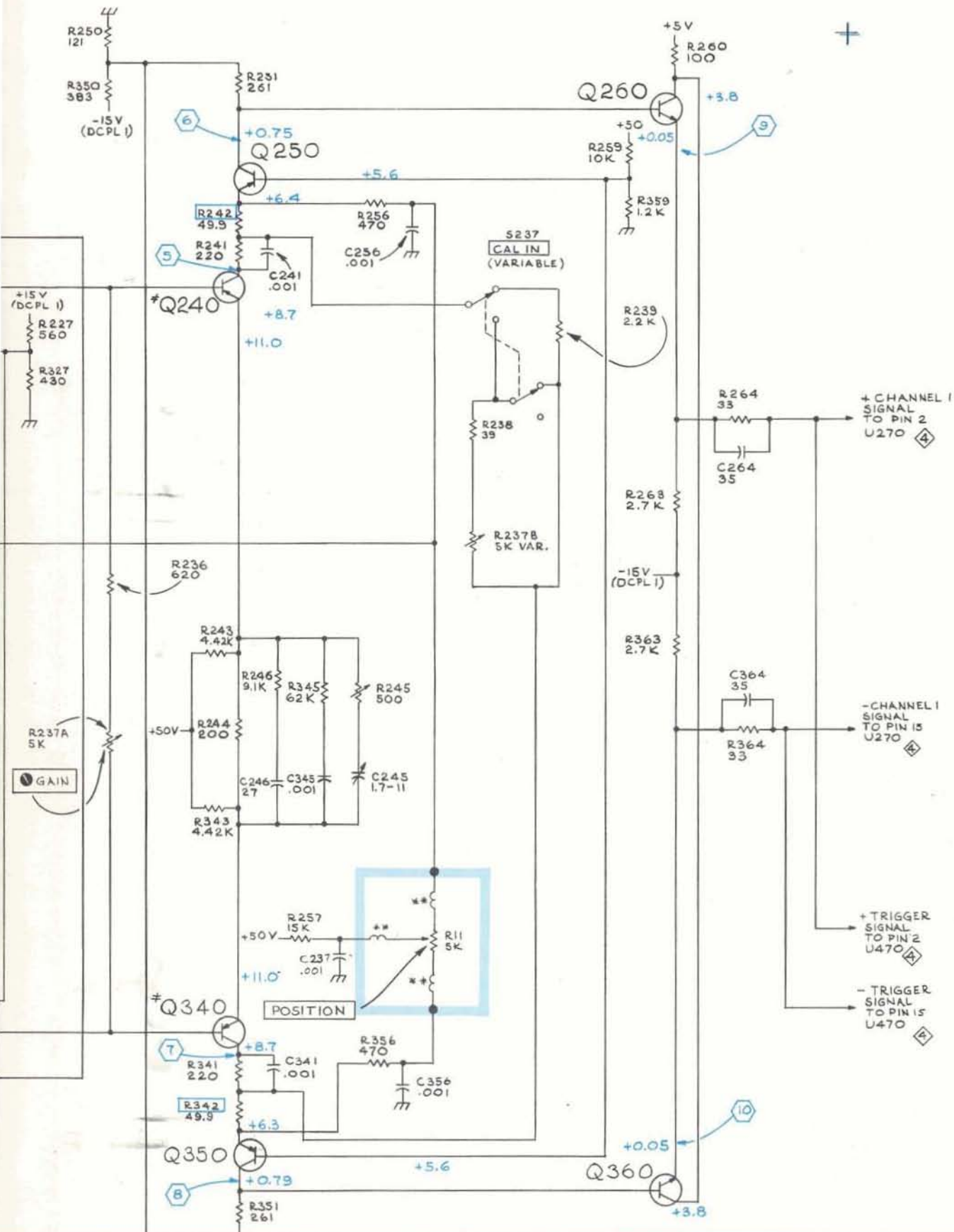

F, MAY 1976
6-23

CHANNEL 1 INPUT AMPLIFIER ◇
SN B060000 - UP R.E.C. 474

CH 1 INPUT AMP
SN B060000-up

2

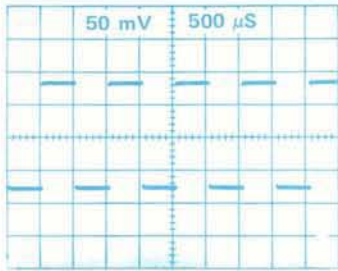

1

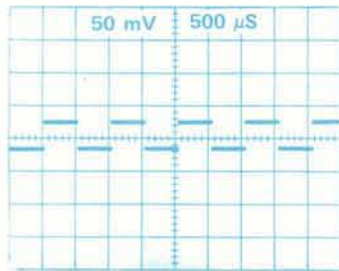

2

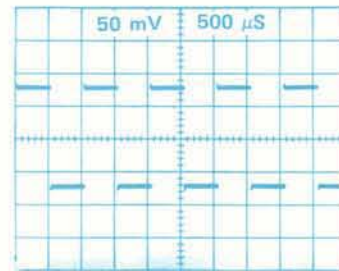

3

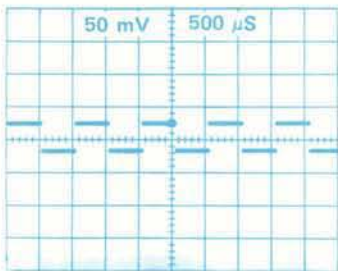

4

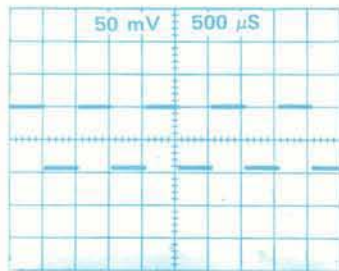

5

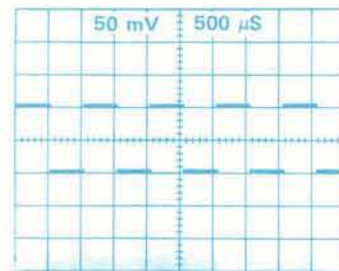

6

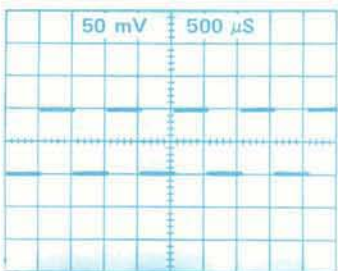

7

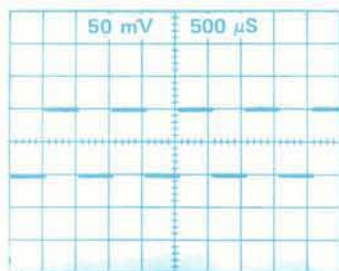

8

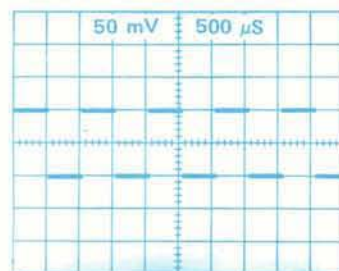

9

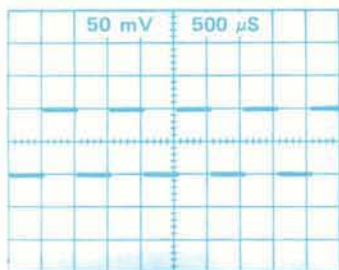

10

VOLTAGES and WAVEFORMS obtained under conditions given on page 7-2.

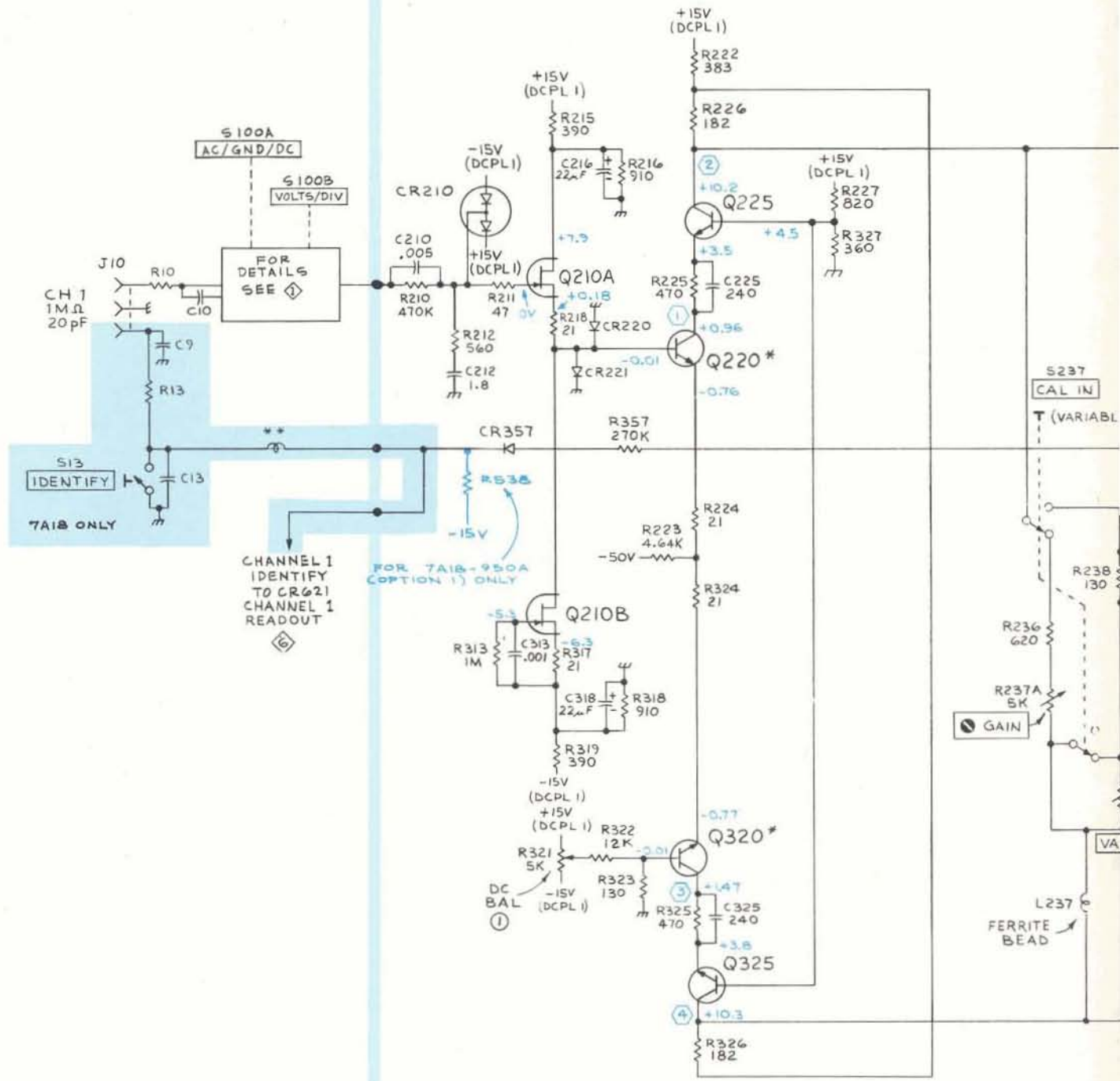

** MATCHED PAIR
 ** T11, 2 TURN QUAD FILAR

P/O A2 AMPLIFIER BOARD

7A18/7A18N

©

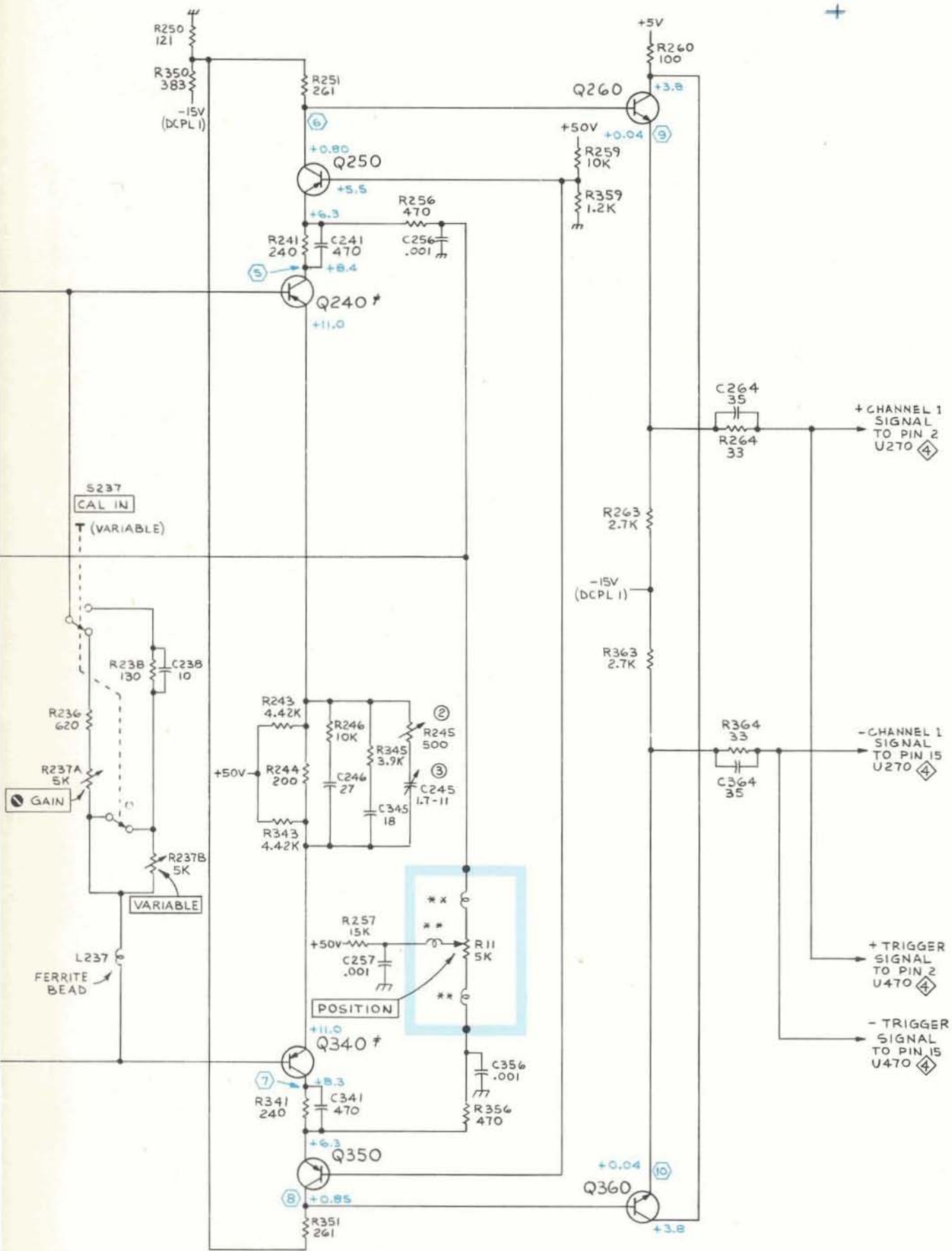

CHANNEL 1 INPUT AMPLIFIER 2 / hq
 BELOW SNB060000
 REV. APR 1974

CH 1 INPUT AMP
 BELOW SN B060000

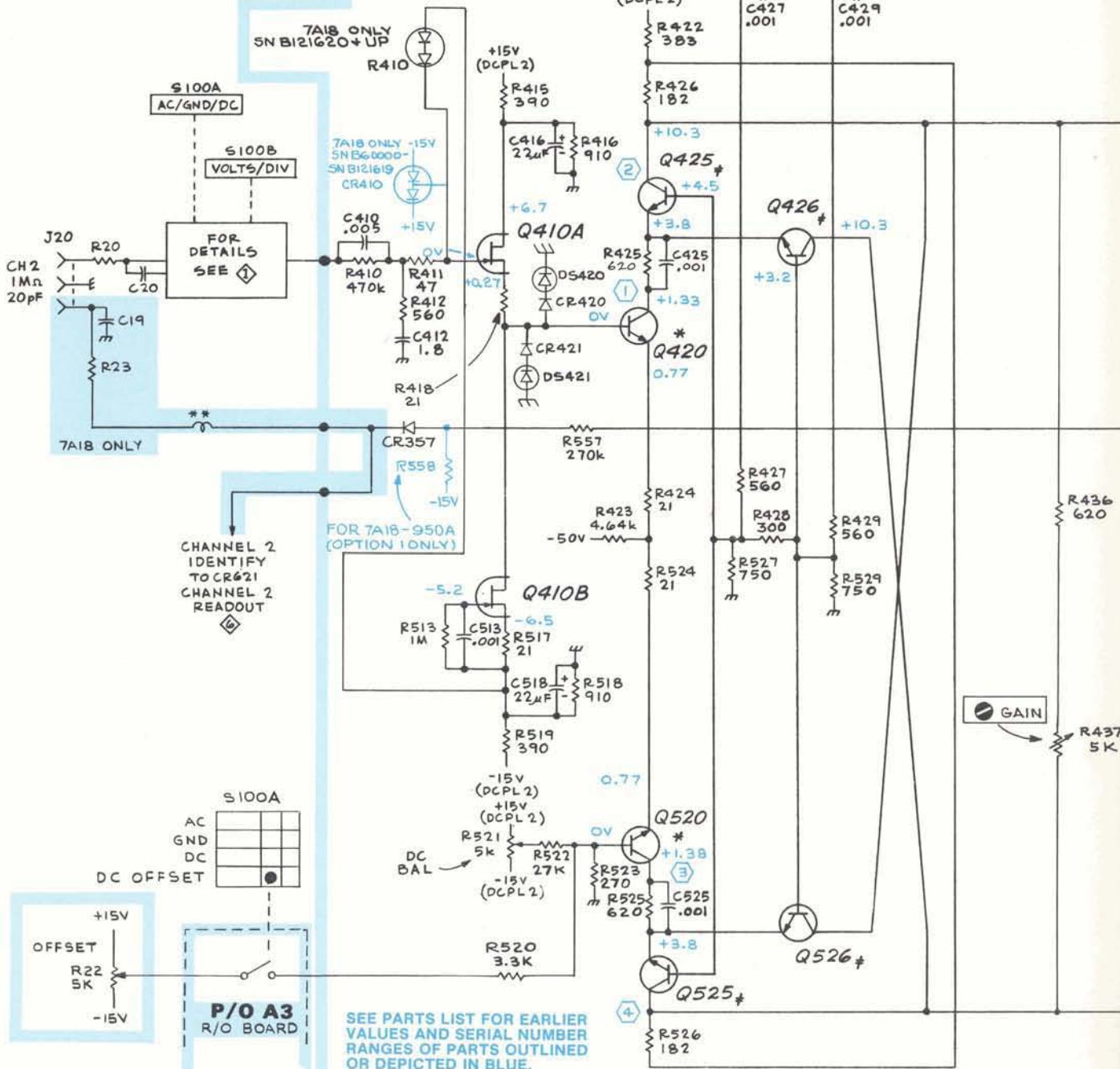
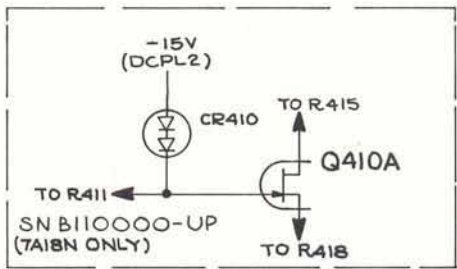

CHANNEL 2 IDENTIFY TO CR421 CHANNEL 2 READOUT

FOR 7A18-950A (OPTION 1 ONLY)

S100A

AC			
GND			
DC			
DC OFFSET			●

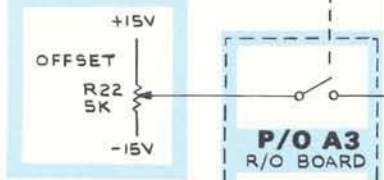

SEE PARTS LIST FOR EARLIER VALUES AND SERIAL NUMBER RANGES OF PARTS OUTLINED OR DEPICTED IN BLUE.

The VOLTAGES and WAVEFORMS shown on this diagram were obtained under the conditions given on page 7.2.

- * MATCHED PAIR
- † 4 MATCHED TRANSISTORS
- ** T21, 2 TURN QUAD FILAR

P/O A2 AMPLIFIER BOARD

7A18/7A18N OPTION 6

REV. F, MAY 1976
1126-26

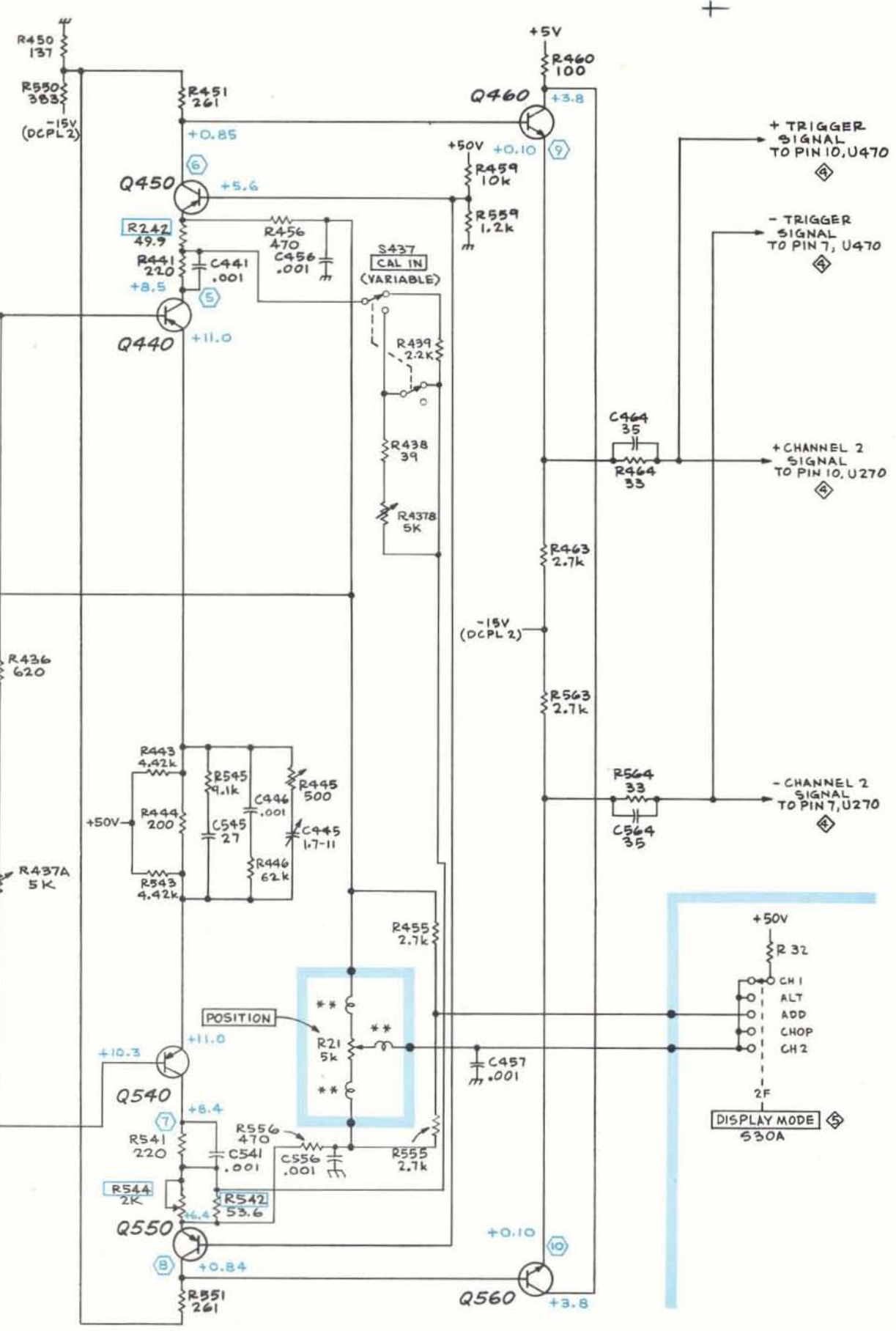

CHANNEL 2 INPUT AMPLIFIER

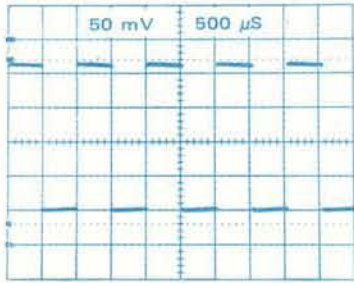

1

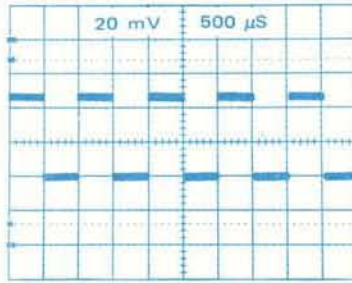

2

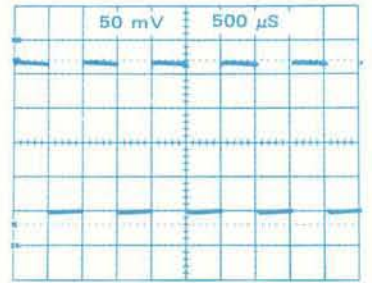

3

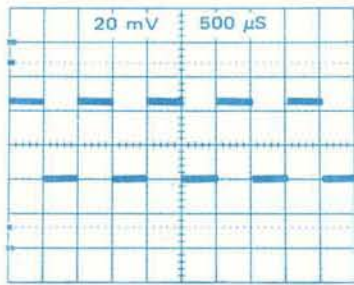

4

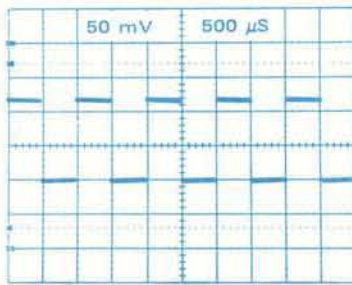

5

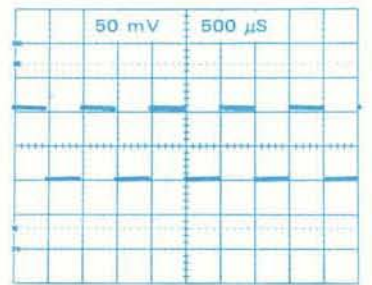

6

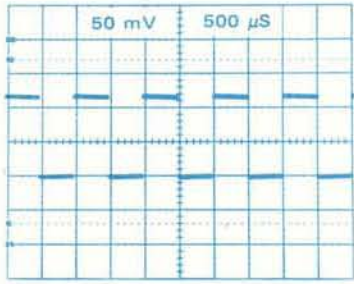

7

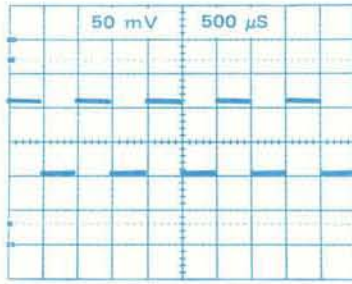

8

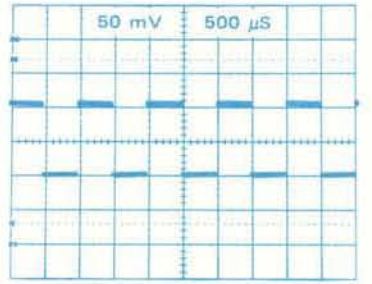

9

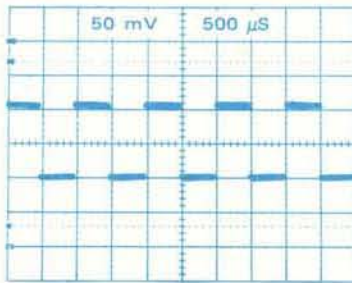

10

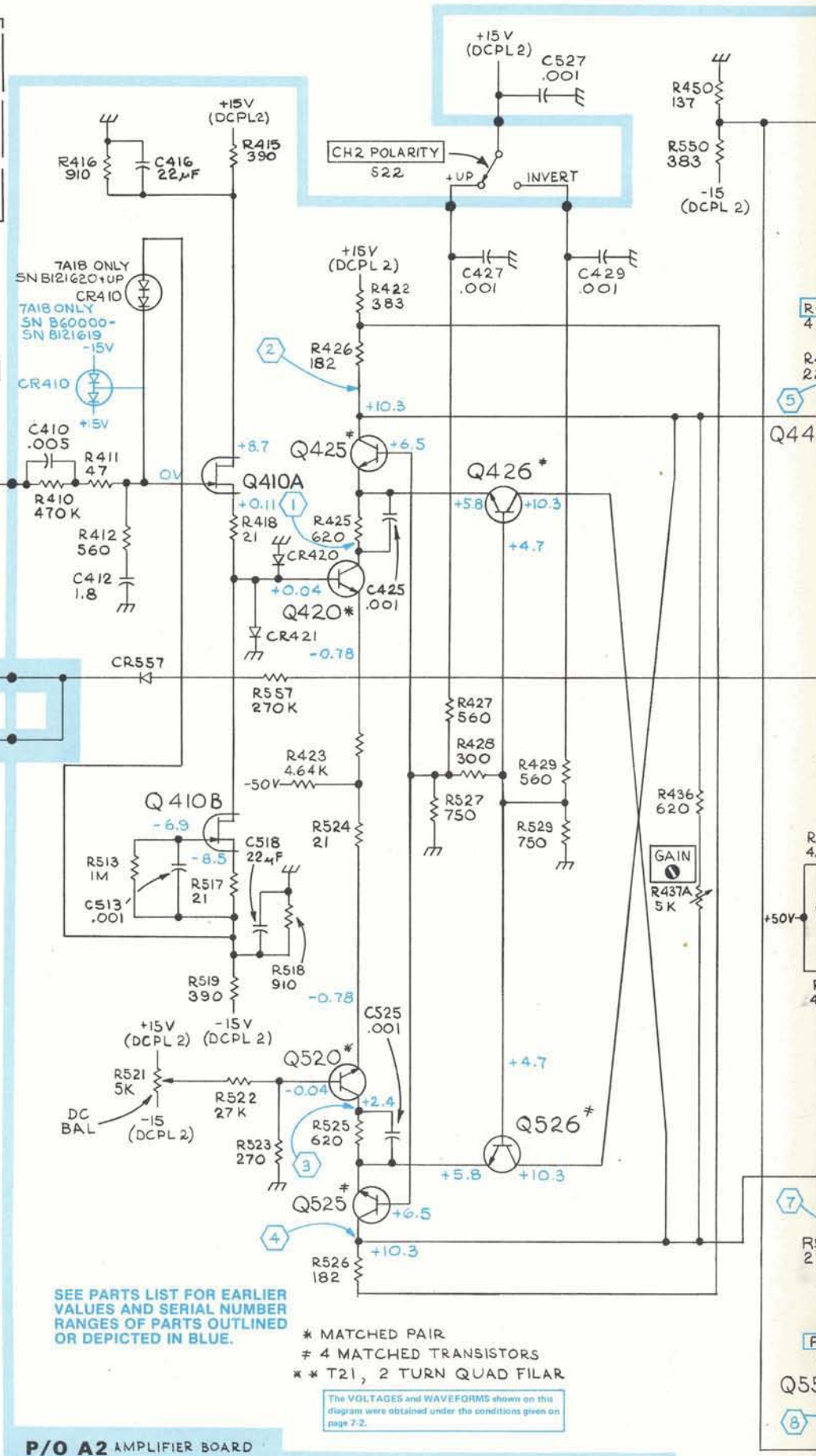
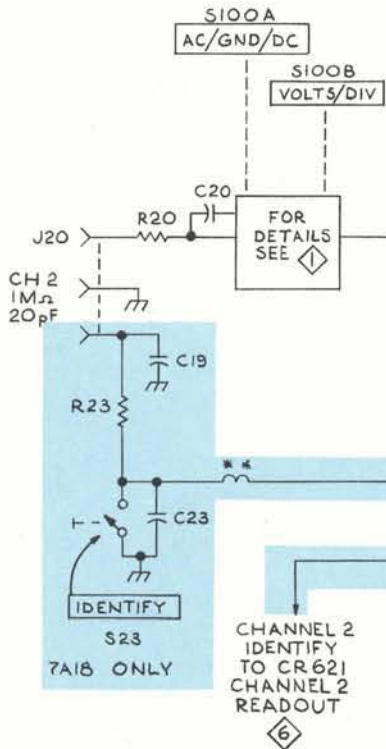
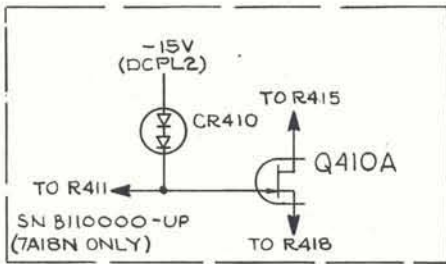

SEE PARTS LIST FOR EARLIER VALUES AND SERIAL NUMBER RANGES OF PARTS OUTLINED OR DEPICTED IN BLUE.

- * MATCHED PAIR
- ≠ 4 MATCHED TRANSISTORS
- ** T21, 2 TURN QUAD FILAR

The VOLTAGES and WAVEFORMS shown on this diagram were obtained under the conditions given on page 7-2.

P/O A2 AMPLIFIER BOARD

7A18/7A18N

REV. H, MAY 1976

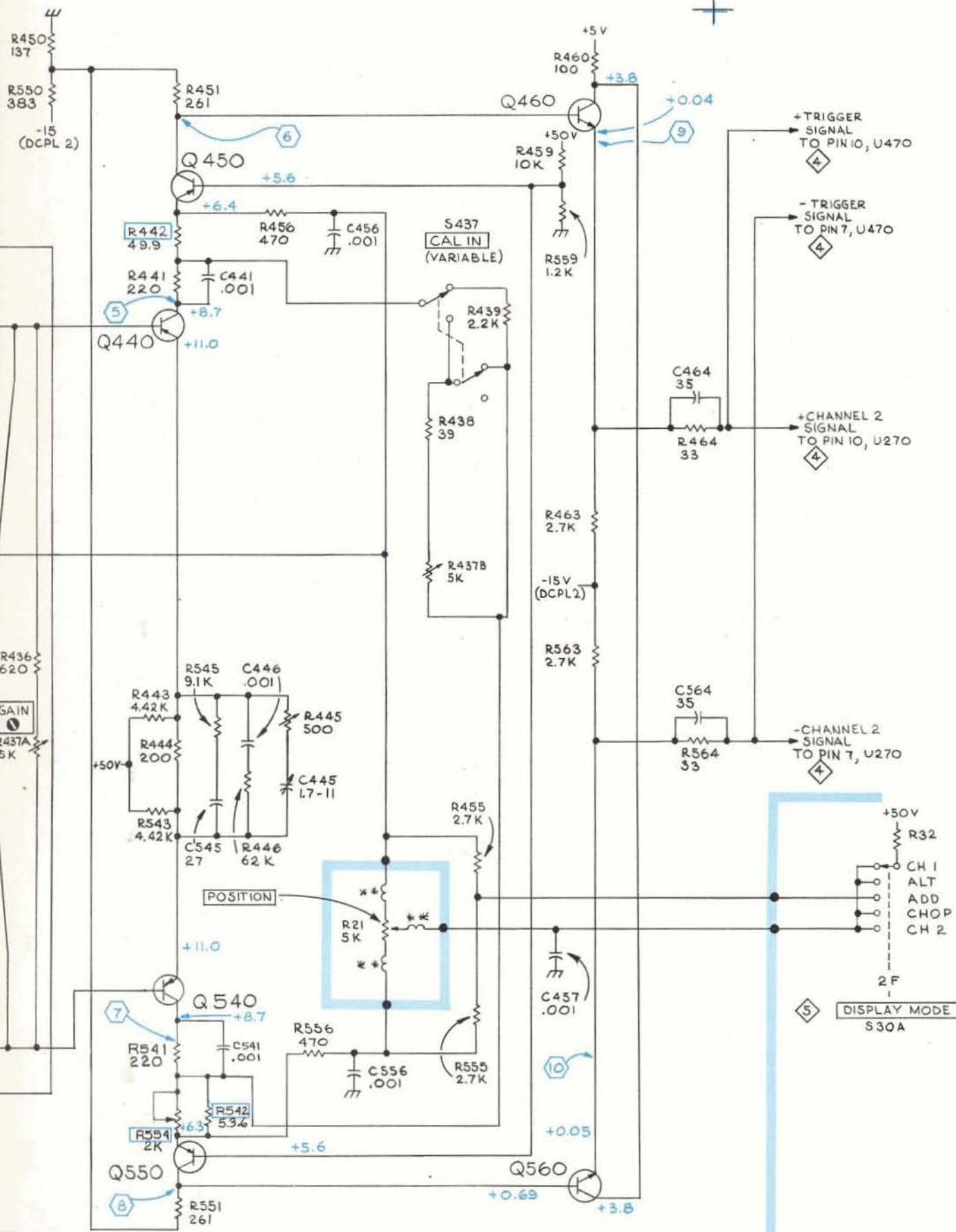

CHANNEL 2 INPUT AMPLIFIER 3
SNB060000 - UP

R.E.C.
474

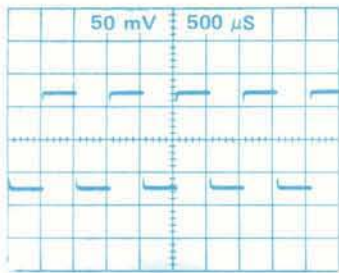

1

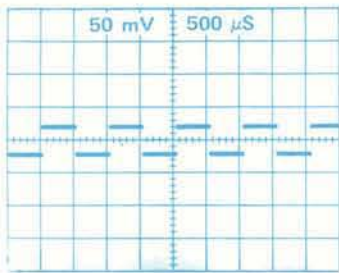

2

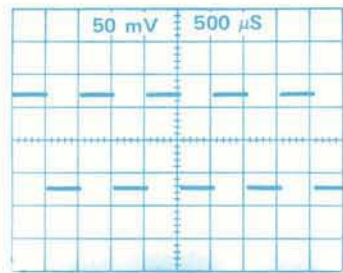

3

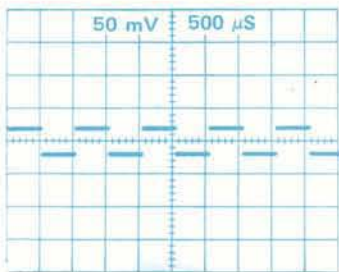

4

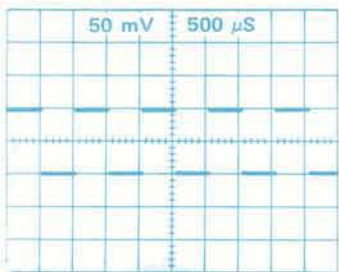

5

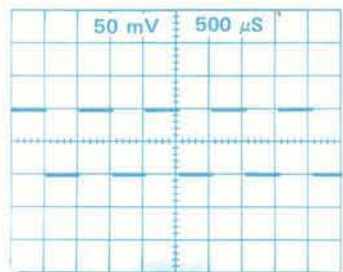

6

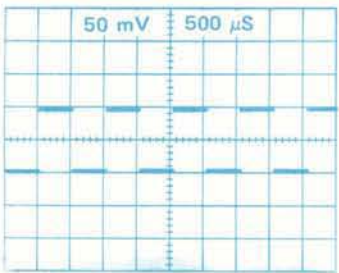

7

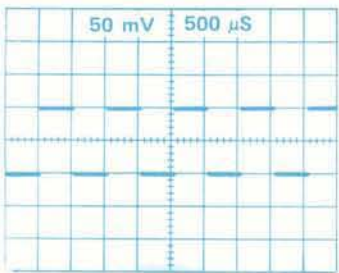

8

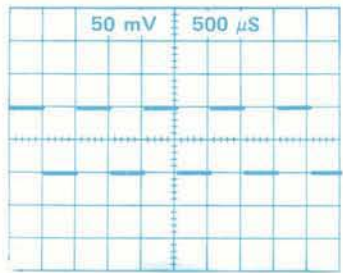

9

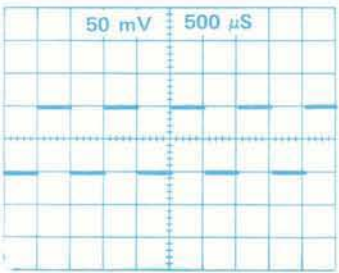

10

VOLTAGES and WAVEFORMS obtained under conditions given on page 7-2.

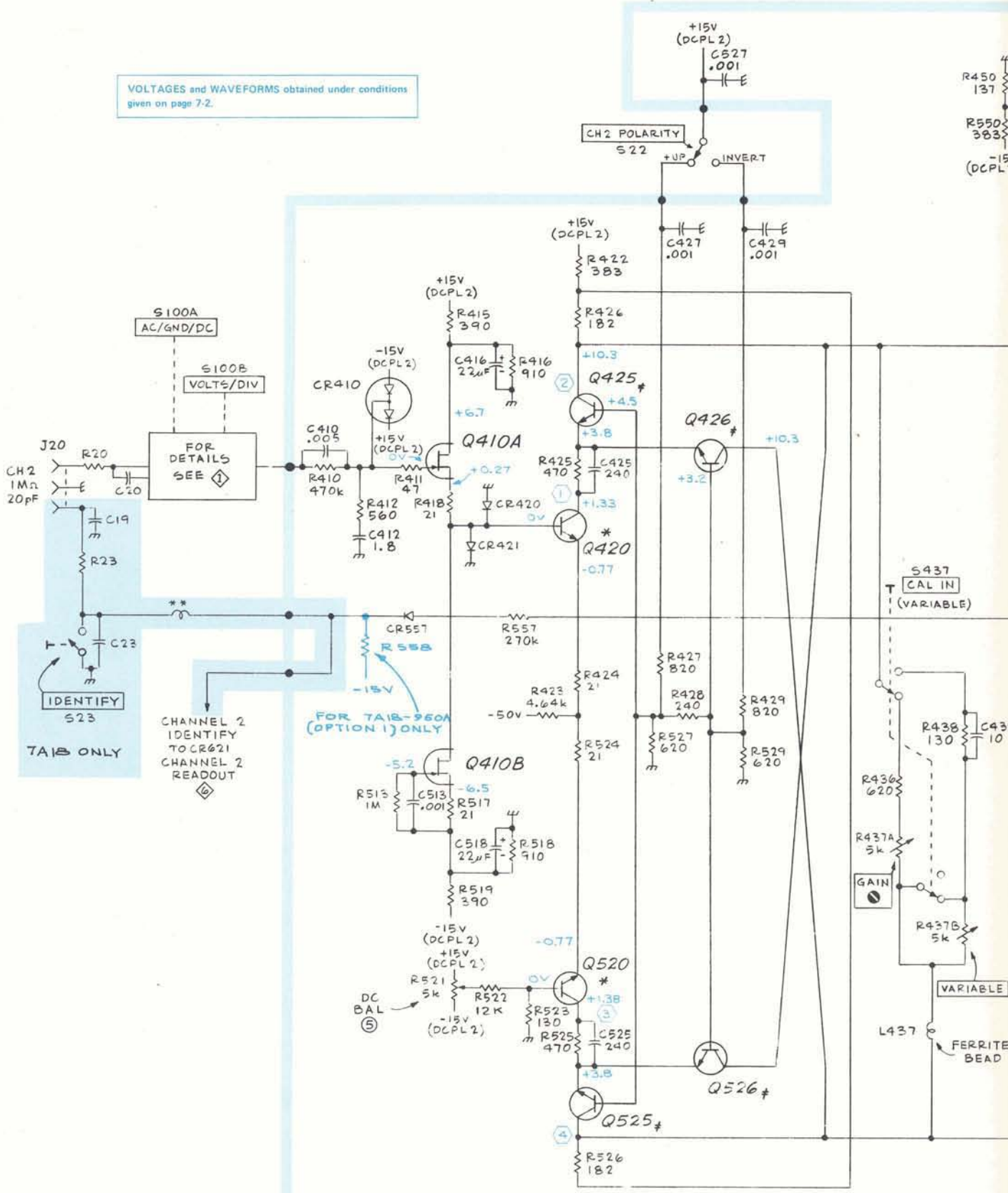

CH2
1MΩ
20pF

S100A
AC/GND/DC

S100B
VOLTS/DIV

FOR DETAILS
SEE

IDENTIFY
S23
TA1B ONLY

CHANNEL 2
IDENTIFY
TO CR621
CHANNEL 2
READOUT

FOR TA1B-950A
(OPTION 1) ONLY

DC
BAL
S5

S437
CAL IN
(VARIABLE)

GAIN
R437A
5k
R437B
5k
VARIABLE
L437
FERRITE
BEAD

- * MATCHED PAIR
- † 9 MATCHED TRANSISTORS
- ** T21, 2 TURN QUAD FILAR

P/O A2 AMPLIFIER BOARD

TA1B/TA1BN

Ⓧ

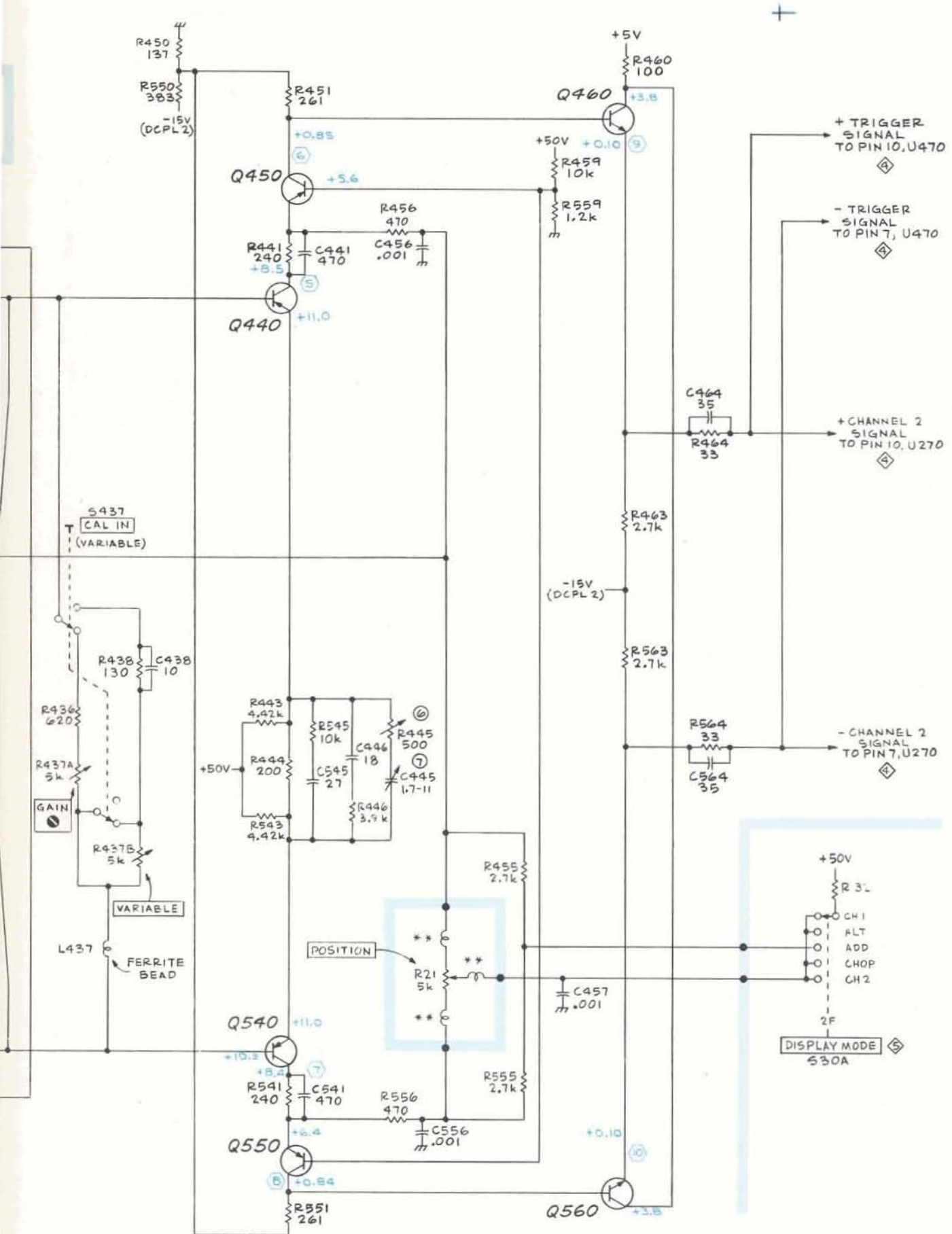

CHANNEL 2 INPUT AMPLIFIER
BELOW SNB060000

REV. APR. 1974

GAB/hq

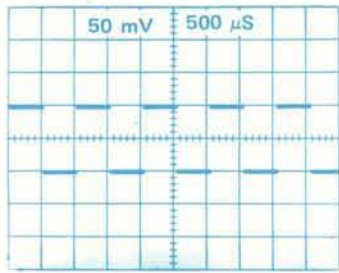

1

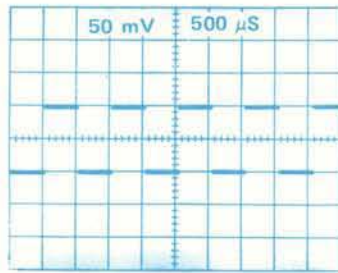

2

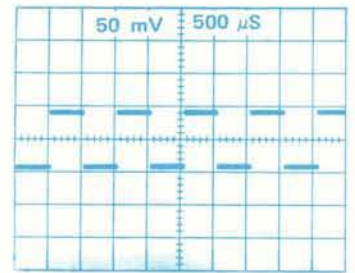

3

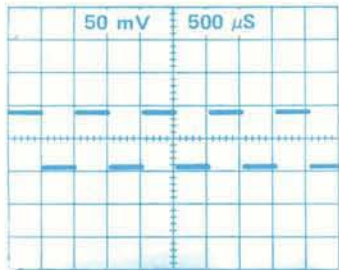

4

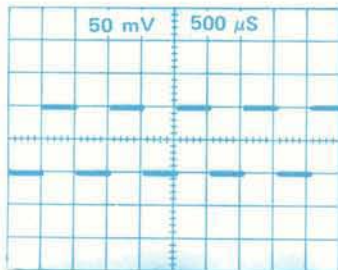

5

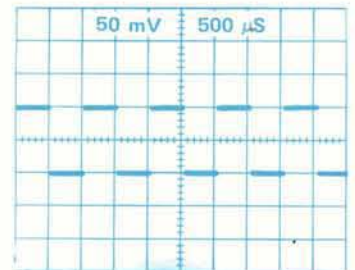

6

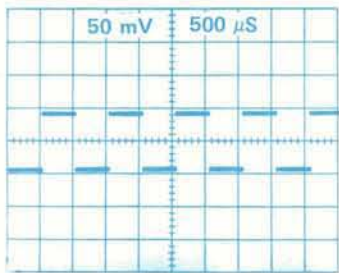

7

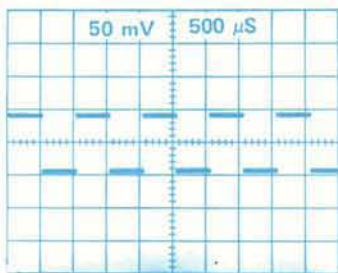

8

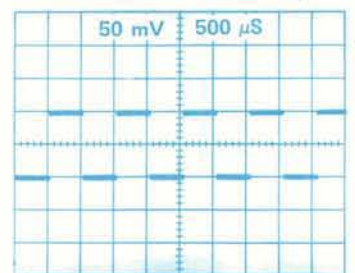

9

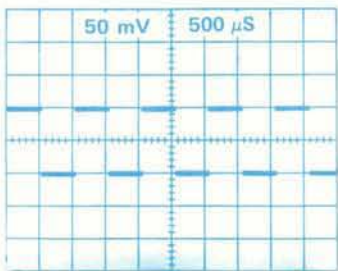

10

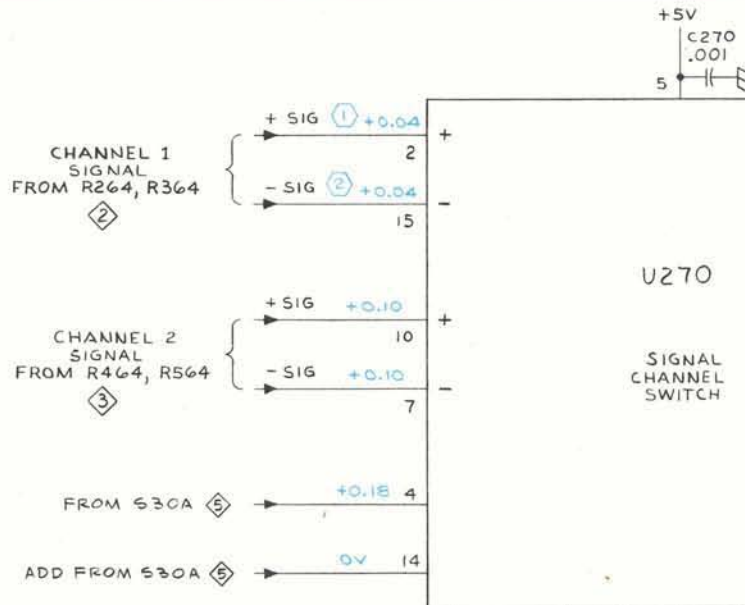

VOLTAGES and WAVEFORMS obtained under conditions given on page 7.2.

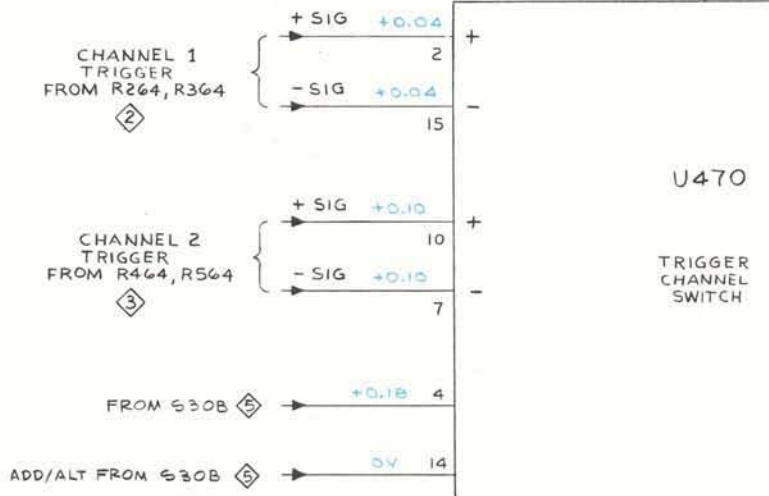
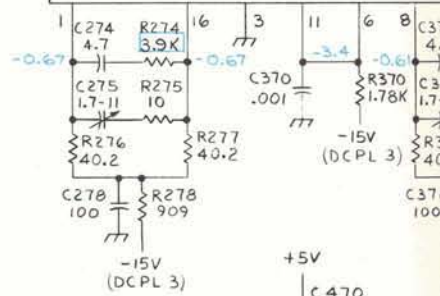

SEE PARTS LIST FOR SYMBOL VALUES AND SERIAL NUMBER RANGES OF PARTS ALLOWED WITH RUL OUTLINE

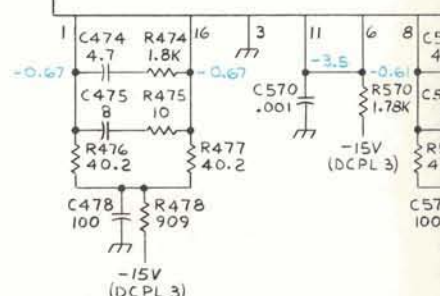

P/O A2 AMPLIFIER BOARD

7A18/7A18N

(E)

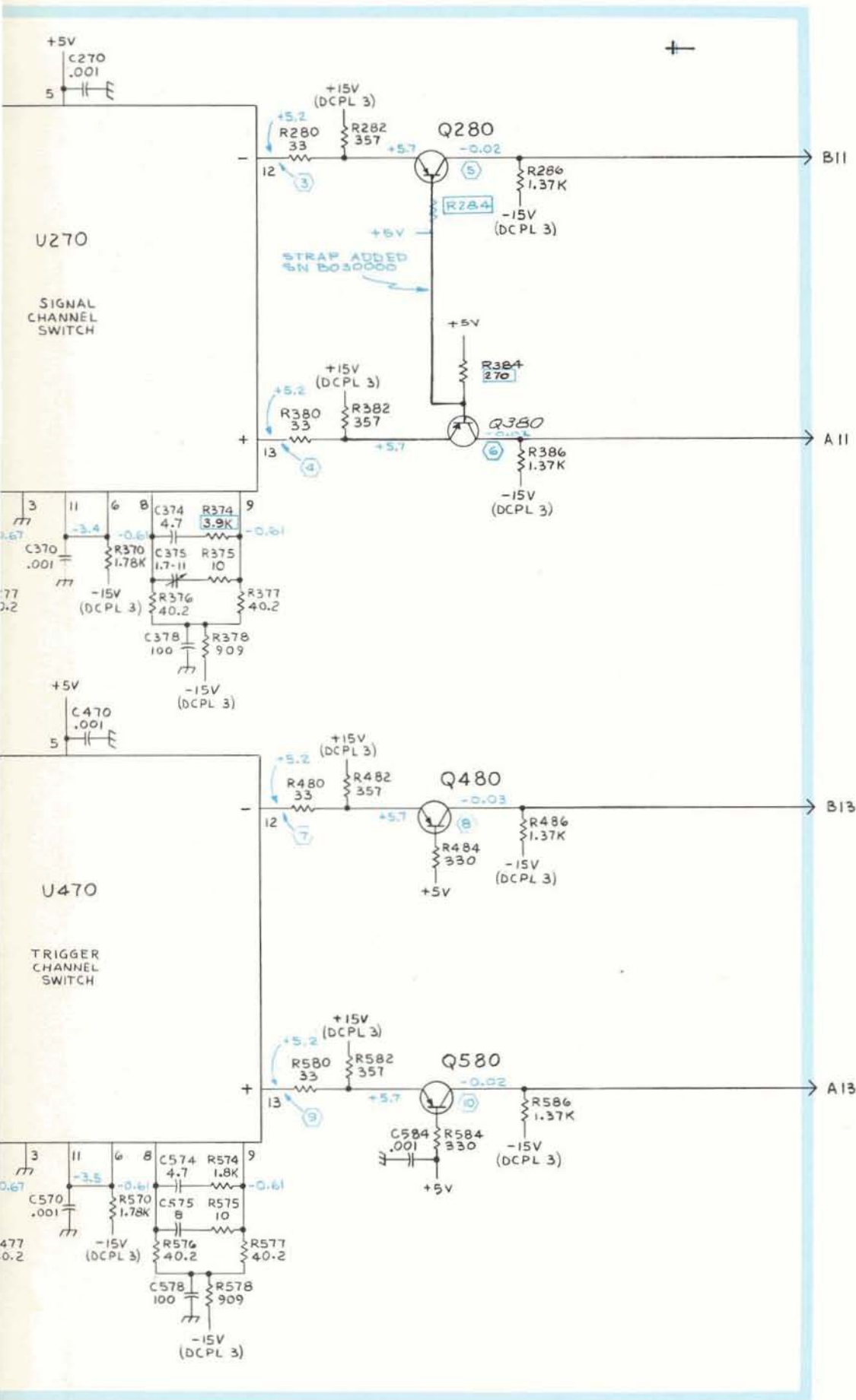

CHANNEL SWITCHES



mgf/hq

REV. APR. 1974

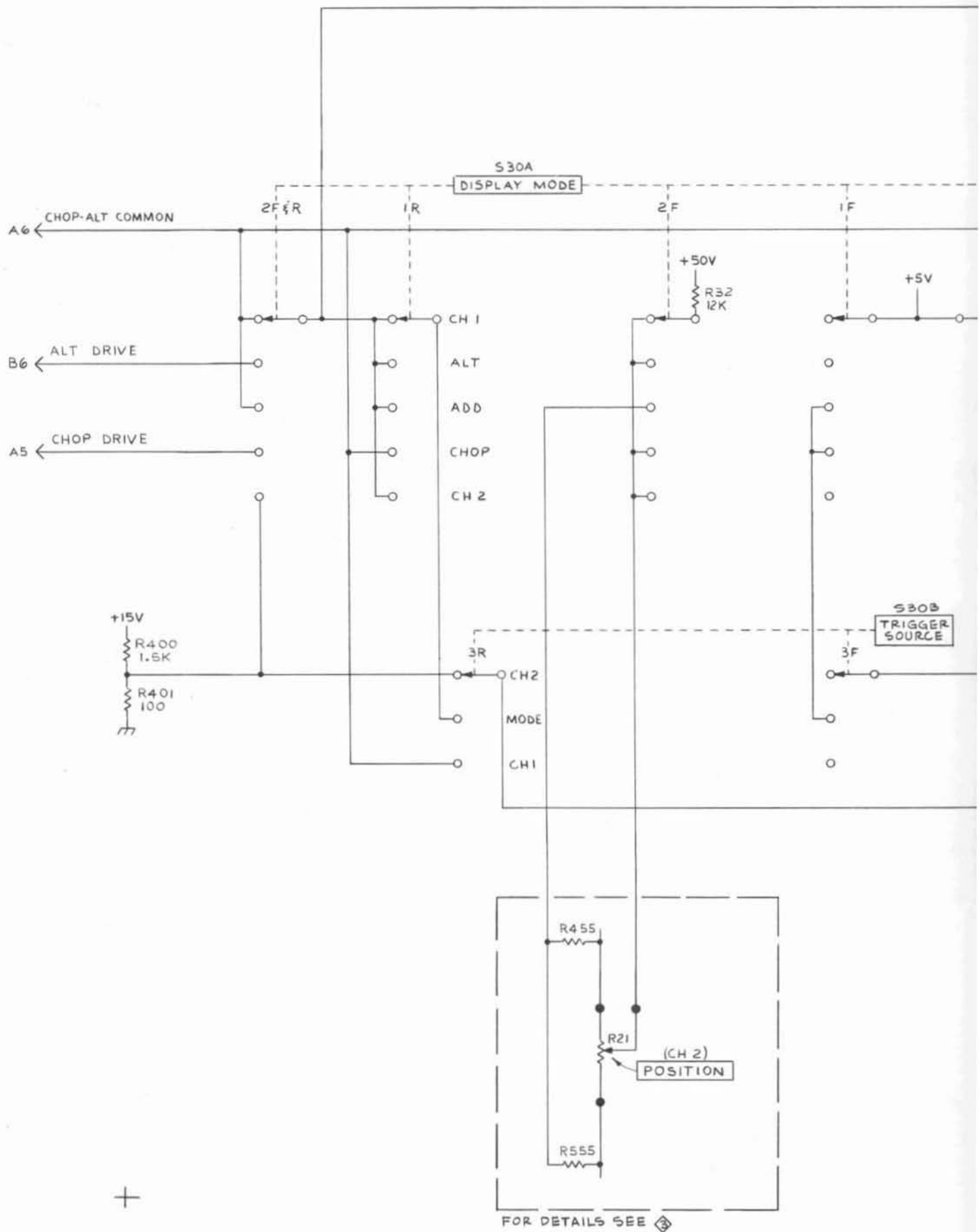

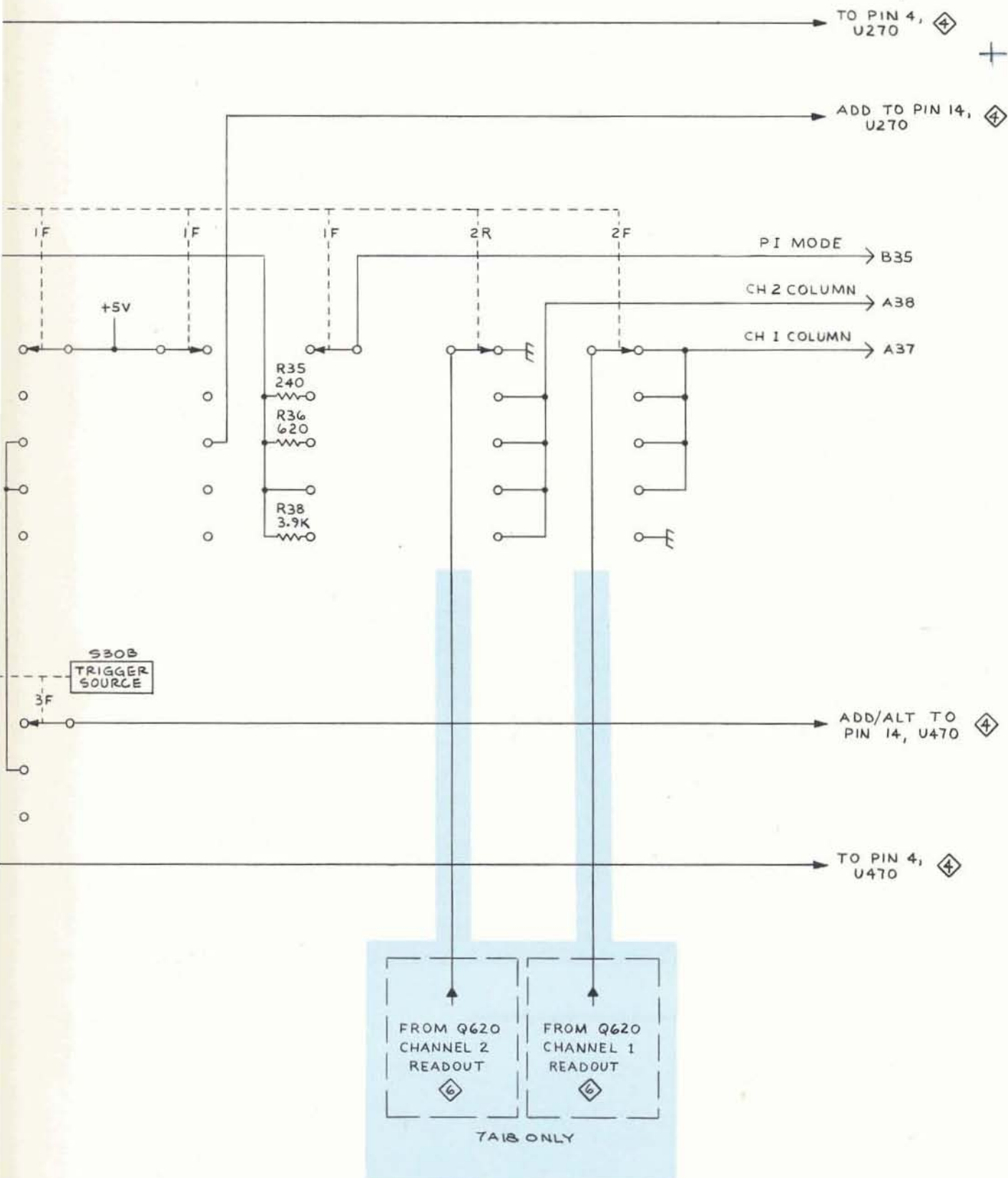

DISPLAY MODE & TRIGGER SWITCHING

5

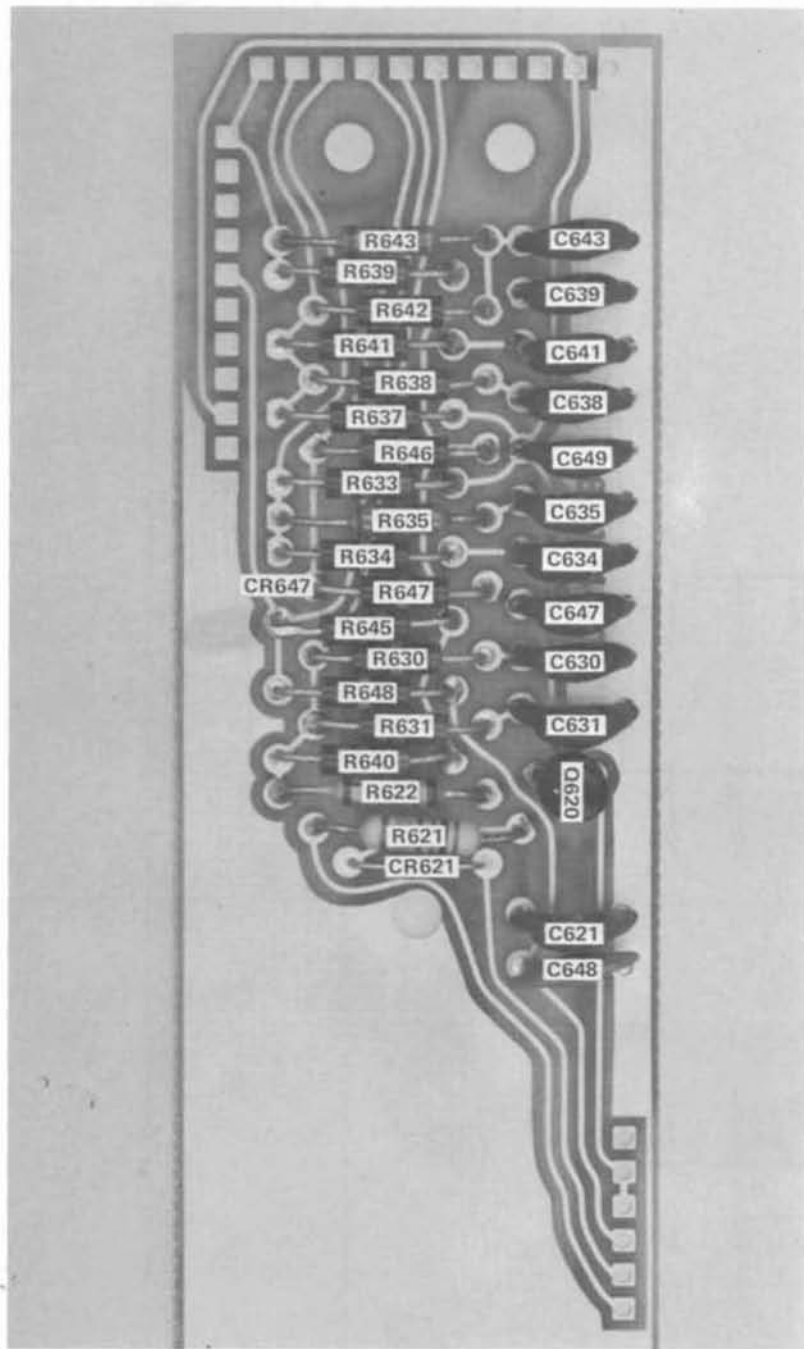
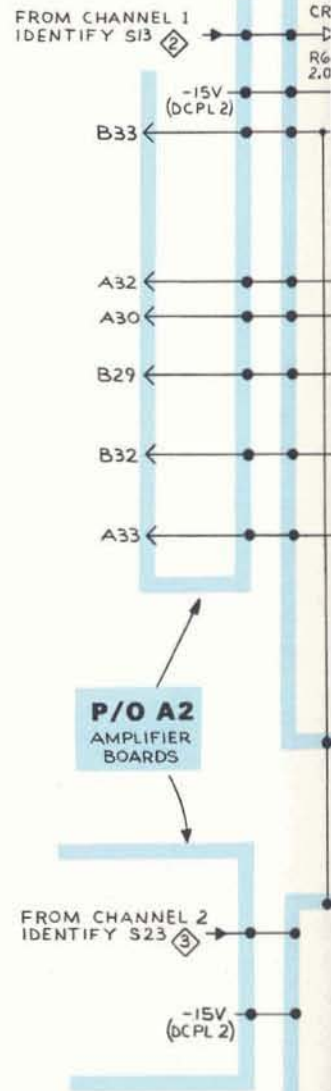
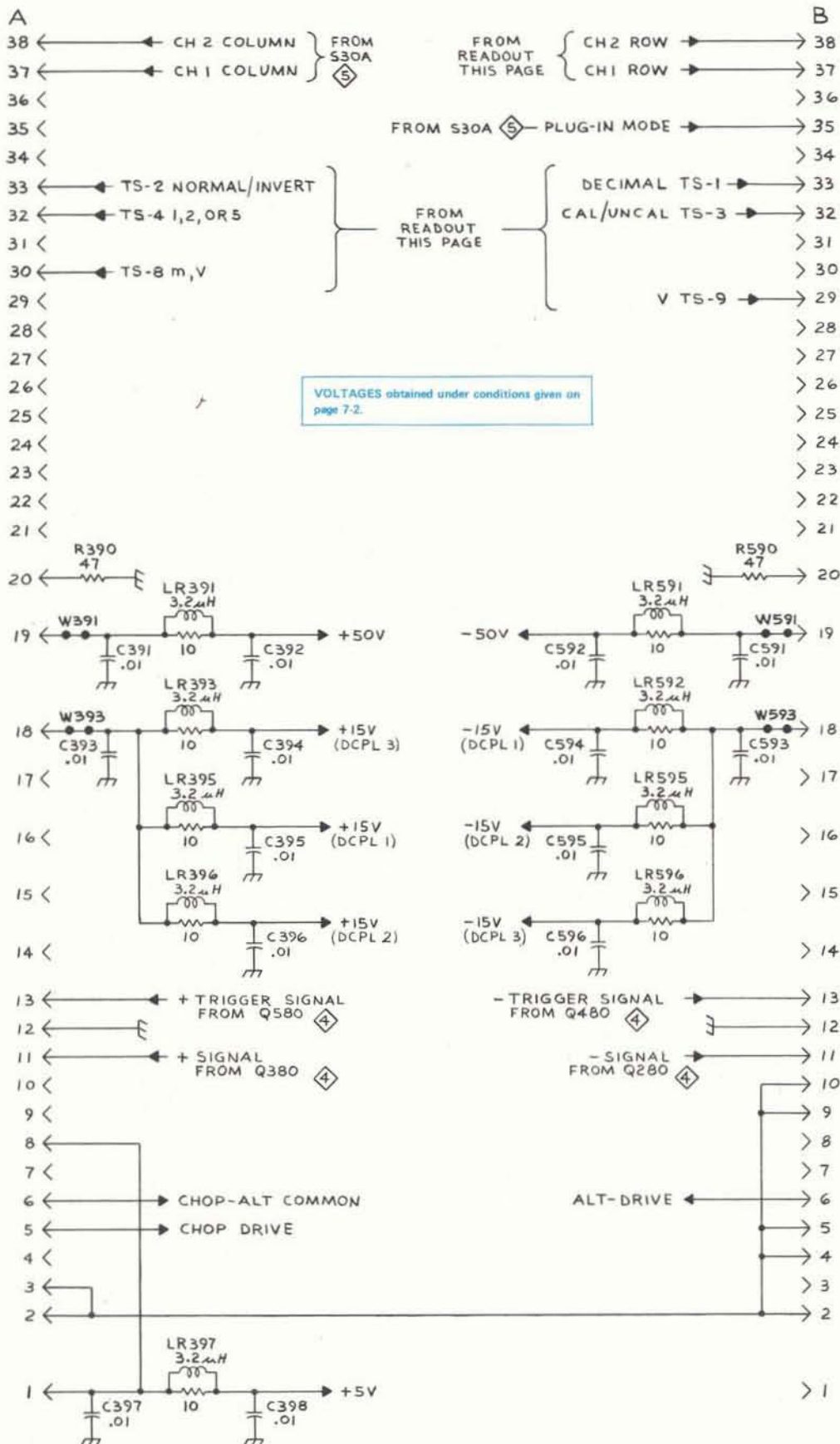
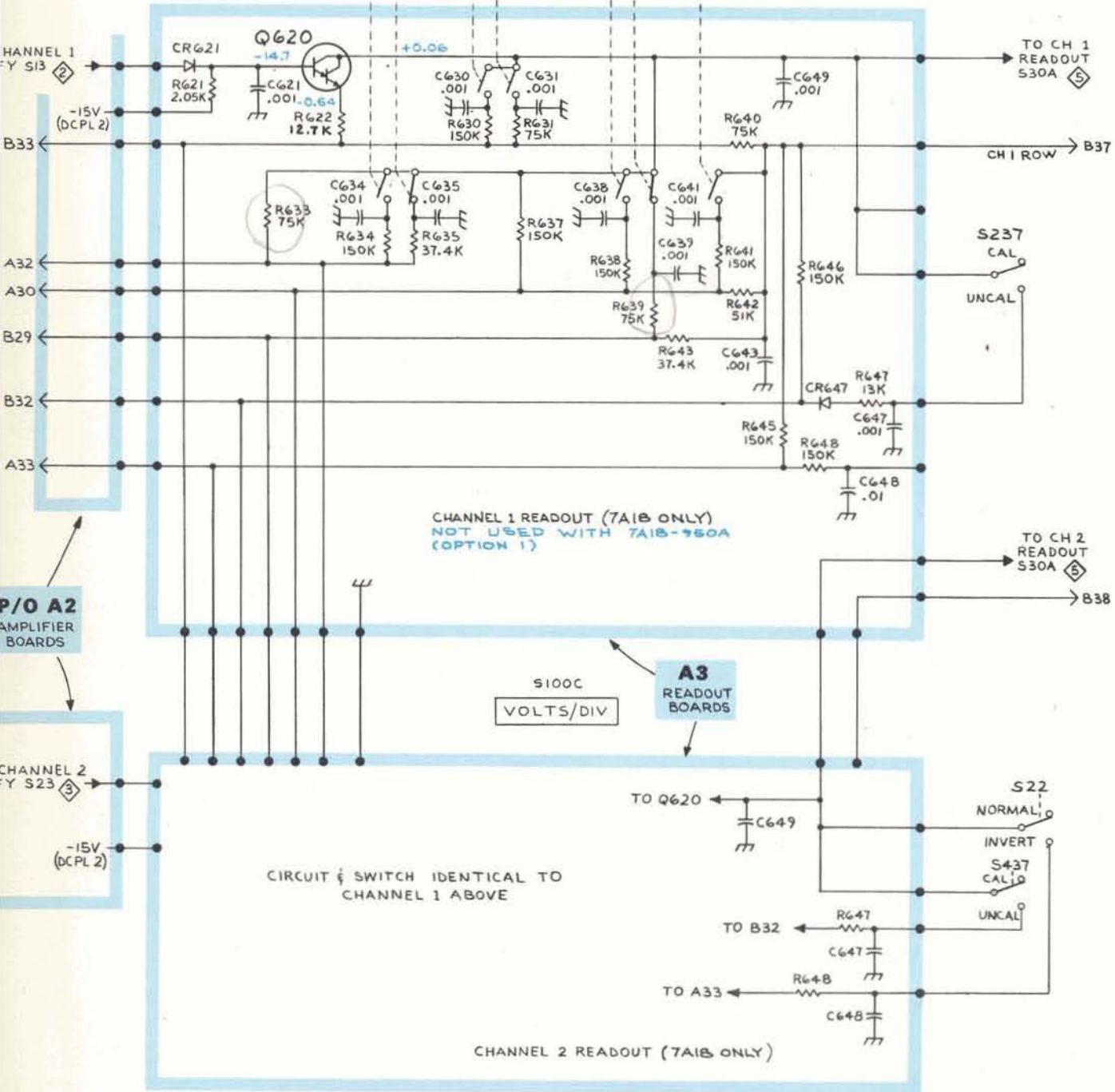
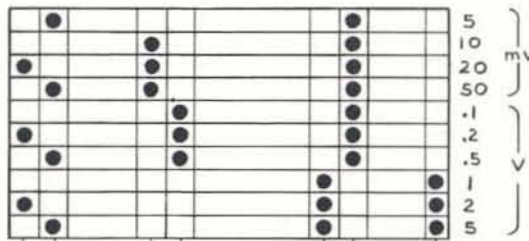

Fig. 7-3. A3 Readout Circuit Board Assembly.



S100C
VOLTS/DIV (SHOWN IN 5mv POSITION)



REPLACEABLE MECHANICAL PARTS

PARTS ORDERING INFORMATION

Replacement parts are available from or through your local Tektronix, Inc. Field Office or representative.

Changes to Tektronix instruments are sometimes made to accommodate improved components as they become available, and to give you the benefit of the latest circuit improvements developed in our engineering department. It is therefore important, when ordering parts, to include the following information in your order: Part number, instrument type or number, serial number, and modification number if applicable.

If a part you have ordered has been replaced with a new or improved part, your local Tektronix, Inc. Field Office or representative will contact you concerning any change in part number.

Change information, if any, is located at the rear of this manual.

SPECIAL NOTES AND SYMBOLS

X000 Part first added at this serial number
00X Part removed after this serial number

FIGURE AND INDEX NUMBERS

Items in this section are referenced by figure and index numbers to the illustrations.

INDENTATION SYSTEM

This mechanical parts list is indented to indicate item relationships. Following is an example of the indentation system used in the description column.

```

1 2 3 4 5           Name & Description
Assembly and/or Component
Attaching parts for Assembly and/or Component
    --- * ---
Detail Part of Assembly and/or Component
Attaching parts for Detail Part
    --- * ---
Parts of Detail Part
Attaching parts for Parts of Detail Part
    --- * ---

```

Attaching Parts always appear in the same indentation as the item it mounts, while the detail parts are indented to the right. Indented items are part of, and included with, the next higher indentation. The separation symbol --- * --- indicates the end of attaching parts.

Attaching parts must be purchased separately, unless otherwise specified.

ITEM NAME

In the Parts List, an Item Name is separated from the description by a colon (:). Because of space limitations, an Item Name may sometimes appear as incomplete. For further Item Name identification, the U.S. Federal Cataloging Handbook H6-1 can be utilized where possible.

ABBREVIATIONS

"	INCH	ELCTRN	ELECTRON	IN	INCH	SE	SINGLE END
#	NUMBER SIZE	ELEC	ELECTRICAL	INCAND	INCANDESCENT	SECT	SECTION
ACTR	ACTUATOR	ELCTLT	ELECTROLYTIC	INSUL	INSULATOR	SEMICOND	SEMICONDUCTOR
ADPTR	ADAPTER	ELEM	ELEMENT	INTL	INTERNAL	SHLD	SHIELD
ALIGN	ALIGNMENT	EPL	ELECTRICAL PARTS LIST	LPHLDR	LAMPHOLDER	SHLDR	SHOULDERED
AL	ALUMINUM	EQPT	EQUIPMENT	MACH	MACHINE	SKT	SOCKET
ASSEM	ASSEMBLED	EXT	EXTERNAL	MECH	MECHANICAL	SL	SLIDE
ASSY	ASSEMBLY	FIL	FILLISTER HEAD	MTG	MOUNTING	SLFLKG	SELF-LOCKING
ATTEN	ATTENUATOR	FLEX	FLEXIBLE	NIP	NIPPLE	SLVG	SLEEVING
AWG	AMERICAN WIRE GAGE	FLH	FLAT HEAD	NON WIRE	NOT WIRE WOUND	SPR	SPRING
BD	BOARD	FLTR	FILTER	OBD	ORDER BY DESCRIPTION	SQ	SQUARE
BRKT	BRACKET	FR	FRAME or FRONT	OD	OUTSIDE DIAMETER	SST	STAINLESS STEEL
BR	BRASS	FSTNR	FASTENER	OVH	OVAL HEAD	STL	STEEL
BRZ	BRONZE	FT	FOOT	PH BRZ	PHOSPHOR BRONZE	SW	SWITCH
BSHG	BUSHING	FXD	FIXED	PL	PLAIN or PLATE	T	TUBE
CAB	CABINET	GSKT	GASKET	PLSTC	PLASTIC	TERM	TERMINAL
CAP	CAPACITOR	HDL	HANDLE	PN	PART NUMBER	THD	THREAD
CER	CERAMIC	HEX	HEXAGON	PNH	PAN HEAD	THK	THICK
CHAS	CHASSIS	HEX HD	HEXAGONAL HEAD	PWR	POWER	TNSN	TENSION
CKT	CIRCUIT	HEX SOC	HEXAGONAL SOCKET	RCPT	RECEPTACLE	TPG	TAPPING
COMP	COMPOSITION	HLCPS	HELICAL COMPRESSION	RES	RESISTOR	TRH	TRUSS HEAD
CONN	CONNECTOR	HLEXT	HELICAL EXTENSION	RGD	RIGID	V	VOLTAGE
COV	COVER	HV	HIGH VOLTAGE	RLF	RELIEF	VAR	VARIABLE
CPLG	COUPLING	IC	INTEGRATED CIRCUIT	RTNR	RETAINER	W/	WITH
CRT	CATHODE RAY TUBE	ID	INSIDE DIAMETER	SCH	SOCKET HEAD	WSHR	WASHER
DEG	DEGREE	IDENT	IDENTIFICATION	SCOPE	OSCILLOSCOPE	XFMR	TRANSFORMER
DWR	DRAWER	IMPLR	IMPELLER	SCR	SCREW	XSTR	TRANSISTOR

CROSS INDEX MFR. CODE NUMBER TO MANUFACTURER

MFR.CODE	MANUFACTURER	ADDRESS	CITY,STATE,ZIP
0000C	GETTIG ENGINEERING AND MANUFACTURING CO.		SPRINGMILL, PA 16875
00779	AMP, INC.	P. O. BOX 3608	HARRISBURG, PA 17105
01295	TEXAS INSTRUMENTS, INC., SEMICONDUCTOR GROUP	P. O. BOX 5012	DALLAS, TX 75222
08261	SPECTRA-STRIP CORP.	7100 LAMPSON AVE.	GARDEN GROVE, CA 92642
12327	FREEWAY CORP.	9301 ALLEN DR.	CLEVELAND, OH 44125
13257	ESNA LTD.	10 ESNA PARK DR.	MARKHAM, ONTARIO, CANADA
22526	BERG ELECTRONICS, INC.	YOUK EXPRESSWAY	NEW CUMBERLAND, PA 17070
23499	GAVITT WIRE AND CABLE, DIVISION OF RSC INDUSTRIES, INC.	455 N. QUINCE ST.	ESCONDIDO, CA 92025
24931	SPECIALTY CONNECTOR CO., INC.	3560 MADISON AVE.	INDIANAPOLIS, IN 46227
36619	MICROWAVE INSTRUMENTS & COMPONENTS, INC.	6600 BOMBARDIER ST.	MONTREAL 458 QUE CAN
42838	NATIONAL RIVET AND MFG. CO.	1-21 EAST JEFFERSON ST.	WAUPUN, WI 53963
70276	ALLEN MFG. CO.	P. O. DRAWER 570	HARTFORD, CT 06101
70278	ALLIED STEEL AND CONVEYORS, DIV. OF SPARTON CORP.	17333 HEALY	DETROIT, MI 48212
70318	ALLMETAL SCREW PRODUCTS CO., INC.	821 STEWART AVE.	GARDEN CITY, NY 11530
73743	FISCHER SPECIAL MFG. CO.	446 MORGAN ST.	CINCINNATI, OH 45206
74445	HOLO-KROME CO.	31 BROOK ST. WEST	HARTFORD, CT 06110
75543	LAVELLE RUBBER CO.	424 N. WOOD	CHICAGO, IL 60622
76854	OAK INDUSTRIES, INC., SWITCH DIV.	S. MAIN ST.	CRYSTAL LAKE, IL 60014
78189	ILLINOIS TOOL WORKS, INC. SHAKEPROOF DIVISION	ST. CHARLES ROAD	ELGIN, IL 60120
79136	WALDES, KOHINOOR, INC.	47-16 AUSTEL PLACE	LONG ISLAND CITY, NY 11101
79727	C-W INDUSTRIES	550 DAVISVILLE RD.	WARMINSTER, PA 18974
80009	TEKTRONIX, INC.	P. O. BOX 500	BEAVERTON, OR 97077
83385	CENTRAL SCREW CO.	2530 CRESCENT DR.	BROADVIEW, IL 60153
83501	GAVITT WIRE AND CABLE, DIVISION OF RSC INDUSTRIES, INC.	CENTRAL ST.	BROOKFIELD, MA 01506
87308	N. L. INDUSTRIES, INC., SOUTHERN SCREW DIV.	P. O. BOX 1360	STATESVILLE, NC 28677
97464	INDUSTRIAL RETAINING RING CO.	57 CORDIER ST.	IRVINGTON, NJ 07111

Fig. & Index No.	Tektronix Part No.	Serial/Model No. Eff	Dscnt	Qty	1 2 3 4 5	Name & Description	Mfr	
							Code	Mfr Part Number
1-1	366-1163-00			1		KNOB:LIGHT GRAY	80009	366-1163-00
	213-0153-00			1		. SETSCREW:5-40 X 0.125 INCH,HEX SOC STL	74445	OBD
-2	366-1165-00			1		KNOB:GRAY	80009	366-1165-00
	213-0153-00			2		. SETSCREW:5-40 X 0.125 INCH,HEX SOC STL	74445	OBD
-3	366-1059-00			2		PUSH BUTTON:GRAY	80009	366-1059-00
-4	366-1077-00			2		KNOB:GRAY	80009	366-1077-00
	213-0153-00			1		. SETSCREW:5-40 X 0.125 INCH,HEX SOC STL	74445	OBD
-5	366-0494-00			2		KNOB:GRAY	80009	366-0494-00
	213-0153-00			1		. SETSCREW:5-40 X 0.125 INCH,HEX SOC STL	74445	OBD
-6	366-1308-00			2		KNOB:RED	80009	366-1308-00
	213-0153-00			1		. SETSCREW:5-40 X 0.125 INCH,HEX SOC STL	74445	OBD
-7	366-1299-00			2		KNOB:GRAY	80009	366-1299-00
	213-0153-00			2		. SETSCREW:5-40 X 0.125 INCH,HEX SOC STL	74445	OBD
-8	366-0215-02			2		KNOB:LEVER SWITCH	80009	366-0215-02
-9	366-1058-24			1		KNOB:LATCH	80009	366-1058-24
-10	366-1058-46			1		KNOB:LATCH	80009	366-1058-46
						(ATTACHING PARTS)		
-11	214-1095-00			1		PIN,SPG,SPLIT:0.094 OD X 0.187 INCH LONG	13257	52-022-094-0187
						- - - * - - -		
-12	105-0076-00			1		REL BAR,LATCH:PLUG-IN UNIT	80009	105-0076-00
-13	214-1280-00			1		SPRING,HLCPS:0.14 OD X 1.126"L,0.16"DIA W	80009	214-1280-00
-14	214-1054-00			1		SPRING,DETENT:LATCH	80009	214-1054-00
-15	105-0075-00			1		PAWL:0.475 X 0.21 X 0.184 INCH,PLSTC	80009	105-0075-00
-16	348-0235-00			2		SHLD GSKT,ELEC:4.734 INCH LONG	80009	348-0235-00
-17	333-1411-00			1		PANEL,FRONT:	80009	333-1411-00
-18	333-1596-00			1		PANEL,FRONT:	80009	333-1596-00
-19	337-1064-00	B010100	B029999	2		SHLD,SIDE,ELEC:PLUG-IN	80009	337-1064-00
	337-1064-04	B030000		2		SHIELD,ELEC:RIGHT SIDE	80009	337-1064-00
-20	131-0679-00	B010100	B020099X	2		CONNECTOR,RCPT,:BNC W/HARDWARE	24931	28JR168-1
-21	131-0126-00			2		CONNECTOR,RCPT,:BNC,FEMALE	36619	9663-1 NT-34
						(ATTACHING PARTS)		
-22	220-0569-00	B010100	B020099X	1		NUT,PLAIN,KNURL:0.50-28 X 0.235 INCH BRS	80009	220-0569-00
						- - - * - - -		
-23	358-0216-00			1		BUSHING,PLASTIC:0.257 ID X 0.412 INCH OD	80009	358-0216-00
-24	-----			2		RESISTOR,VARIABLE		
-25	-----			2		RESISTOR,VARIABLE:W/HARDWARE		
						(ATTACHING PARTS)		
-26	210-0583-00			1		NUT,PLAIN,HEX.:0.25-32 X 0.312 INCH,BRS	73743	2X20224-402
-27	210-0011-00			1		WASHER,LOCK:INTL,0.062 ID X 0.253 OD,STL	78189	1214-00-00-0541C
						- - - * - - -		
-28	260-0816-00			1		SWITCH,SLIDE:DPDT,0.5A,125VAC	79727	GF-126-0012A
						(ATTACHING PARTS)		
-29	211-0030-00			2		SCREW,MACHINE:2-56 X 0.25"82 DEG,FLH STL	83385	OBD
-30	210-0405-00			2		NUT,PLAIN,HEX.:2-56 X 0.188 INCH,BRS	73743	2X12157-402
						- - - * - - -		
-31	386-1447-54			1		SUBPANEL,FRONT:	80009	386-1447-54
						(ATTACHING PARTS)		
-32	213-0192-00			4		SCR,TPG,THD FOR:6-32 X 0.50 INCH,PNH STL	87308	OBD
						- - - * - - -		
-33	-----			3		CKT BOARD ASSY:AMPLIFIER (SEE A2 EPL)		
-34	136-0252-04	B010100	B054199	88		. CONTACT,ELEC:0.188 INCH LONG	22526	75060
	136-0252-04	B054200		10		. CONTACT,ELEC:0.188 INCH LONG	22526	75060
	136-0350-00	B054200		26		. SOCKET,PLUG-IN:3 PIN,LOW PROFILE	80009	136-0350-00
-35	131-0566-00			4		. LINK,TERM.CONNE:0.086 DIA X 2.375 INCH L	0000C	L-2007-1
-36	200-0945-00			4		. COVER,HALF XSTR:FOR DUAL TO-18 CASE	80009	200-0945-00
-37	200-0945-01			4		. COVER,HALF XSTR:FOR DUAL TO-18 CS,2-56 THD	80009	200-0945-01
-38	211-0001-00			4		. SCREW,MACHINE:2-56 X 0.25 INCH,PNH STL	83385	OBD
-39	136-0260-02			2		. SOCKET,PLUG-IN:16 CONTACT,LOW CLEARANCE	01295	C931602
-40	124-0162-00			2		. TERMINAL BOARD:4 NOTCH	80009	124-0162-00
-41	355-0046-00			1		. MOUNT,TERM. BD:0.577 INCH H	80009	355-0046-00
-42	262-0928-00			2		. SWITCH,PUSH:GAIN (CH1,CH2,WIRED)	80009	262-0928-00
						(ATTACHING PARTS)		
-43	210-0583-00			1		. NUT,PLAIN,HEX.:0.25-32 X 0.312 INCH,BRS	73743	2X20224-402
-44	210-0046-00			1		. WASHER,LOCK:INTL,0.26 ID X 0.40" OD,STL	78189	1214-05-00-0541C
						- - - * - - -		

17A18 only.
 27A18N only.
 3Refer to Electrical Parts List for part number.

Mechanical Parts List—7A18/7A18N

Fig. & Index No.	Tektronix Part No.	Serial/Model No. Eff	Dscont	Qty	1	2	3	4	5	Name & Description	Mfr Code	Mfr Part Number
1-45	262-0926-00			1	.					SWITCH, ROTARY: TRIG SOURCE/DISP MODE (WIRED)	80009	262-0926-00
	260-1221-00			1	.					SWITCH, ROTARY:	76854	5-41981-411
-46	175-0825-00			FT	.					WIRE, ELECTRICAL: 0.833 FT 2 WIRE RIBBON	23499	TEK-175-0825-00
-47	175-0828-00			FT	.					WIRE, ELECTRICAL: 2.833 FT 5 WIRE RIBBON	23499	TEK-175-0828-00
-48	175-0830-00			FT	.					WIRE, ELECTRICAL: 7 WIRE RIBBON (ATTACHING PARTS)	08261	TEK-175-0830-00
-49	210-0590-00			1	.					NUT, PLAIN, HEX.: 0.375 X 0.438 INCH, STL	73743	2X28269-402
-50	210-0012-00			1	.					WASHER, LOCK: INTL, 0.375 ID X 0.50" OD STL - - - * - - -	78189	1220-02-00-0541C
-51	407-0553-00			2	.					BRKT, CMPNT MTG:	80009	407-0553-00
-52	407-0912-00			1	.					BRKT, CMPNT MTG:	80009	407-0912-00
-53	376-0039-00	B010100	B029999	2	.					ADPT, SHAFT, CPLG: 0.128 AND 0.082" DIA SHAFT	80009	376-0039-00
	376-0152-00 ¹	B030000		2	.					COUPLING SHAFT:	80009	376-0152-00
	213-0075-00			2	.					SETSCREW: 4-40 X 0.094 INCH, HEX SOC STL	70276	OBD
-54	376-0125-00			2	.					COUPLER, SWITCH: (ATTACHING PARTS)	80009	376-0125-00
	213-0048-00	B010100	B065219	2	.					SETSCREW: 4-40 X 0.125 INCH, HEX SOC STL	74445	OBD
	213-0022-00	B065220		2	.					SETSCREW: 4-40 X 0.188 INCH, HEX SOC STL	74445	OBD
	354-0251-00			1	.					RING, COUPLING: 0.251 ID X 0.375 INCH OD, AL - - - * - - -	80009	354-0251-00
-55	376-0124-00			2	.					COUPLER, SWITCH: (ATTACHING PARTS)	80009	376-0124-00
	213-0048-00			2	.					SETSCREW: 4-40 X 0.125 INCH, HEX SOC STL	74445	OBD
	354-0251-00			1	.					RING, COUPLING: 0.251 ID X 0.375 INCH OD, AL (ATTACHING PARTS FOR CKT BD ASSY)	80009	354-0251-00
-56	211-0116-00			4	SCR, ASSEM WSHR: 4-40 X 0.312 INCH, PNH BRS						83385	OBD
-57	211-0105-00			4	SCREW, MACHINE: 4-40 X 0.188" 100 DEG, FLH STL						83385	OBD
-58	220-0547-01			4	NUT, BLOCK: 0.38 X 0.25 X 0.282" OA						80009	220-0547-01
-59	200-1199-00			2	COVER, ATTN.:						80009	200-1199-00
-60	211-0007-00			4	SCREW, MACHINE: 4-40 X 0.188 INCH, PNH STL						83385	OBD
-61	210-0994-00			4	WASHER, FLAT: 0.125 ID X 0.25" OD, STL - - - * - - -						83385	OBD
	210-1093-00 ²	XB053390		2	WASHER, PLASTIC: 0.187 ID X 0.312 INCH OD						75543	OBD
-62	131-1075-00			1	CONTACT, ELEC: GROUNDING						80009	131-1075-00
-63	210-0288-00			2	TERMINAL, LUG: 0.125 ID X 1.125 INCH LONG (ATTACHING PARTS FOR EACH)						80009	210-0288-00
-64	210-0586-00			1	NUT, PLAIN, EXT W: 4-40 X 0.25 INCH, STL						78189	OBD
-65	211-0101-00			1	SCREW, MACHINE: 4-40 X 0.25" 100 DEG, FLH STL - - - * - - -						83385	OBD
-66	407-0906-00			1	BRACKET: CIRCUIT BOARD (ATTACHING PARTS)						80009	407-0906-00
-67	211-0116-00			2	SCR, ASSEM WSHR: 4-40 X 0.312 INCH, PNH BRS						83385	OBD
-68	210-0586-00			2	NUT, PLAIN, EXT W: 4-40 X 0.25 INCH, STL - - - * - - -						78189	OBD
-69	337-1423-00			2	SHIELD, ELEC: ATTENUATOR, FRONT (ATTACHING PARTS FOR EACH)						80009	337-1423-00
-70	213-0055-00			1	SCR, TPG, THD FOR: 2-32 X 0.188 INCH, PNH STL - - - * - - -						83385	OBD
	672-0020-00 ³	B010100	B049999	2	CKT BOARD ASSY: ATTENUATOR/READOUT						80009	672-0020-00
	672-0020-01 ³	B050000	B099999	2	CKT BOARD ASSY: ATTENUATOR/READOUT						80009	672-0020-01
	672-0020-02 ³	B100000		2	CKT BOARD ASSY: ATTENUATOR/READOUT						80009	672-0020-02
	672-0480-00 ⁴			2	CKT BOARD ASSY: ATTENUATOR (2)						80009	670-0480-00
-71	200-1277-00			1	COVER: CAM SWITCH (ATTACHING PARTS)						80009	200-1277-00
-72	211-0116-00			6	SCR, ASSEM WSHR: 4-40 X 0.312 INCH, PNH BRS - - - * - - -						83385	OBD
-73	----- ³			1	CKT BOARD ASSY: READOUT (SEE A3 EPL)							
-74	136-0252-04 ³			3	CONTACT, ELEC: 0.188 INCH LONG						22526	75060
	136-0252-01 ³	XB100000		8	CONTACT, ELEC: 0.178 INCH LONG						00779	1-332095-2
-75	210-0799-00 ³	B010100	B099999	7	EYELET, METALLIC: 0.295 OD X 0.362 INCH L						80009	210-0799-00
	210-0779-00 ³	B100000		8	RIVET, TUBULAR: 0.051 OD X 0.115 INCH LONG						42838	RA-29952715
-76	131-1031-00 ³	B010100	B099999	7	CONTACT ASSY, EL: CAM SWITCH, TOP						80009	131-1031-00

¹Serial number break is for 7A18N. Serial number break for 7A18 is B440000. XB066940

²Serial number break is for 7A18N. Serial number break for 7A18 is XB066940.

³7A18 only.

⁴7A18N only.

Fig. & Index No.	Tektronix Part No.	Serial/Model No. Eff	Dscont	Qty	1 2 3 4 5	Name & Description	Mfr	
							Code	Mfr Part Number
1-	131-1031-00	B100000		8	.	CONTACT ASSY, EL:CAM SWITCH, TOP (ATTACHING PARTS FOR CKT BD ASSY)	80009	131-1031-00
-77	211-0116-00 ¹			6	.	SCR, ASSEM WSHR:4-40 X 0.312 INCH, PNH BRS - - - * - - -	83385	OBD
-78	337-1418-01 ¹			2	.	SHIELD, ELEC:CAM SWITCH (ATTACHING PARTS FOR EACH)	80009	337-1418-01
-79	213-0277-00 ¹	B010100	B110474	3	.	SCR, TPG, THD FOR:2-56 X 0.312 INCH, PNH STL	83385	OBD
	211-0001-00 ¹	B110475		3	.	SCREW, MACHINE:2-56 X 0.25 INCH, PNH STL - - - * - - -	83385	OBD
	263-1105-00	XB100000		1	.	ACTUATOR ASSY:ATTENUATOR SWITCH (ATTACHING PARTS)	80009	263-1105-00
-80	105-0243-00			1	.	ACTUATOR, SWITCH:	80009	105-0243-00
	213-0214-00			1	.	SCREW, CAP SCH:2-56 X 0.375"HEX HD STL - - - * - - -	70278	OBD
-81	354-0391-00	B010100	B049999	2	.	RING, RETAINING:0.395"FREE ID X 0.025" STL	97464	3100-43-CD
	354-0390-00 ²	B050000		1	.	RING, RETAINING:0.338 ID X 0.025" THK, STL	79136	5100-37MD
	354-0443-00 ²	B050000		1	.	RING, RETAINING:0.328 FREE ID X 0.448 OD	97464	200-37
-82	401-0081-02	B010100	B049999	2	.	BEARING, CAM SW:FRONT	80009	401-0081-02
	401-0180-00 ²	B050000		2	.	BEARING, CAM SW:FRONT	80009	401-0180-00
	210-0406-00			10	.	NUT, PLAIN, HEX.:4-40 X 0.188 INCH, BRS	73743	2X12161-402
-83	214-1139-00 ³			-	.	SPRING, FLAT:GOLD COLORED	80009	214-1139-00
	214-1139-02 ³			-	.	SPRING, FLAT:GREEN COLORED GREEN COLORED	80009	214-1139-02
	214-1139-03 ³			-	.	SPRING, FLAT:RED COLORED RED COLORED	80009	214-1139-03
-84	105-0242-00	B010100	B049999	1	.	DRUM CAM SWITCH:AC GND DC	80009	105-0242-00
	105-0242-01 ²	B050000		1	.	DRUM CAM SWITCH:AC GND DC	80009	105-0242-01
-85	105-0241-00	B010100	B049999	1	.	DRUM CAM SWITCH:VOLTS/DIV	80009	105-0241-00
	105-0241-01 ²	B050000		1	.	DRUM CAM SWITCH:VOLTS/DIV	80009	105-0241-01
	384-0878-01 ²	XB050000		1	.	SHAFT, CAM SW:FRONT	80009	384-0878-01
	384-0880-01 ²	XB050000		1	.	SHAFT:INTERMEDIATE	80009	384-0880-01
-86	401-0115-00	B010100	B049999	1	.	BEARING, CAM SW:CENTER	80009	401-0115-00
	401-0178-00 ²	B050000		1	.	BEARING, CAM SW:CENTER/REAR	80009	401-0178-00
-87	441-0992-00	B010100	B010100	1	.	CHASSIS:	80009	441-0992-00
	441-0992-04 ²	B020000		1	.	CHASSIS: (ATTACHING PARTS)	80009	441-0992-04
	210-0405-00	XB020000		3	.	NUT, PLAIN, HEX.:2-56 X 0.188 INCH, BRS	73743	2X12157-402
-88	211-0097-00			3	.	SCREW, MACHINE:4-40 X 0.312 INCH, PNH STL	83385	OBD
-89	210-0004-00			2	.	WASHER, LOCK:INTL, 0.12 ID X 0.26"OD, STL - - - * - - -	78189	1204-00-00-0541C
-90	129-0299-00			4	.	POST, ELEC-MECH:HEX, 0.333 INCH LONG (ATTACHING PARTS FOR EACH)	80009	129-0299-00
-91	210-0004-00			1	.	WASHER, LOCK:INTL, 0.12 ID X 0.26"OD, STL - - - * - - -	78189	1204-00-00-0541C
-92	214-1127-00	B010100	B049999	4	.	ROLLER, DETENT:0.125 DIA X 0.125 INCH L	80009	214-1127-00
	214-1752-00 ²	B050000		4	.	ROLLER, DETENT:	80009	214-1752-00
-93	210-0591-00			10	.	NUT, HEX:4-40 X 0.188 INCH	70318	OBD
-94	337-1406-00			1	.	SHLD, ELECTRICAL:CAM CONTACTS	80009	337-1406-00
-95	136-0252-01			8	.	CONTACT, ELEC:0.178 INCH LONG	00779	1-332095-2
-96	210-0779-00			10	.	RIVET, TUBULAR:0.051 OD X 0.115 INCH LONG	42838	RA-29952715
-97	131-1031-00			10	.	CONTACT ASSY, EL:CAM SWITCH, TOP	80009	131-1031-00
-98	131-1030-00			10	.	CONTACT ASSY, EL:CAM SWITCH, BOTTOM	80009	131-1030-00
-99	----- ⁴			1	.	CKT BOARD ASSY:ATTENUATOR (SEE A1 EPL) (ATTACHING PARTS)		
-100	213-0120-00			3	.	SCR, TPG, THD FOR:2-32 X 0.250 INCH, PNH STL	83385	OBD
-101	210-0053-00			3	.	WASHER, LOCK:INTL, 0.092 ID X 0.175"OD, STL	83385	OBD
-102	210-1134-00			3	.	WASHER, FLAT:0.09 ID X 0.25 INCH OD, BRS	12327	OBD
	210-0405-00			3	.	NUT, PLAIN, HEX.:2-56 X 0.188 INCH, BRS (ATTACHING PARTS FOR CKT BDS)	73743	2X12157-402
-103	211-0008-00 ¹			2	.	SCREW, MACHINE:4-40 X 0.25 INCH, PNH STL	83385	OBD
-104	129-0080-01 ¹			1	.	POST:4-40 X 0.875 INCH LONG - - - * - - -	80009	129-0080-01
-105	386-1402-00			1	.	PANEL, REAR: (ATTACHING PARTS)	80009	386-1402-00
-106	213-0192-00			4	.	SCR, TPG, THD FOR:6-32 X 0.50 INCH, PNH STL	87308	OBD
-107	361-0326-00			1	.	SPACER, SLEEVE:0.18 ID X 0.25 OD X 0.10"L - - - * - - -	80009	361-0326-00

¹7A18 only.

²Serial number break is for 7A18N only. Serial number for 7A18 is B060000.

³Replace with part bearing the same color code as the original in your instrument.

⁴7A18N only.

Mechanical Parts List—7A18/7A18N

Fig. & Index No.	Tektronix Part No.	Serial/Model No. Eff	Dscont	Qty	Name & Description					Mfr		
					1	2	3	4	5	Code	Mfr Part Number	
1-108	426-0737-00			1						FR SECT, PLUG-IN: BOTTOM	80009	426-0737-00
-109	426-0736-00			1						FR SECT, PLUG-IN: TOP	80009	426-0736-00
-110	214-1061-00			1						SPRING, GROUND: FLAT	80009	214-1061-00
-111	384-1078-00			2						EXTENSION SHAFT: 0.124 OD X 6.843 INCH LONG	80009	384-1078-00
-112	175-0825-00			FT						WIRE, ELECTRICAL: 0.833 FT 2 WIRE RIBBON	23499	TEK-175-0825-00
-113	175-0826-00			FT						WIRE, ELECTRICAL: 3 WIRE RIBBON	08261	TEK-175-0826-00
	175-0826-00 ¹			FT						WIRE, ELECTRICAL: 3 WIRE RIBBON	08261	TEK-175-0826-00
-114	175-0827-00 ²			FT						WIRE, ELECTRICAL: 4 WIRE RIBBON	08261	TEK-175-0827-00
-115	175-0828-00			FT						WIRE, ELECTRICAL: 2.833 FT 5 WIRE RIBBON	23499	TEK-175-0828-00
-116	175-0829-00			FT						WIRE, ELECTRICAL: 0.585 FT 6 WIRE RIBBON	83501	TEK-175-0829-00
-117	175-0832-00			FT						WIRE, ELECTRICAL: 0.542 FT 9 WIRE RIBBON	23499	TEK-175-0832-00

¹7A18N only.
²7A18 only.

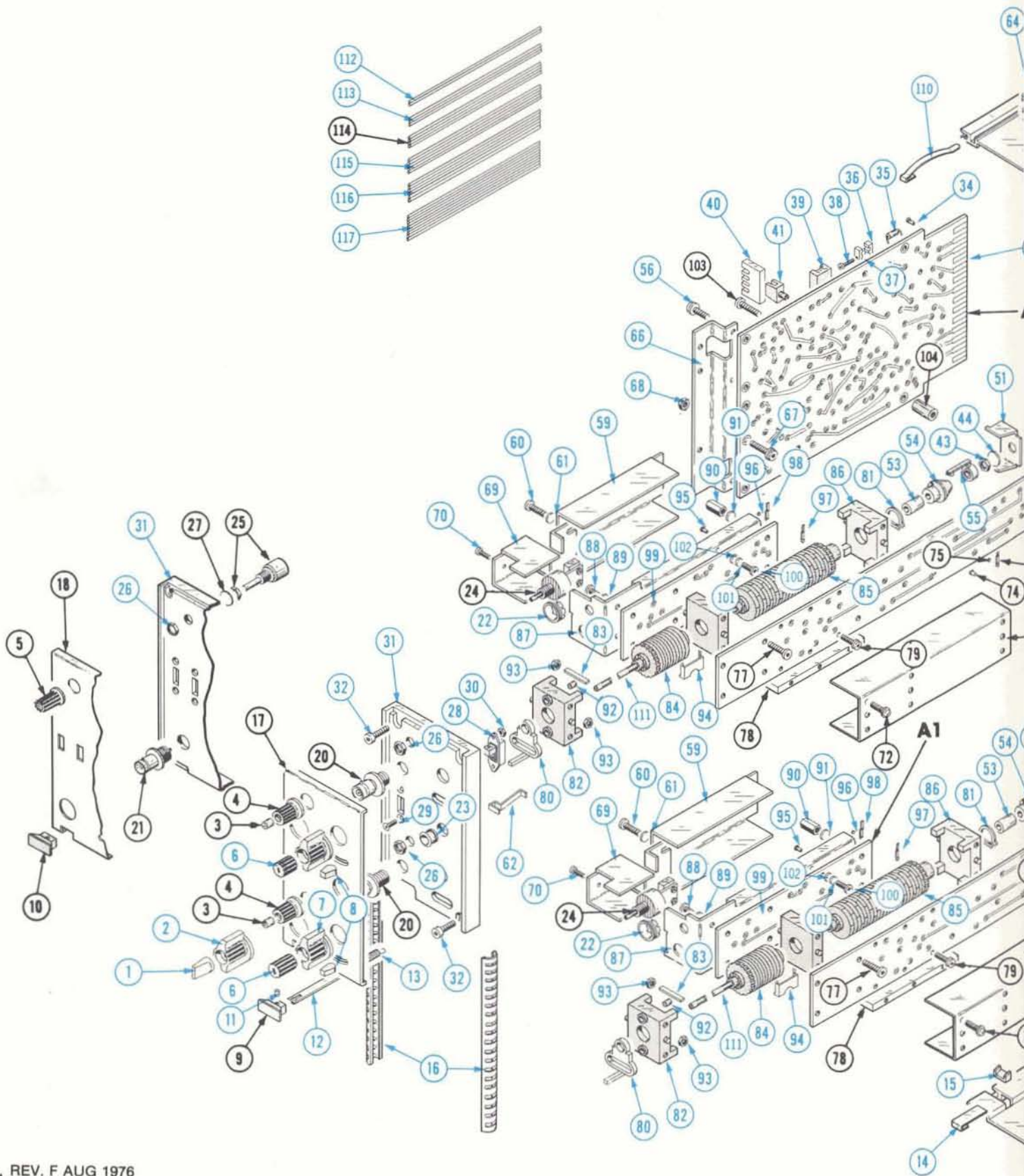

+

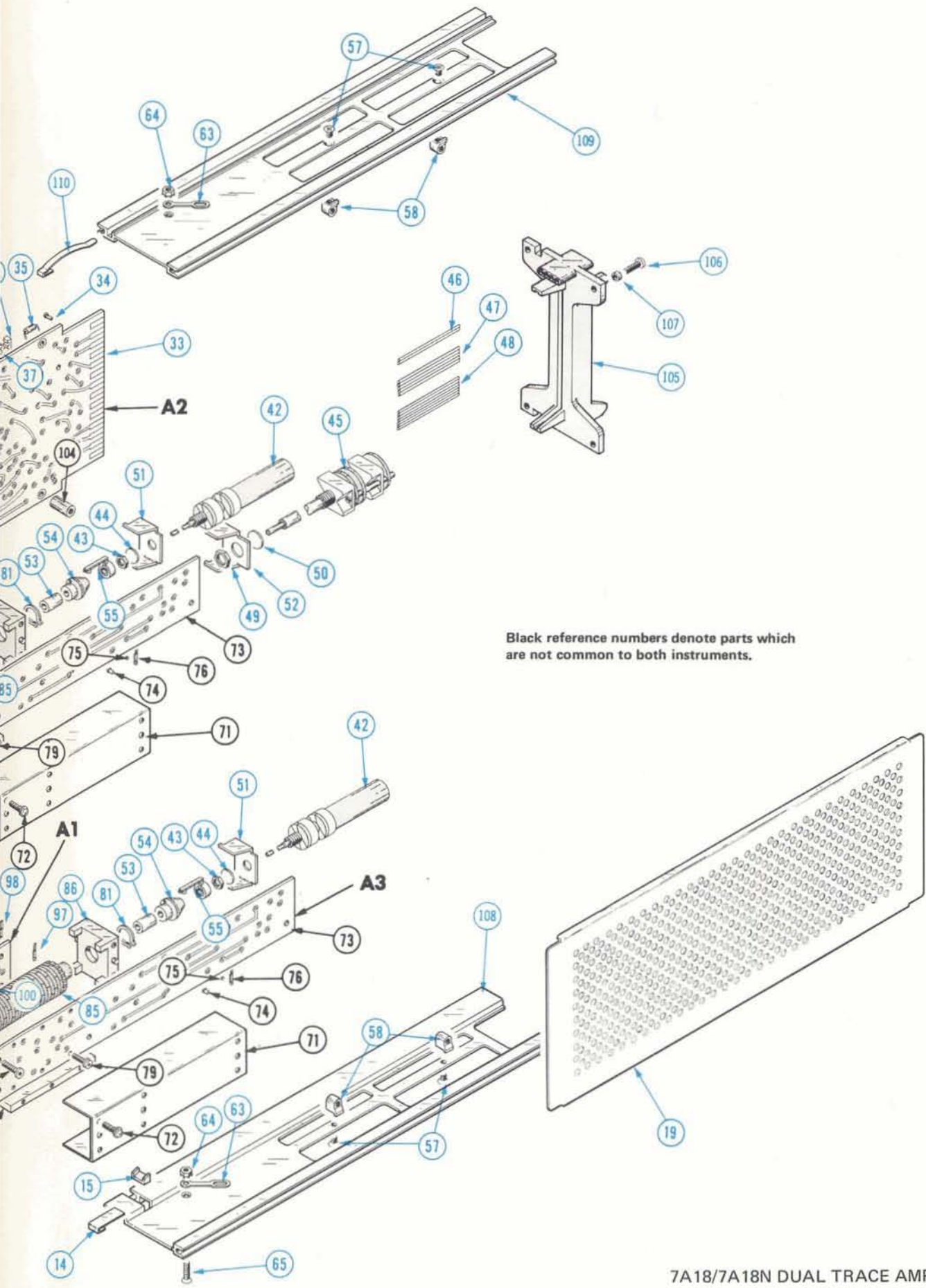

Black reference numbers denote parts which are not common to both instruments.

7A18/7A18N DUAL TRACE AMPLIFIERS

Fig. & Index No.	Tektronix Part No.	Serial/Model No. Eff	No. Dscont	Qty						Name & Description	Mfr	
					1	2	3	4	5		Code	Mfr Part Number
2-	070-1126-01			1						MANUAL, TECH: INSTRUCTION	80009	070-1126-01

FIG. 2 ACCESSORIES

MANUAL CHANGE INFORMATION

At Tektronix, we continually strive to keep up with latest electronic developments by adding circuit and component improvements to our instruments as soon as they are developed and tested.

Sometimes, due to printing and shipping requirements, we can't get these changes immediately into printed manuals. Hence, your manual may contain new change information on following pages.

A single change may affect several sections. Since the change information sheets are carried in the manual until all changes are permanently entered, some duplication may occur. If no such change pages appear following this page, your manual is correct as printed.

SERVICE NOTE

Because of the universal parts procurement problem, some electrical parts in your instrument may be different from those described in the Replaceable Electrical Parts List. The parts used will in no way alter or compromise the performance or reliability of this instrument. They are installed when necessary to ensure prompt delivery to the customer. Order replacement parts from the Replaceable Electrical Parts List.

CALIBRATION TEST EQUIPMENT REPLACEMENT

Calibration Test Equipment Chart

This chart compares TM 500 product performance to that of older Tektronix equipment. Only those characteristics where significant specification differences occur, are listed. In some cases the new instrument may not be a total functional replacement. Additional support instrumentation may be needed or a change in calibration procedure may be necessary.

Comparison of Main Characteristics

DM 501 replaces 7D13		
PG 501 replaces 107	PG 501 - Risetime less than 3.5 ns into 50 Ω .	107 - Risetime less than 3.0 ns into 50 Ω .
108	PG 501 - 5 V output pulse; 3.5 ns Risetime.	108 - 10 V output pulse; 1 ns Risetime.
111	PG 501 - Risetime less than 3.5 ns; 8 ns Pretrigger pulse delay.	111 - Risetime 0.5 ns; 30 to 250 ns Pretrigger Pulse delay.
114	PG 501 - ± 5 V output.	114 - ± 10 V output. Short proof output.
115	PG 501 - Does not have Paired, Burst, Gated, or Delayed pulse mode; ± 5 V dc Offset. Has ± 5 V output.	115 - Paired, Burst, Gated, and Delayed pulse mode; ± 10 V output. Short-proof output.
PG 502 replaces 107		
108	PG 502 - 5 V output	108 - 10 V output.
111	PG 502 - Risetime less than 1 ns; 10 ns Pretrigger pulse delay.	111 - Risetime 0.5 ns; 30 to 250 ns Pretrigger pulse delay.
114	PG 502 - ± 5 V output	114 - ± 10 V output. Short proof output.
115	PG 502 - Does not have Paired, Burst, Gated, Delayed & Undelayed pulse mode; Has ± 5 V output.	115 - Paired, Burst, Gated, Delayed & Undelayed pulse mode; ± 10 V output. Short-proof output.
2101	PG 502 - Does not have Paired or Delayed pulse. Has ± 5 V output.	2101 - Paired and Delayed pulse; 10 V output.
PG 506 replaces 106	PG 506 - Positive-going trigger output signal at least 1 V; High Amplitude output, 60 V.	106 - Positive and Negative-going trigger output signal, 50 ns and 1 V; High Amplitude output, 100 V.
067-0502-01	PG 506 - Does not have chopped feature.	0502-01 - Comparator output can be alternately chopped to a reference voltage.
SG 503 replaces 190, 190A, 190B	SG 503 - Amplitude range 5 mV to 5.5 V p-p.	190B - Amplitude range 40 mV to 10 V p-p.
191	SG 503 - Frequency range 250 kHz to 250 MHz.	191 - Frequency range 350 kHz to 100 MHz.
067-0532-01	SG 503 - Frequency range 250 kHz to 250 MHz.	0532-01 - Frequency range 65 MHz to 500 MHz.
TG 501 replaces 180, 180A	TG 501 - Marker outputs, 5 sec to 1 ns. Sinewave available at 5, 2, and 1 ns. Trigger output - slaved to marker output from 5 sec through 100 ns. One time-mark can be generated at a time.	180A - Marker outputs, 5 sec to 1 μ s. Sinewave available at 20, 10, and 2 ns. Trigger pulses 1, 10, 100 Hz; 1, 10, and 100 kHz. Multiple time-marks can be generated simultaneously.
181	TG 501 - Marker outputs, 5 sec to 1 ns. Sinewave available at 5, 2, and 1 ns.	181 - Marker outputs, 1, 10, 100, 1000, and 10,000 μ s, plus 10 ns sinewave.
184	TG 501 - Marker outputs, 5 sec to 1 ns. Sinewave available at 5, 2, and 1 ns. Trigger output - slaved to marker output from 5 sec through 100 ns. One time-mark can be generated at a time.	184 - Marker outputs, 5 sec to 2 ns. Sinewave available at 50, 20, 10, 5, and 2 ns. Separate trigger pulses of 1 and .1 sec; 10, 1, and .1 ms; 10 and 1 μ s. Marker amplifier provides positive or negative time marks of 25 V min. Marker intervals of 1 and .1 sec; 10, 1, and .1 ms; 10 and 1 μ s.
2901	TG 501 - Marker outputs, 5 sec to 1 ns. Sinewave available at 5, 2, and 1 ns. Trigger output - slaved to marker output from 5 sec through 100 ns. One time-mark can be generated at a time.	2901 - Marker outputs, 5 sec to 0.1 μ s. Sinewave available to 50, 10, and 5 ns. Separate trigger pulses, from 5 sec to 0.1 μ s. Multiple time-marks can be generated simultaneously.

NOTE: All TM 500 generator outputs are short-proof. All TM 500 plug-in instruments require TM 500-Series Power Module.

Scans By *Artek Media*

Artek Media
1042 Plummer Cir. SW
Rochester, MN 55902

www.artekmedia.com

“High resolution scans of obsolete technical manuals”

If your looking for a quality scanned technical manual in PDF format please visit our WEB site at www.artekmedia.com or drop us an email at manuals@artekmedia.com and we will be happy to email you a current list of the manuals we have available.

If you don't see the manual you need on the list drop us a line anyway we may still be able to point you to other sources. If you have an existing manual you would like scanned please write for details, This can often be done very reasonably in consideration for adding your manual to our library.

Typically the scans in our manuals are done as follows;

- 1) Typed text pages are typically scanned in black and white at 300 dpi.
- 2) Photo pages are typically scanned in gray scale mode at 600 dpi
- 3) Schematic diagram pages are typically scanned in black and white at 600 dpi unless the original manual had colored high lighting (as is the case for some 70's vintage Tektronix manuals).

If you purchased this manual from us (typically through our Ebay name of ArtekMedia) thank you very much. If you received this from a well-meaning “friend” for free we would appreciate your treating this much like you would “share ware”. By that we mean a donation of at least \$5-10 per manual is appreciated in recognition of the time (a manual can take as much as 40 hours to reproduce, book, link etc.), energy and quality of effort that went into preserving this manual. Donations via PayPal go to: manuals@artekmedia.com or can be mailed to us the address above.

Thanks



Dave & Lynn Henderson
Artek Media