



INSTRUCTION MANUAL

Tektronix, Inc.
P.O. Box 500
Beaverton, Oregon 97077

Serial Number _____

Scans By *Artek Media*

Artek Media
1042 Plummer Cir. SW
Rochester, MN 55902

www.artekmedia.com

"High resolution scans of obsolete technical manuals"

If you're looking for a quality scanned technical manual in PDF format please visit our WEB site at www.artekmedia.com or drop us an email at manuals@artekmedia.com and we will be happy to email you a current list of the manuals we have available.

If you don't see the manual you need on the list drop us a line anyway we may still be able to point you to other sources. If you have an existing manual you would like scanned please write for details, This can often be done very reasonably in consideration for adding your manual to our library.

Typically the scans in our manuals are done as follows;

- 1) Typed text pages are typically scanned in black and white at 300 dpi.
- 2) Photo pages are typically scanned in gray scale mode at 600 dpi
- 3) Schematic diagram pages are typically scanned in black and white at 600 dpi unless the original manual had colored high lighting (as is the case for some 70's vintage Tektronix manuals).

If you purchased this manual from us (typically through our Ebay name of ArtekMedia) thank you very much. If you received this from a well-meaning "friend" for free we would appreciate your treating this much like you would "share ware". By that we mean a donation of at least \$5-10 per manual is appreciated in recognition of the time (a manual can take as much as 40 hours to reproduce, book, link etc.), energy and quality of effort that went into preserving this manual. Donations via PayPal go to: manuals@artekmedia.com or can be mailed to us the address above.

Thanks



Dave & Lynn Henderson
Artek Media

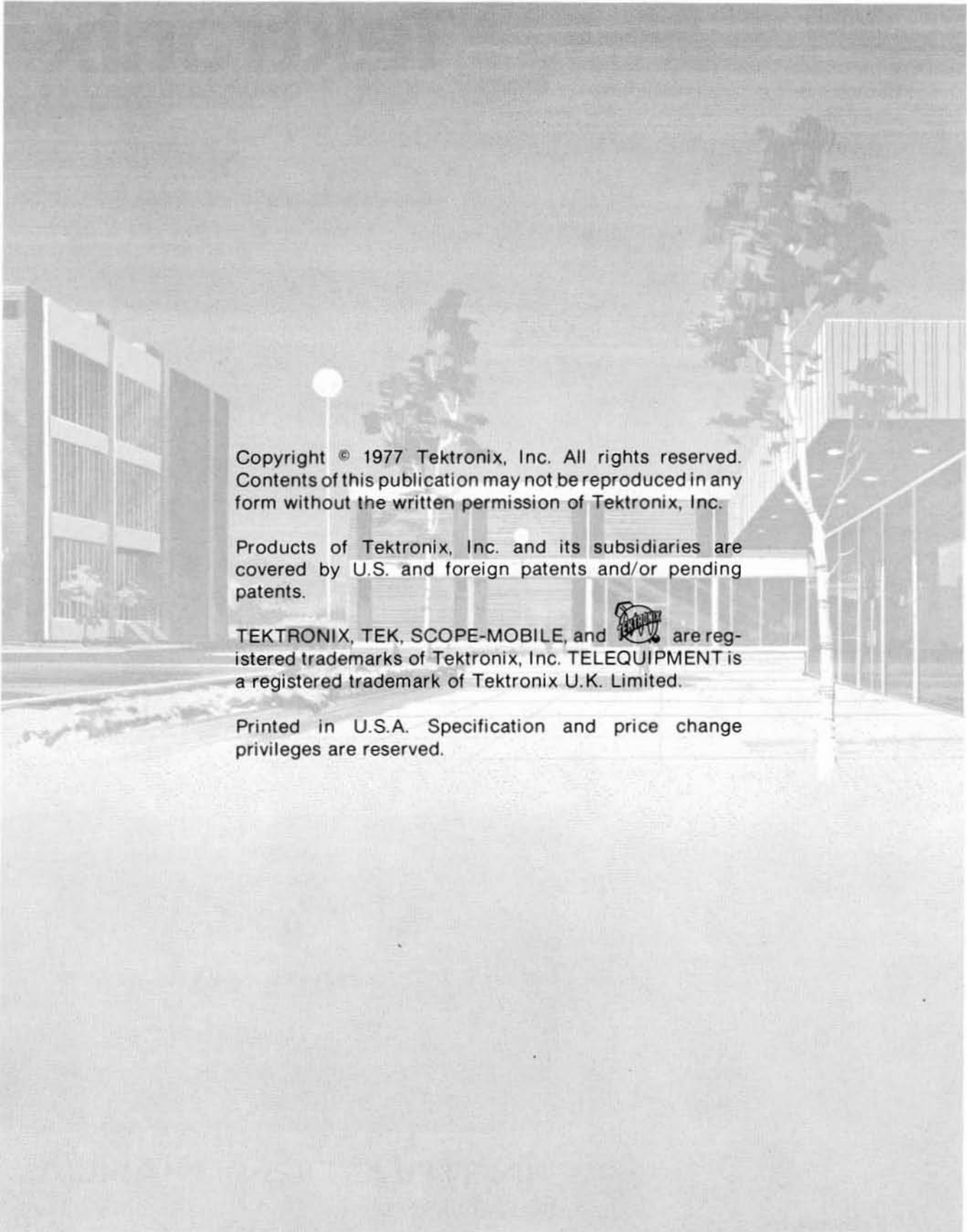

Copyright © 1977 Tektronix, Inc. All rights reserved.
Contents of this publication may not be reproduced in any
form without the written permission of Tektronix, Inc.

Products of Tektronix, Inc. and its subsidiaries are
covered by U.S. and foreign patents and/or pending
patents.

TEKTRONIX, TEK, SCOPE-MOBILE, and  are reg-
istered trademarks of Tektronix, Inc. TELEQUIPMENT is
a registered trademark of Tektronix U.K. Limited.

Printed in U.S.A. Specification and price change
privileges are reserved.

TABLE OF CONTENTS

	PAGE		PAGE
LIST OF ILLUSTRATIONS	ii	SECTION 4 MAINTENANCE	
LIST OF TABLES	ii	PREVENTIVE MAINTENANCE	4-1
SAFETY INFORMATION	iii	GENERAL	4-1
SECTION 1 OPERATING INSTRUCTIONS		CLEANING	4-1
CONTROLS AND CONNECTORS	1-1	LUBRICATION	4-1
FUNCTIONAL CHECK	1-1	TROUBLESHOOTING	4-3
SETUP PROCEDURE	1-1	GENERAL	4-3
CHECKOUT PROCEDURE	1-3	TROUBLESHOOTING AIDS	4-3
DETAILED OPERATING INFORMATION	1-3	TROUBLESHOOTING EQUIPMENT	4-4
INTRODUCTION	1-3	TROUBLESHOOTING PROCEDURE	4-4
SIGNAL CONNECTIONS	1-3	CORRECTIVE MAINTENANCE	4-6
VERTICAL GAIN CHECK AND ADJUSTMENT	1-3	GENERAL	4-6
INPUT COUPLING	1-3	OBTAINING REPLACEMENT PARTS	4-6
INPUT PROTECTION FUSE	1-4	SOLDERING TECHNIQUES	4-6
VERTICAL DEFLECTION FACTOR	1-4	COMPONENT REPLACEMENT	4-7
POLARITY SWITCHING	1-4	FUSE AND ATTENUATOR REPLACEMENT	4-7
DISPLAY MODES	1-4	SEMICONDUCTOR REPLACEMENT	4-7
TRIGGER MODES	1-4	CIRCUIT BOARD REMOVAL	4-7
TRACE IDENTIFICATION	1-5	INTERCONNECTING PINS	4-8
BASIC APPLICATIONS	1-5	SWITCH REPLACEMENT	4-8
GENERAL	1-5	READJUSTMENT AFTER REPAIR	4-9
PEAK-TO-PEAK VOLTAGE MEASUREMENTS	1-5	REPACKAGING FOR SHIPMENT	4-9
INSTANTANEOUS VOLTAGE MEASUREMENTS	1-6		
COMPARISON MEASUREMENTS	1-6	SECTION 5 PERFORMANCE CHECK AND ADJUSTMENT	
DUAL TRACE PHASE DIFFERENCE		PRELIMINARY INFORMATION	5-1
MEASUREMENTS	1-7	ADJUSTMENT INTERVAL	5-1
HIGH RESOLUTION PHASE MEASUREMENTS	1-8	TEKTRONIX FIELD SERVICE	5-1
COMMON MODE REJECTION	1-8	USING THIS PROCEDURE	5-1
SECTION 2 SPECIFICATION		TEST EQUIPMENT REQUIRED	5-1
Electrical	2-1	SPECIAL CALIBRATION FIXTURES	5-1
Environmental	2-2	TEST EQUIPMENT ALTERNATIVES	5-1
Physical	2-2	PRELIMINARY PROCEDURE	5-4
		INDEX TO PERFORMANCE CHECK AND	
		ADJUSTMENT PROCEDURE	5-4
		LOW FREQUENCY PROCEDURE	5-5
		HIGH FREQUENCY PROCEDURE	5-8
		SECTION 6 INSTRUMENT OPTIONS	
		SECTION 7 REPLACEABLE ELECTRICAL PARTS	
		SECTION 8 DIAGRAMS AND CIRCUIT BOARD	
		ILLUSTRATIONS	
		SECTION 9 REPLACEABLE MECHANICAL PARTS	
		CHANGE INFORMATION	

WARNING

THE REMAINING PORTION OF THIS TABLE OF CONTENTS LISTS THE SERVICING INSTRUCTIONS. THESE SERVICING INSTRUCTIONS ARE FOR USE BY QUALIFIED PERSONNEL ONLY. TO AVOID ELECTRICAL SHOCK, DO NOT PERFORM ANY SERVICING OTHER THAN THAT CALLED OUT IN THE OPERATING INSTRUCTIONS UNLESS QUALIFIED TO DO SO.

SECTION 3 THEORY OF OPERATION	
INTRODUCTION	3-1
BLOCK DIAGRAM	3-1
CH 1 AND CH 2 ATTENUATORS	3-1
CH 1 AND CH 2 AMPLIFIERS	3-2
DISPLAY SWITCHING AND OUTPUT	3-2
CH 1 AND CH 2 READOUT	3-3

LIST OF ILLUSTRATIONS

Figure No.		PAGE
1-1	7A24 Dual-Trace Amplifier	iv
1-2	Release Latch	1-1
1-3	7A24 Front-Panel Controls and Connectors	1-2
1-4	Measuring the peak-to-peak voltage of a waveform	1-5
1-5	Measuring instantaneous voltage with respect to some reference	1-6
1-6	Measuring phase difference between two signals	1-8
1-7	High resolution phase measurement using time-base magnifier	1-8
1-8	Using the ADD mode for common-mode rejection	1-9
2-1	7A24 dimensional drawing	2-2
4-1	Lubrication procedure for a typical cam switch	4-1
4-2	Color code for resistors and capacitors	4-2
4-3	Semiconductor electrode configurations	4-3
4-4	Orientation of multi-connector holders	4-4
4-5	Coaxial end-lead connector assembly	4-8
4-6	Exploded view of circuit-board pin and ferrule	4-9
5-1	Test circuit for Input Resistance Check/Adjust step	5-5
5-2	Approximately 2.5 division pulse obtained in step 11f	5-9
5-3	Short pulse before cancellation	5-9

The illustrations in Section 8 are located near their associated diagrams on foldout pages.

8-1	Circuit board locator.
8-2	Semiconductor lead configurations.
8-3	A1 and A3 Attenuator circuit board assembly.
8-4	A5 and A6 Amplifier circuit board assembly.
8-5	A5 and A6 Amplifier circuit board assembly.
8-6	A2 and A4 Readout circuit board assembly.
8-7	7A24 Adjustment locations.
8-8	7A24 Troubleshooting chart.

LIST OF TABLES

Table No.		PAGE
1-1	Trigger Signal Source	1-5
2-1	Electrical Specifications	2-1
2-2	Environmental Specifications	2-2
2-3	Physical Specifications	2-2
5-1	Test Equipment	5-2
5-2	Attenuator Accuracy	5-7

SAFETY INFORMATION

This manual contains safety information which the user must follow to ensure safe operation of this instrument. WARNING information is intended to protect the operator; CAUTION information is intended to protect the instrument. The following are general safety precautions that must be observed during all phases of operation and maintenance.

WARNING

GROUND THE INSTRUMENT

To reduce electrical-shock hazard, the mainframe (oscilloscope) chassis must be grounded. Refer to the mainframe manual for grounding information.

DO NOT OPERATE IN EXPLOSIVE ATMOSPHERE

Do not operate this instrument in an area where flammable gases or fumes are present. Such operation could cause an explosion.

AVOID LIVE CIRCUITS

Electrical-shock hazards are present in this instrument. The protective instrument covers must not be removed by operating personnel. Component replacement and internal adjustments must be referred to qualified service personnel.

DO NOT SERVICE OR ADJUST ALONE

Do not service or make internal adjustments to this instrument unless another person, capable of giving first aid and resuscitation, is present.

WARNING

WARNING STATEMENTS

Warning statements accompany potentially dangerous procedures in this manual. The following warnings appear in this manual and are listed here for additional emphasis.

To avoid electric-shock hazard, disconnect the instrument from the power source before soldering.

To avoid electric-shock hazard, disconnect the instrument from the power source before replacing components.



7A24 FEATURES

The 7A24 is a dual-channel, wide-bandwidth amplifier plug-in unit designed for use with Tektronix 7000-series Oscilloscopes. Each channel has an input impedance of 50 ohms and is internally fused. Internal attenuators and gain circuits are switched to correspond to the settings of the VOLT/DIV switches. Channel 2 can be inverted and added to channel 1 for differential measurements.

Figure 1-1. 7A24 Dual-Trace Amplifier.

OPERATING INSTRUCTIONS

The 7A24 Vertical Amplifier unit operates with any Tektronix 7000-series oscilloscope mainframe and any 7B-series time-base unit to form a complete oscilloscope system. This section of the manual describes the operation of the front-panel controls and connectors, provides a functional check procedure, detailed operating information, and basic applications for this instrument.

INSTALLATION

The 7A24 is calibrated and ready for use as received. It can be installed in any compartment of Tektronix 7000-series oscilloscopes, but is principally used in vertical plug-in compartments. To install, align the upper and lower rails of the 7A24 with the oscilloscope tracks and fully insert it. The 7A24 is fully inserted when the front is flush with the front of the oscilloscope and the latch at the bottom-left corner of the 7A24 is in place against the front panel. See Figure 1-2 for the latch location.

To remove the 7A24, pull on the latch (which is inscribed with the unit identification "7A24") and the 7A24 will unlatch. Continue pulling on the latch to slide the 7A24 out of the oscilloscope.

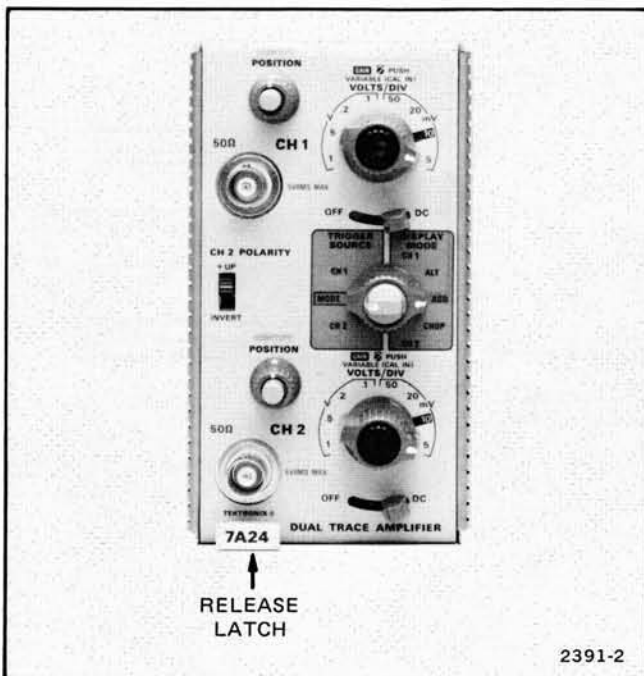

Figure 1-2. Release Latch.

CONTROLS AND CONNECTORS

All controls and connectors required for operation of the Vertical Amplifier are located on the front panel. Figure 1-3 provides a brief description of all front-

panel controls and connectors. See Detailed Operating Instructions for more information.

FUNCTIONAL CHECK

The following procedures are provided for checking basic instrument functions. Refer to the description of the controls and connectors while performing this procedure. If performing the functional check procedure reveals a malfunction or possible incorrect adjustment, first check the operation of the associated oscilloscope and plug-in units, then refer to the instruction manual for maintenance and adjustment procedures.

SETUP PROCEDURE

1. Insert the 7A24 into the left vertical plug-in compartment of a 7000-series oscilloscope mainframe.
2. Insert a 7000-series time-base unit into the B horizontal plug-in compartment.
3. Set the controls as follows:

7A24 Vertical Amplifier

CH 1, CH 2 POSITIONMidrange
 CH 2 POLARITY.....+UP
 CH 1, CH 2 VOLTS/DIV10 mV
 CH 1, CH 2 INPUT COUPLINGDC
 CH 1, CH 2 VARIABLE.....CAL IN
 DISPLAY MODE.....CH 1
 TRIGGER SOURCEMODE

Time Base

Level/Slope.....Centered on positive slope
 Triggering ModeP-P Auto or Auto
 CouplingAC
 Source.....Int
 Time/Div1 ms
 VariableCal In
 MagnifierIn
 PositionMidrange

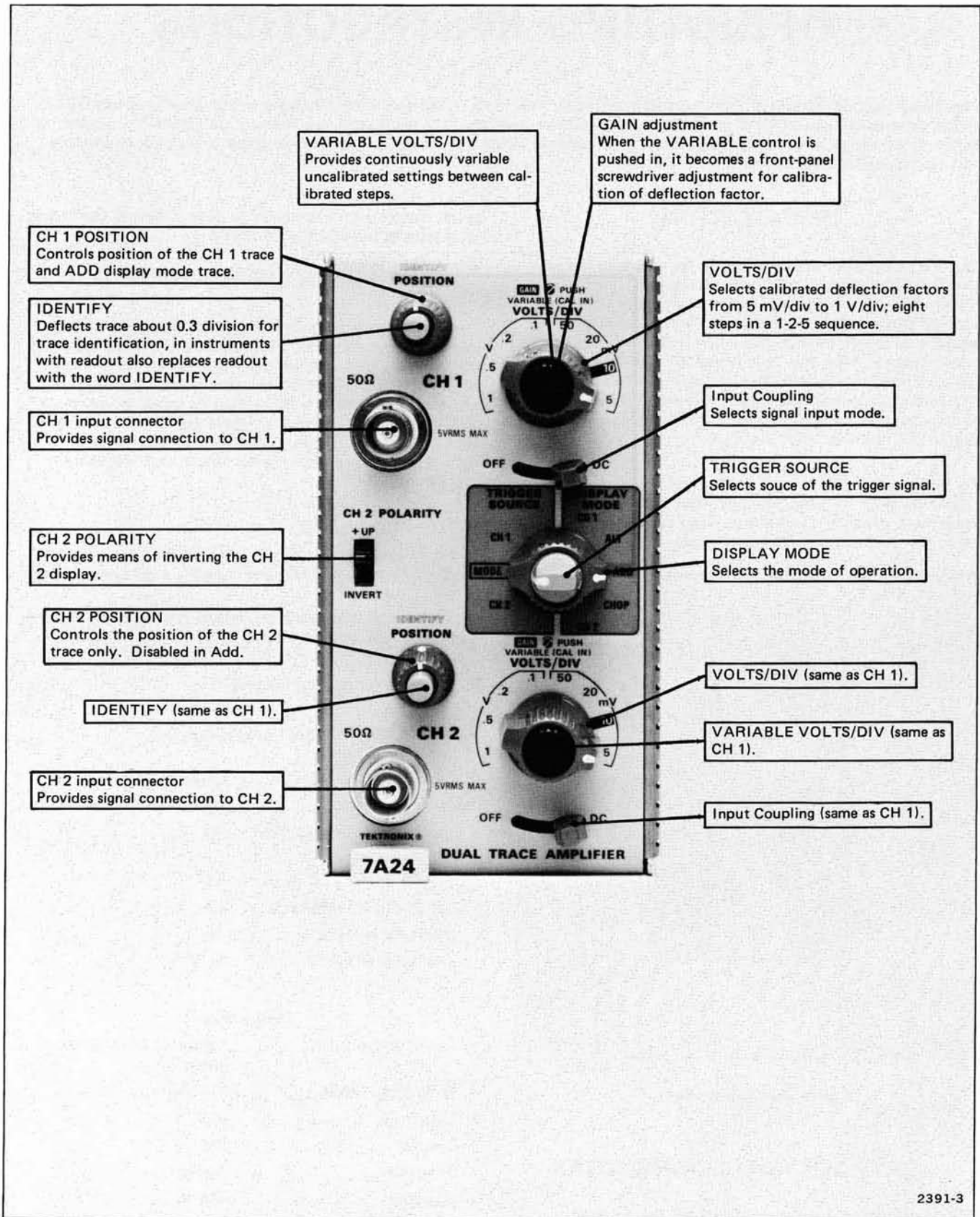

2391-3

Figure 1-3. 7A24 Front-Panel controls and connectors.

Mainframe

Vertical Mode.....Left
Horizontal ModeB
Intensity.....CCW
Calibrator1 kHz, 40 mV under load
Trigger Source.....Left Vert

4. Connect the mainframe to a power source which meets the voltage and frequency requirements of the mainframe power supply.
5. Turn the mainframe power on and allow about five minutes warmup.
6. Advance the Intensity until a free-running trace is observed. Adjust the position controls to center the trace on the crt.
7. Connect the mainframe calibrator output to the 7A24 CH 1 Input connector.

CHECKOUT PROCEDURE

8. Check the crt display for four divisions of vertical deflection. If necessary, push in the CH 1 VARIABLE control with a screwdriver and adjust the vertical gain for exactly four divisions.
9. Press the IDENTIFY button and check that the display moves upward about 0.3 divisions. Also check that the readout information on the crt is replaced by the word "IDENTIFY".
10. Press and release the CH 1 VARIABLE control to its outward position. Turn the VARIABLE control fully counterclockwise and check for 1.6 divisions or less display amplitude. Press the VARIABLE control to the CAL IN position.
11. Change the 7A24 Vertical Amplifier CH 1 VOLTS/DIV to 0.1 V, the mainframe calibrator volts to 0.4 V (0.2 V), and the time-base Triggering Source to Ext. Connect the calibrator output through a BNC T connector to the time-base Ext Trig In and the 7A24 CH 2 Input. Set the POLARITY switch to INVERT to display the opposite polarity of the square wave.
12. Return the POLARITY switch to +UP and set the TRIGGER SOURCE to CH 1. Change the time-base Triggering Source to Int and observe that the trace is no longer triggered.
13. Return the TRIGGER SOURCE to MODE and set the DISPLAY MODE to ADD. Observe that only the CH 1 POSITION control moves the trace.
14. Set the DISPLAY MODE to CHOP. Observe that the channel one trace is controlled by the CH 1 POSITION control and the channel two signal is controlled by the CH 2 POSITION control.

This completes the basic operating procedure for the 7A24. Instrument operation not explained here or operation which needs further explanation is discussed under Detailed Operating Information.

DETAILED OPERATING INFORMATION

INTRODUCTION

For single-trace operation, either of the two identical amplifier channels can be used independently by setting the DISPLAY MODE and TRIGGER SOURCE switches to CH 1 or CH 2 and connecting the signal to be observed to the appropriate Input. In the discussions to follow, single-trace operations using CH 1 only apply equally to CH 2 only.

SIGNAL CONNECTIONS

The 50-ohm input impedance of the 7A24 is ideally suited for making waveform measurements on 50-ohm systems, in that 50-ohm coaxial cables can be connected directly to the Input of the 7A24. The 7A24, however, should not be connected directly to a power supply, power line, or other voltage source that would exceed the input voltage limits of the 7A24 (see Specification section, Table 2-1). Probes recommended for use with the 7A24 are the P6056 (10X) and P6057 (100X). Both probes are compatible with 50-ohm systems, and will allow optimum frequency response. These probes also contain trace IDENTIFY and readout encoding functions. A one-megohm input impedance may be achieved by using the P6201 FET Probe.

VERTICAL GAIN CHECK AND ADJUSTMENT

To check the gain of either channel, set the VOLTS/DIV switch to 50 mV and connect a 0.4 V (under load), one-kilohertz signal from the oscilloscope calibrator to the Input connector of the channel being checked. The vertical deflection should be exactly four divisions. If not, adjust the front-panel GAIN for exactly four divisions of deflection. The GAIN adjustment is engaged by pressing in the GAIN control knob and turning the knob with a narrow-blade screwdriver (see Fig. 1-3, Front Panel Controls and Connectors). Turn the knob clockwise, then counterclockwise, until the GAIN control is engaged. When the GAIN control is engaged, the vertical deflection will change as the knob is turned. Turn the GAIN control knob with the screwdriver until the deflection is set to exactly four divisions, then remove the screwdriver.

INPUT COUPLING

The Channel 1 and Channel 2 Input Coupling (OFF-DC) switches select the signal input coupling mode.

Operating Instructions—7A24 (SN B103000 & UP)

DC

The DC position couples both ac and dc components of the signal into the input amplifier. A 50-ohm impedance is presented to the signal source.

OFF

The OFF position disconnects the signal source from the amplifier and connects it to a resistive 50-ohm termination.

INPUT PROTECTION FUSE

A fuse in the input of each channel protects the 7A24 from damage due to excessive signal voltages. If this fuse is open, no display can be obtained.

If no waveform can be displayed, but the POSITION control will move the trace on the crt, the condition of the fuse should be checked by a qualified service technician.

VERTICAL DEFLECTION FACTOR

The amount of vertical deflection produced by a signal is determined by the signal amplitude, the attenuation factor of the probe, the setting of the VOLTS/DIV switch, and the setting of the VARIABLE control. Calibrated deflection factors indicated by the settings of the VOLTS/DIV switch apply only when the VARIABLE control is in the calibrated (CAL IN) position.

The VARIABLE control provides variable, uncalibrated settings between the calibrated steps of the VOLTS/DIV switch. With the VARIABLE control fully counterclockwise and the VOLTS/DIV switch set to 1 volt/division the uncalibrated vertical deflection factor is extended to at least 2.5 volts/division. By applying a calibrated voltage source to the Input connector, any specific deflection factor can be set within the range of the VARIABLE control.

POLARITY SWITCHING

The CH 2 POLARITY switch may be used to invert the displayed waveform of the signal applied to the CH 2 Input. This is particularly useful in added-mode operation of the 7A24 when differential measurements are to be made. The CH 2 POLARITY switch has two positions, +UP and INVERT. In the +UP position, the displayed waveform will have the same polarity as the applied signal and a positive dc voltage will move the crt trace up. In the INVERT position, a waveform at the CH 2 Input will be displayed on the crt in inverted form and a positive dc voltage will move the trace down.

DISPLAY MODES

For single-trace operation, apply the signal either to the CH 1 Input or the CH 2 Input and set the DISPLAY MODE switch to the corresponding position: CH 1 or CH 2.

To display a signal in one channel independently when a signal is also applied to the other channel, simply select the desired channel by setting the DISPLAY MODE switch to the appropriate CH 1 or CH 2 position.

Alternate Mode

The ALT position of the DISPLAY MODE switch produces a display which alternates between Channel 1 and Channel 2 with each sweep on the crt.

Although the ALT mode can be used at all sweep rates, the CHOP mode provides a more satisfactory display at sweep rates below about 0.5 millisecond/division. At slow sweep rates, alternate mode switching becomes visually perceptible.

Add Mode

The ADD position of the DISPLAY MODE switch can be used to display the sum or difference of two signals, for common-mode rejection to remove an undesired signal, or for dc offset (applying a dc voltage to one channel to offset the dc component of a signal on the other channel). The overall deflection factor in the ADD mode with both VOLTS/DIV switches set to the same position is the deflection factor indicated by either VOLTS/DIV switch. However, if the CH 1 and CH 2 VOLTS/DIV switches are set to different deflection factors, the resultant amplitude is difficult to determine from the crt display. In this case, the voltage amplitude of the resultant display can be determined accurately only if the amplitude of the signal applied to one channel is known. In the ADD mode, positioning of the trace is controlled by the Channel 1 POSITION control only.

Chop Mode

The CHOP position of the DISPLAY MODE switch produces a display which is electronically switched between channels at approximately a 500 kilohertz rate (controlled by mainframe). In general the CHOP mode provides the best display at sweep rates slower than about 0.5 millisecond/division or whenever dual-trace, non-repetitive phenomena is to be displayed.

TRIGGER MODES

CH 1

The CH 1 position of the TRIGGER SOURCE switch provides a trigger signal obtained from the signal applied to the CH 1 Input connector. This provides a stable display of the signal applied to the CH 1 Input connector.

CH 2

The CH 2 position of the TRIGGER SOURCE switch provides a trigger signal obtained from the signal applied to the CH 2 Input connector. This provides a stable display of the signal applied to the CH 2 Input connector.

MODE

In this position of the TRIGGER SOURCE switch, the trigger signal for the time-base unit is dependent on the setting of the DISPLAY MODE switch. The trigger source for each position of the DISPLAY MODE switch is shown in Table 1-1.

TABLE 1-1
Trigger Mode Sources

Mode	Trigger Signal Source
CH 1	Channel 1
CH 2	Channel 2
ADD	Algebraic sum of Channel 1 and Channel 2
CHOP	Algebraic sum of Channel 1 and Channel 2
ALT	Alternates between Channel 1 and Channel 2

TRACE IDENTIFICATION

When the IDENTIFY button is pressed, the trace is deflected about 0.3 division to identify the 7A24 trace. This feature is particularly useful when multiple traces are displayed. In instruments with readout, pressing the IDENTIFY button also replaces the deflection factor readout with the word "IDENTIFY".

BASIC APPLICATIONS

GENERAL

The following information describes the procedures and techniques for making basic measurements with a 7A24 and the associated Tektronix oscilloscope and time base. These applications are not described in detail since each application must be adapted to the requirements of the individual measurements. This instrument can also be used for many applications not described in this manual. Contact your local Tektronix Field Office or representative for assistance in making specific measurements with this instrument.

PEAK-TO-PEAK VOLTAGE MEASUREMENTS

To make peak-to-peak voltage measurements, use the following procedure:

1. Apply the signal to either Input connector.
2. Set the DISPLAY MODE and TRIGGER SOURCE switches to display the channel used.
3. Set the Input Coupling switch to DC.
4. Set the VOLTS/DIV switch to display about five vertical divisions of the waveform.
5. Set the time-base Triggering controls for a stable display. Set the time-base unit to a sweep rate that displays several cycles of the waveform.

6. Turn the 7A24 POSITION control so the lower portion of the waveform coincides with one of the graticule lines below the center horizontal line, and the top of the waveform is within the viewing area. With the time-base Position control, move the display so one of the upper peaks lies near the center vertical line (see Fig. 1-4).

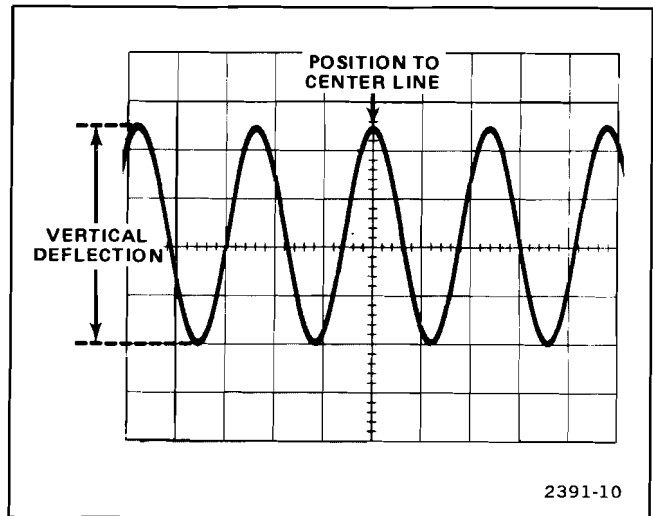

Figure 1-4. Measuring the peak-to-peak voltage of a waveform.

7. Measure the divisions of vertical deflection peak-to-peak. Check that the VARIABLE (VOLTS/DIV) control is in the CAL IN position.

NOTE

This technique can also be used to make measurements between two points on the waveform, rather than peak-to-peak.

8. Multiply the deflection measured in step 7 by the VOLTS/DIV switch setting. Include the attenuation factor of the probe, if used.

EXAMPLE: Assume that the peak-to-peak vertical deflection is 4.5 divisions (see Fig. 1-4) using a 10X attenuator probe, and the VOLTS/DIV switch is set to 1 V.

$$\text{Volts Peak-to-Peak} = \text{vertical deflection (divisions)} \times \text{VOLTS/DIV setting} \times \text{probe attenuation factor}$$

Substituting the given values:

$$\text{Volts Peak-to-Peak} = 4.5 \times 1 \times 10$$

The peak-to-peak voltage is 45 volts.

INSTANTANEOUS VOLTAGE MEASUREMENTS

To measure the dc level at a given point on a waveform, proceed as follows:

1. Connect the signal to either Input connector.
2. Set the DISPLAY MODE and TRIGGER SOURCE switches to display the channel used.
3. Set the VOLTS/DIV switch to display about five divisions of the waveform.
4. Set the Input Coupling switch to OFF and position the trace to the bottom graticule line or another reference line. If the voltage is negative with respect to ground, position the trace to the top graticule line. Do not move the POSITION control after this reference line has been established.

NOTE

To measure a voltage level with respect to a voltage other than ground, make the following changes to step 4: Set the Input Coupling switch to DC and apply the reference voltage to the Input connector, then position the trace to the reference line.

5. Set the Input Coupling switch to DC. The ground reference line can be checked at any time by switching to the OFF position.
6. Set the time-base Triggering controls for a stable display. Set the time-base sweep rate for an optimum display of the waveform.
7. Measure the distance in divisions between the reference line and the point on the waveform at which the dc level is to be measured. For example, in Figure 1-5 the measurement is between the reference line and point A.
8. Establish the polarity of the waveform. With the CH 2 POLARITY switch in the +UP position, any point above the reference line is positive.
9. Multiply the distance measured in step 7 by the VOLTS/DIV setting. Include the attenuation factor of the probe, if used.

EXAMPLE: Assume the vertical distance measured is 3.6 divisions (see Fig. 1-5) and the waveform is above the reference line using a 10X probe with a VOLTS/DIV setting of .5 V.

Using the formula:

$$\text{Instantaneous Voltage} = \text{vertical distance (divisions)} \times \text{polarity} \times \text{VOLTS/DIV setting} \times \text{probe attenuation factor}$$

Substituting the given values:

$$\text{Instantaneous Voltage} = 3.6 \times +1 \times 0.5 \text{ V} \times 10$$

The instantaneous voltage is 18 volts.

COMPARISON MEASUREMENTS

In some applications it may be desirable to establish arbitrary units of measurement other than those indicated by the VOLTS/DIV switch. This is particularly useful when comparing unknown signals to a reference amplitude. One use for the comparison-measurement technique is to facilitate calibration of equipment where the desired amplitude does not produce an exact number of divisions of deflection. The adjustment will be easier and more accurate if arbitrary units of measurement are established so that the correct adjustment is indicated by an exact number of divisions of deflection. The following procedure describes how to establish arbitrary units of measure for comparison measurements.

To establish an arbitrary vertical deflection factor based upon a specific reference amplitude, proceed as follows:

1. Connect the reference signal to the Input connector. Set the time-base unit sweep rate to display several cycles of the signal.
2. Set the VOLTS/DIV switch and the VARIABLE control to produce a display which is an exact number of vertical divisions in amplitude. Do not change the VARIABLE control after obtaining the desired deflection.

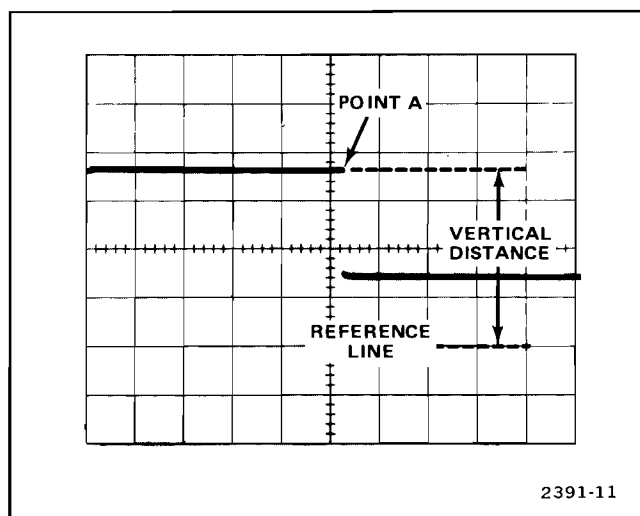

Figure 1-5. Measuring instantaneous voltage with respect to some reference.

3. To establish an arbitrary vertical deflection factor so that the amplitude of an unknown signal can be measured accurately at any setting of the VOLTS/DIV switch, the amplitude of the reference signal must be known. If it is not known, it can be measured before the VARIABLE VOLTS/DIV control is set in step 2.

4. Divide the amplitude of the reference signal (volts) by the product of the vertical deflection (divisions) established in step 2 and the setting of the VOLTS/DIV switch. This is the vertical conversion factor.

$$\text{Vertical Conversion Factor} = \frac{\text{reference signal amplitude (volts)}}{\text{vertical deflection (divisions)} \times \text{VOLTS/DIV switch setting}}$$

5. To measure the amplitude of an unknown signal, disconnect the reference signal and connect the unknown signal to the Input connector. Set the VOLTS/DIV switch to a setting that provides sufficient vertical deflection to make an accurate measurement. Do not readjust the VARIABLE control.

6. Measure the vertical deflection in divisions and calculate the amplitude of the unknown signal using the following formula:

$$\text{Signal Amplitude} = \text{VOLTS/DIV setting} \times \text{vertical conversion factor} \times \text{vertical deflection (divisions)}$$

EXAMPLE: Assume a reference signal amplitude of 3 volts, a VOLTS/DIV setting of .5 V, and the VARIABLE control adjusted to provide a vertical deflection of four divisions. Substituting these values in the vertical conversion factor formula (step 4):

$$\text{Vertical Conversion Factor} = \frac{3 \text{ V}}{4 \times .5 \text{ V}} = 1.5$$

Then with a VOLTS/DIV setting of .2 V, the peak-to-peak amplitude of an unknown signal which produces a vertical deflection of five divisions can be determined by using the signal amplitude formula (step 6):

$$\text{Signal Amplitude} = .2 \text{ V} \times 1.5 \times 5 = 1.5 \text{ volts}$$

DUAL-TRACE PHASE DIFFERENCE MEASUREMENTS

Phase comparison between two signals of the same frequency can be made using the dual-trace feature of the 7A24. This method of phase-difference measurement can be used up to the frequency limit of the oscilloscope system. To make the comparison, use the following procedure:

1. Set the CH 1 and CH 2 Input Coupling switches to DC.
2. Set the DISPLAY MODE to ALT or CHOP. In general, CHOP is more suitable for low frequencies and ALT is more suitable for high frequencies. Set the TRIGGER SOURCE to CH 1.
3. Connect the reference signal to the CH 1 Input and the comparison signal to the CH 2 Input. Use coaxial cables or probes which have similar time-delay characteristics to connect the signals to the input connectors.
4. If the signals are of opposite polarity, set the CH 2 POLARITY switch to invert the Channel 2 display. (Signals may be of opposite polarity due to 180° phase difference; if so, take this into account in the final calculation.)
5. Set the VOLTS/DIV switches and the VARIABLE controls of the two channels so the displays are equal and about five divisions in amplitude.
6. Set the time-base unit to a sweep rate which displays about one cycle of each waveform. Set the Triggering controls for a stable display.
7. Center the waveforms on the graticule with the 7A24 POSITION controls.
8. Adjust the time-base Variable Time/Div control until one cycle of the reference signal occupies exactly eight horizontal divisions between the second and tenth vertical lines of the graticule (see Fig. 1-6). Each division of the graticule represents 45° of the cycle (360° ÷ 8 divisions = 45°/division). The sweep rate can now be stated in terms of degrees; for example, 45°/division.
9. Measure the horizontal difference between corresponding points on the waveform.
10. Multiply the measured distance (in divisions) by 45°/division to obtain the exact amount of phase difference.

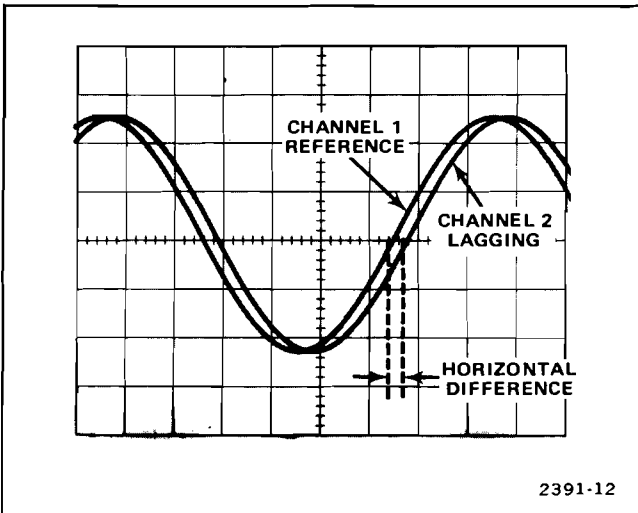

Figure 1-6. Measuring phase difference between two signals.

EXAMPLE: Assume a horizontal difference of 0.3 division with a sweep rate of 45°/division as shown in Figure 1-6.

Using the formula:

$$\text{Phase Difference} = \text{horizontal difference (divisions)} \times \text{sweep rate (degrees/division)}$$

Substituting the given values:

$$\text{Phase Difference} = 0.3 \times 45^\circ$$

The phase difference is 13.5°.

HIGH-RESOLUTION PHASE MEASUREMENTS

More accurate dual-trace phase measurements can be made by increasing the sweep rate (without changing the Variable Time/Div control). One of the easiest ways to increase the sweep rate is with the time-base Magnifier switch. Set the Magnifier to X10 and determine the magnified sweep rate by dividing the sweep rate obtained previously by the amount of sweep magnification.

EXAMPLE: If the sweep rate is increased 10 times by the Magnifier, the magnified sweep rate is 45°/division ÷ 10 = 4.5°/division. Figure 1-7 shows the same signals as used in Figure 1-6 but with the Magnifier set to X10. With a horizontal difference of 3 divisions, the phase difference is:

$$\text{Phase Difference} = \text{horizontal difference (divisions)} \times \text{magnified sweep rate (degrees/division)}$$

Substituting the given values:

$$\text{Phase Difference} = 3 \times 4.5^\circ$$

The phase difference is 13.5°.

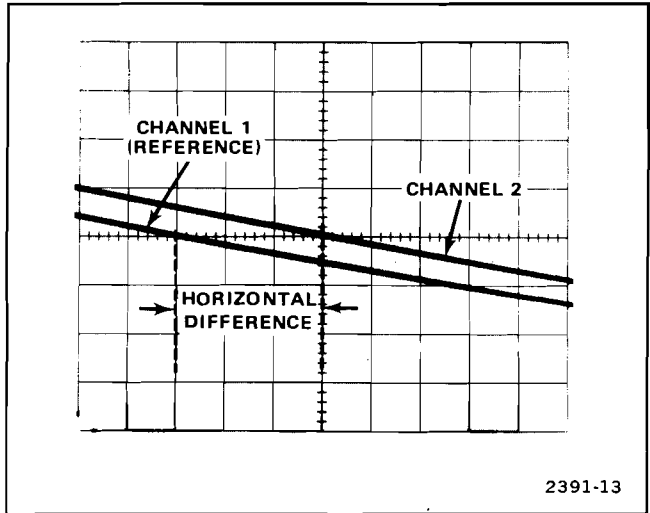

Figure 1-7. High resolution phase measurement using time-base magnifier.

COMMON-MODE REJECTION

The ADD feature of the 7A24 can be used to display signals which contain undesirable components. Undesirable common-mode signals of 8 divisions or less can be eliminated by using the 7A24 as a differential amplifier in ADD mode. The procedure is as follows:

1. Set the DISPLAY MODE switch to ALT or CHOP and the TRIGGER SOURCE switch to MODE.
2. Connect the signal containing both the desired and undesired information to the CH 1 Input connector.
3. Connect a signal similar to the unwanted portion of the CH 1 signal to the CH 2 Input connector. For example, in Figure 1-8 a line-frequency signal is connected to Channel 2 to cancel out the line-frequency component of the Channel 1 signal.
4. Set both Input Coupling switches to the DC position.
5. Set the VOLTS/DIV switches so the signals are about equal in amplitude.
6. Set the DISPLAY MODE switch to ADD. Set the CH 2 POLARITY switch to INVERT so the common-mode signals are of opposite polarity.

7. Adjust the Channel 2 VOLTS/DIV switch and VARIABLE control for maximum cancellation of the common-mode signal. The signal which remains should be only the desired portion of the Channel 1 signal.

EXAMPLE: An example of this mode of operation is shown in Figure 1-8. The signal applied to Channel 1 contains unwanted line-frequency components (Fig. 1-8A). A corresponding line-frequency signal is connected to Channel 2 (Fig. 1-8B). Figure 1-8C shows the desired portion of the signal as displayed when common-mode rejection is used.

The above procedure can also be used for examining a signal superimposed on some dc level. A dc voltage of the proper polarity applied to Channel 2 can be used to cancel out the dc portion of the signal applied to Channel 1.

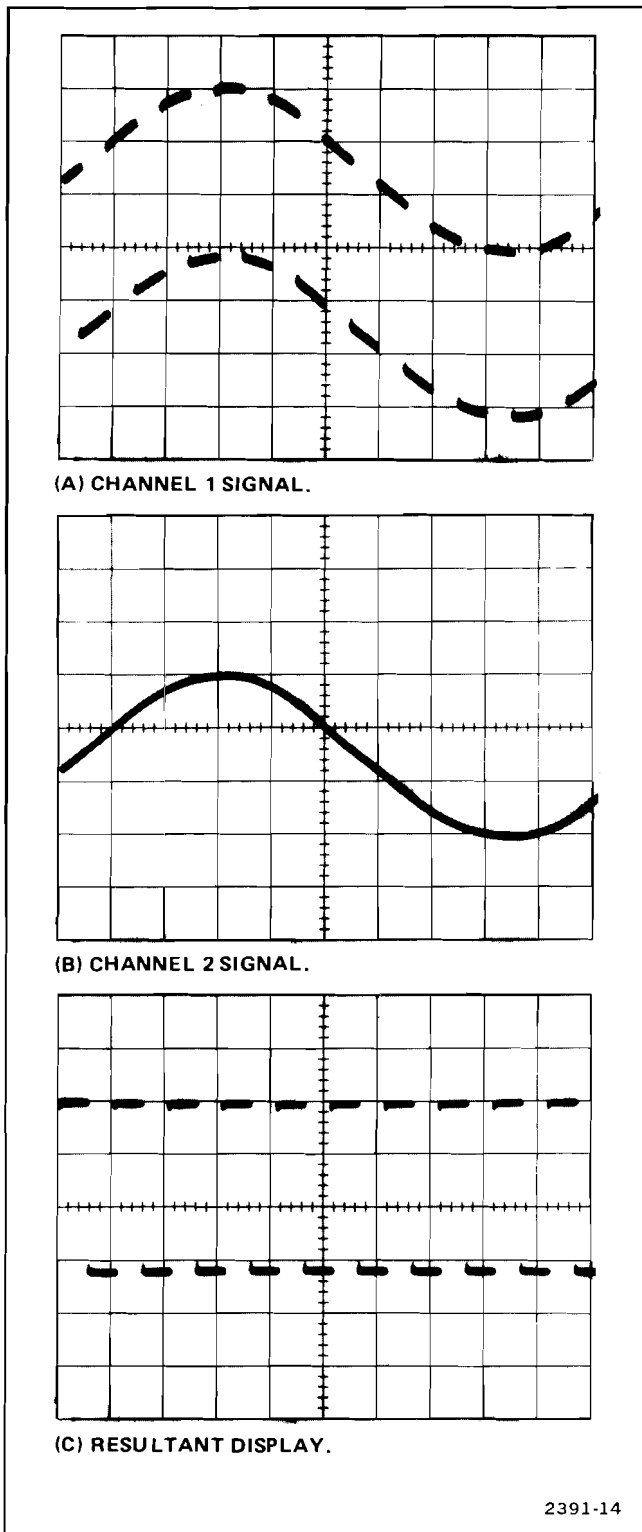

Figure 1-8. Using the ADD mode for common-mode rejection. (A) Channel 1 signal contains desired information along with line-frequency component. (B) Channel 2 contains line frequency only. (C) Resultant CRT display using common-mode rejection.

SPECIFICATION

The following electrical characteristics are valid over the stated environmental range for instruments calibrated at an ambient temperature of +20° to +30° C, and after a twenty-minute warmup unless otherwise noted.

TABLE 2-1
Electrical

Characteristic	Performance Requirement
Deflection Factor Calibrated Range	5 mV/Div to 1 V/Div; eight steps in a 1, 2, 5 sequence.
Gain Ratio Accuracy	±2% of indicated deflection factor with GAIN adjusted at 10 mV/Div.
Uncalibrated (VARIABLE)	Continuously variable between calibrated steps; extends deflection factor to at least 2.5 volts per division.
GAIN Range	Permits adjustment of deflection factor for calibrated operation with all Tektronix 7000-series oscilloscopes.
Frequency Response Bandwidth	Refer to 7000-series Oscilloscope specification for system bandwidths.
Maximum Input Voltage	5 volts rms (0.5 watts).
Input Characteristics DC Resistance	50.0 ohms, ±1.0 Ω dc coupled.
VSWR	5 mV to 10 mV: ≤1.25 dc to 250 MHz ≤1.30 250 MHz to 350 MHz ≤1.40 350 MHz to 400 MHz 20 mV to 1 V: ≤1.15 dc to 400 MHz
Common-Mode Rejection Ratio	At least 10:1, dc to 50 MHz, with 8 divisions or less common-mode signal.
Display Modes	Channel 1 only. Dual-trace, alternate between channels. Added algebraically. Dual-trace, chopped between channels. Channel 2 only.
Trigger Source Selection	Channel 1 only. Follows DISPLAY MODE selection. Channel 2 only.

TABLE 2-2
Environmental

Characteristic	Information
Temperature	Refer to 7000-series Oscilloscope System—EIS001B Specification; associated 7000-series Mainframe.
Altitude	
EMC	
Transportation	Qualified under NSTC Test Procedure 1A, Category II.

TABLE 2-3
Physical

Characteristic	Information
Size	Fits all 7000-series plug-in compartments.
Weight	1.2 Kilograms (2 Pounds 9 Ounces).

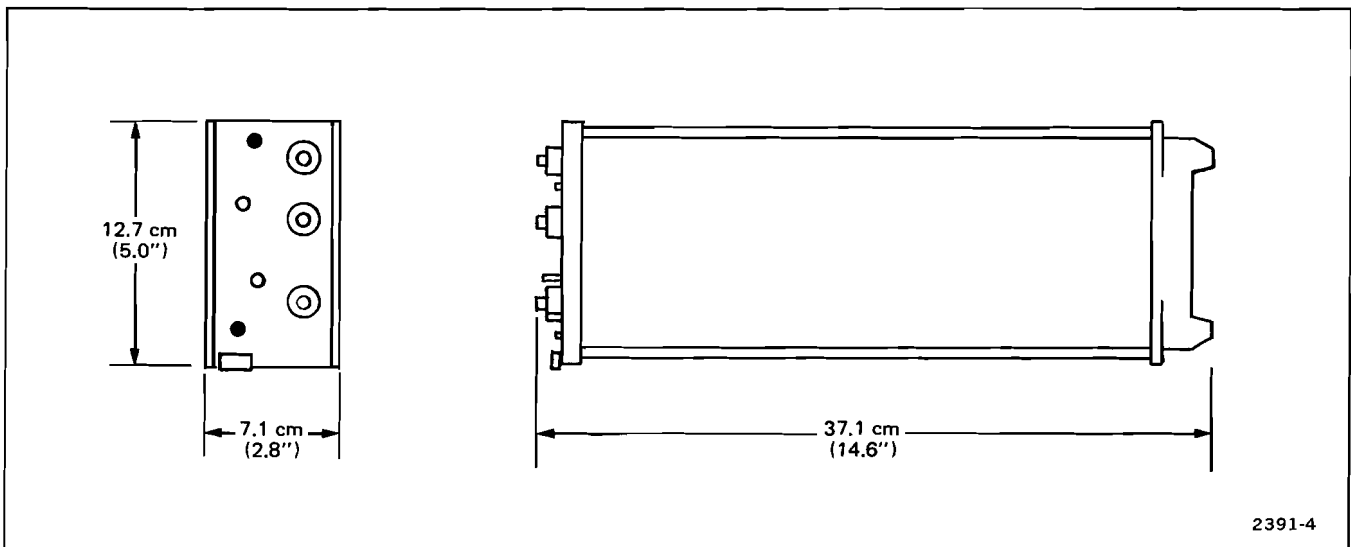

Figure 2-1. 7A24 dimensional drawing.

THEORY OF OPERATION

INTRODUCTION

This section of the manual contains a description of the circuitry used in the 7A24. The 7A24 description begins with a discussion of the instrument using the block diagram shown in the Diagrams section. The circuit diagrams are segmented with gray-tint blocks named according to circuit function. These circuit block titles serve as indexes to the circuit discussion. Detailed diagrams of each circuit are located in the diagram foldout section at the rear of this manual. Refer to the appropriate diagram when reading this discussion.

BLOCK DIAGRAM

The Channel 1 Amplifier circuit provides gain setting, variable gain control, and trace positioning. The Channel 2 Amplifier provides signal-polarity inversion in addition to gain setting, variable gain control, and trace positioning. The signal to be displayed on the crt is applied to the CH 1 or CH 2 Input connector. The signal passes through the Input Coupling switch, where it is either connected to the attenuators or to a 50-ohm dummy load. The VOLTS/DIV switch selects the correct amount of attenuation, and the signal is passed to the Switched-Gain Amplifier.

When the VOLTS/DIV switch is set to the 5 mV and 10 mV positions, the signal connected to the Input connector is passed through the attenuators without attenuation. When the VOLTS/DIV switch is set in the 5 mV position, the Switched-Gain Amplifier operates at full gain. In all other positions of the VOLTS/DIV switch, the gain of the Switched-Gain Amplifier is reduced by two. Internal gain and balance adjustments are included in the Switched-Gain Amplifier.

Overall GAIN and VARIABLE gain are adjusted in the Gain Amplifier. Variable balance and high-frequency adjustments are also controlled in the Gain Amplifier. The output of the Gain Amplifier is connected to the Positioning circuitry where the POSITION and IDENTIFY functions are controlled. This circuitry also shifts the signal level to provide zero volts at the plug-in output. Channel 2 is identical to Channel 1, with the exception of the polarity-inversion function in Channel 2.

The Signal Splitter Amplifier divides the signal for use at the Display and Trigger Channel Switching amplifiers.

The Display and Trigger Channel Switching amplifiers provide differential signal outputs for the signal and trigger lines, from each channel, to a common display and trigger output.

The output of the Display and Trigger Channel Switching amplifiers are connected to the oscilloscope mainframe via the interface connector.

Readout encoding circuitry used in the 7A24 is compatible with all 7000-series mainframes.

CH 1 AND CH 2 ATTENUATORS

NOTE

The CH 1 and CH 2 amplifier circuits are identical with the exception of the CH 2 GAIN stage U2450, which includes a POLARITY inverting circuit. Only CH 2 is described in detail throughout this discussion.

INPUT FUSE AND SWITCH

Signals connected to the Input connector pass through a 0.2 ampere fuse (F100) before reaching the Input Coupling switch. The fuse protects the attenuators and amplifier by preventing excessive voltages from reaching these components.

Input signals can be dc-coupled or internally disconnected. S100A is a cam-type switch; a contact-closure chart showing the operation is given on the schematic diagrams. When the Input Coupling switch is in the DC position, the input signal is connected to the attenuators. The OFF position opens the signal path to the attenuators and connects the input signal to an internal 50-ohm dummy load. This provides a ground reference without the need to disconnect the applied signal from the Input connector, and presents a constant 50-ohm load at the Input connector.

INPUT ATTENUATOR

The effective overall deflection factor of the 7A24 is determined by the setting of the VOLTS/DIV switch, S100B. The basic deflection factor is 10 millivolts per division of crt deflection. To increase the deflection factor to the values indicated on the front panel, precision attenuators are switched into the circuit. S100B is a cam-type switch. The dots on the contact-closure chart (see Diagram 1) indicate when the associated contacts are in the position shown (open or closed). In the 5 mV/Div and 10 mV/Div positions, the attenuators are not used; the input signal is connected directly to the Switched-Gain Amplifier. The 10 mV/Div position decreases the gain of the Switched-Gain Amplifier. For switch positions above 10 mV/Div, the attenuators are either switched into the circuit singly or are stacked, producing the

Theory of Operation—7A24 (SN B103000 & UP)

deflection factor indicated on the front panel. The hybrid attenuators are constant impedance, T-pad dividers. In addition to providing constant attenuation at all frequencies within the bandwidth of the instrument, the input attenuators are designed to maintain the same input impedance (50 ohms) for all settings of the VOLTS/DIV switch.

CH 1 AND CH 2 AMPLIFIERS

SWITCHED-GAIN AMPLIFIER

The coaxial coupler between the Attenuator circuit board and the Main Amplifier circuit board acts as a balun transformer to provide differential drive to U1350 at high frequencies. U1350 is a paraphase-type amplifier with dual differential outputs.

In the 5 mV position, full drive is provided from pins 5 and 9 of U1350 to the U1450 load resistors, R1401 and R1403. In all other attenuator positions, the signal-path drive current through the load resistors is divided in half. The other half is diverted through pins 6 and 8 of U1350 and is dissipated in dummy-load resistors R1334 and R1336. Resistor R1332 sets the basic gain by a factor of two for all positions of the VOLTS/DIV switch except 5 mV.

Components CR1319 and R1319 maintain proper collector voltage while switching between the 5 mV and 10 mV positions. Components C1332 and R1332 compensate for thermal variations. Components R1336 and C1336 are high-frequency adjustments.

Fixed length inductors and capacitors are part of the Amplifier etched circuit board and provide T-coil peaking at the input of U1350.

GAIN AND POLARITY INVERT AMPLIFIER

Integrated circuit U2450 is a variable-gain cascode amplifier which sets the overall channel gain. The GAIN (R2432B) and VARIABLE (R2432A) controls determine the ratio of base currents through pins 11 and 12 of U2450. The base-current ratio determines the shared collector output levels between pins 5-6, 8-9.

Variable resistor R2424 provides adjustable low-frequency compensation. Resistors R2422 and RT2420 compensate for temperature variations. Components R2430 and C2430 provide adjustable high-frequency compensation. The U2450 input T-coil peaking inductors and capacitors are part of the circuit board. Dc balance over the variable range is adjusted by R2410.

LEVEL SHIFT AND POSITION CONTROL

This circuitry shifts the dc level between U2450 and U2550, and provides positioning current.

Low frequency and dc signals are coupled through R2450, L2450, Q2450, R2455 and R2460, L2460, Q2460, R2455 which shifts the quiescent level from +8 volts to -8 volts. Capacitors C2450 and C2460, located in the transmission line between U2450 and U2550, provide ac coupling for high-frequency signals. Resistors R2452 and R2462 provide operating current for Q2450, Q2460, and U2450 while R2467 and R2468 set the operating point of these devices. The level shifter gain is unity.

Transistors Q2470 and Q2480 are current sources which add positioning current to the input of U2550. When POSITION control R2487 is at center, Q2470 and Q2480 provide equal currents resulting in zero offset current. As the control is rotated from center the differential offset at Q2470 and Q2480 produces a corresponding amount of positioning current. Resistors R2473, R2483, R2486, and R2487 form a base voltage divider for Q2470 and Q2480 in all display modes except ADD. In ADD, CR2474 and CR2484 conduct, which replaces R2487 with R2474 and R2484. Thus, the CH 2 POSITION control is disabled in ADD mode which limits position control to Channel 1 only.

The IDENTIFY circuit, composed of R2488, CR2488, and S2465, adds enough current to Q2480 to produce approximately 0.3 division trace shift at the crt for trace identification. When S2465 is closed, the junction of CR2488, R2488, and R2489 becomes more positive resulting in additional emitter current at Q2480 (approximately 200 microamps). When the switch is open, the junction shifts more negative and less emitter current flows. In this condition, when a multiplier probe is connected to the CH 2 Input, the additional resistance to ground produces just enough current shift at the readout circuit (Diagram 4) to indicate the appropriate multiplier on the crt.

SIGNAL SPLITTER AMPLIFIER

Integrated circuit U2550 provides two separate signals for use in the display and trigger channel switches on Diagram 3. Components C2515 and R2515 provide adjustable high frequency compensation. Output transient response is adjustable at C2560, C2562, R2560, and R2562.

DISPLAY SWITCHING AND OUTPUT

DISPLAY AND TRIGGER SWITCHING

The display and trigger channel switches provide selection of the channel one and/or channel two signals from the Switching Amplifiers on Diagram 2 for use in the mainframe.

Switching control is provided by the Switch Control circuits described later.

Integrated circuit U2750 passes or blocks the Channel 2 display signal depending on logic levels at pins 11 and 12. The signal is passed when a high appears at pin 12 and blocked when a low is at pin 12. Pin 11 follows the opposite state. When the switch is off, the signal appears at output pins 6 and 8. Ic U1750's operation is identical to U2750. The output signals of both switches are combined, terminated, and fed to display out terminals. Capacitor C2753 adjusts high-frequency compensation.

Trigger channel switches U1850 and U2850 operate in a similar manner as the display channel switches. Components C1857, C2857, R1857, and R2857 compensate for additional trigger pickoff transmission line losses.

SWITCH CONTROL

Since the display and trigger switch control circuits are identical, only the display circuit is described in detail.

Transistors Q1920, Q1930 and Q1940, Q1950 are unity gain paraphrase amplifiers that control the channel one and channel two switches, respectively. Display commands from the mode switch are level shifted and applied to the channel switches. Transistor Q1910 is a voltage source for both amplifiers. In the ADD mode, Q1950 is forced on by Q1960 causing both channel switches to simultaneously pass signals. Components CR1970 and R1970 correct the common mode output voltage level when the channel switches are in ADD mode.

CH 1 AND CH 2 READOUT

READOUT ENCODING

The Readout Encoding circuit consists of switching resistors and probe sensing stage Q620. This circuit encodes the Channel 1 and 2, Row and Column output lines for readout of deflection factor, uncalibrated deflection factor (VARIABLE) information, and signal inversion (Channel 2 only). Data is encoded on these output lines by switching resistors between them and the time-slot input lines, or by adding current through Q620.

Components R647-CR647 are switched between time-slot three (TS-3) and Column output line when the CAL IN switch is in the uncal position. This results in the symbol > (greater than) being displayed preceding the deflection factor readout. Resistor R648 (Channel 2 only) is switched between TS-2 and the Column output line when the CH 2 POLARITY switch is in the INVERT position. This results in the symbol † (inverted) being displayed preceding the deflection factor readout.

Switching resistors are used to indicate the setting of the

VOLTS/DIV switch to the mainframe readout system. The VOLTS/DIV switch is a cam-type switch. The dots on the contact-closure chart (see Diagram 4) indicate when the associated contacts are closed. Resistors R633, R634, and R635 select the numbers 1, 2, or 5 depending on the resistor combination that is switched in. Resistors R636, R642 select the m (milli-) prefix and R639 and R643 select the symbol V (volts) in the 5 mV through 0.5 V (500 mV) positions of the VOLTS/DIV switch. Resistors R636 and R642 select the symbol V in the 1 V position. Resistors R630, R631, and the output of the probe sensing stage (Q620) select the decimal point (number of zeroes), again depending on the resistor combination switched in by the VOLTS/DIV switch.

Probe sensing stage Q620 identifies the attenuation factor of the probe connected to the Input connector by sensing the amount of current flowing from the current sink through the probe coding resistance. The output of this circuit corrects the mainframe readout system to include the probe attenuation factor. The third contact of the Input connector provides the input to the probe sensing stage from the probe coding resistance (coded probes only; see Operating Instructions). The third contact is also used for the IDENTIFY input. The coding resistor forms a voltage divider with R621 through CR621 to the -15 V supply. The resultant voltage sets the bias on Q620 and determines, along with emitter resistor R622, the collector current. When the -15 volt time-slot pulse is applied to Interface Connector B33, Q620 is interrogated and its collector current is added to the Column current output through Interface Connector A37.

With a 1X probe (or no probe) connected to the Input connector, Q620 is turned off. The deflection factor readout is determined by the VOLTS/DIV switch position. With a 10X probe connected, the bias on Q620 will allow 100 microamperes of collector current to flow. This increases the deflection factor readout by a factor of 10.

The IDENTIFY button (S1465 on Diagram 2 or S2465 on Diagram 3) does two things when pressed:

1. It causes the trace representing the appropriate channel of the 7A24 to move about 0.3 division (see the Front-Panel Controls and Connectors, Figure 1-3).
2. It forward biases CR621 and Q620 to result in a sufficient amount of collector current which, when added to the Column current output, replaces the deflection factor readout with the word "IDENTIFY".

These two actions aid in identifying the 7A24 trace when multiple traces are displayed. When the IDENTIFY button is released, the deflection factor readout and trace position are restored.

Diodes CR1465 in CH 1, and CR2465 in CH 2 isolate readout circuitry from the position circuitry. For further information on the operation of the readout system, see the oscilloscope instruction manual.

MAINTENANCE

This section of the manual contains maintenance information for use in preventive maintenance, corrective maintenance, and troubleshooting of the 7A24.

Further maintenance information relating to general maintenance can be found in the instruction manuals for the 7000-series oscilloscopes.

PREVENTIVE MAINTENANCE

GENERAL

Preventive maintenance, consisting of cleaning, visual inspection, etc., performed on a regular basis, will improve the reliability of this instrument. Periodic checks of the semiconductor devices used in the unit are not recommended as a preventive maintenance measure.

CLEANING

CAUTION

Avoid the use of chemical cleaning agents which might damage the plastics used in this instrument. Use a non-residue type of cleaner, preferably isopropyl alcohol, totally denatured ethyl alcohol, or TP35. Before using any other type of cleaner, consult your Tektronix Service Center or representative.

FRONT PANEL

Loose dust may be removed with a soft cloth or a dry brush. Water and mild detergent may be used; however, abrasive cleaners should not be used.

INTERIOR

Cleaning the interior of the unit should precede electrical adjustment, since the cleaning process could alter the settings of the adjustments. Use low-velocity compressed air to blow off the accumulated dust. Hardened dirt can be removed with a soft dry brush, cotton-tipped swab, or cloth dampened with a mild detergent and water solution.

LUBRICATION

Use a cleaning-type lubricant on shaft bushings, interconnecting plug contacts, and switch contacts. Lubricate switch detents with a heavier grease. A lubrication kit containing the necessary lubricating materials and instructions is available through any Tektronix Field Office. Order Tektronix Part 003-0342-01. See Figure 4-1 for details.

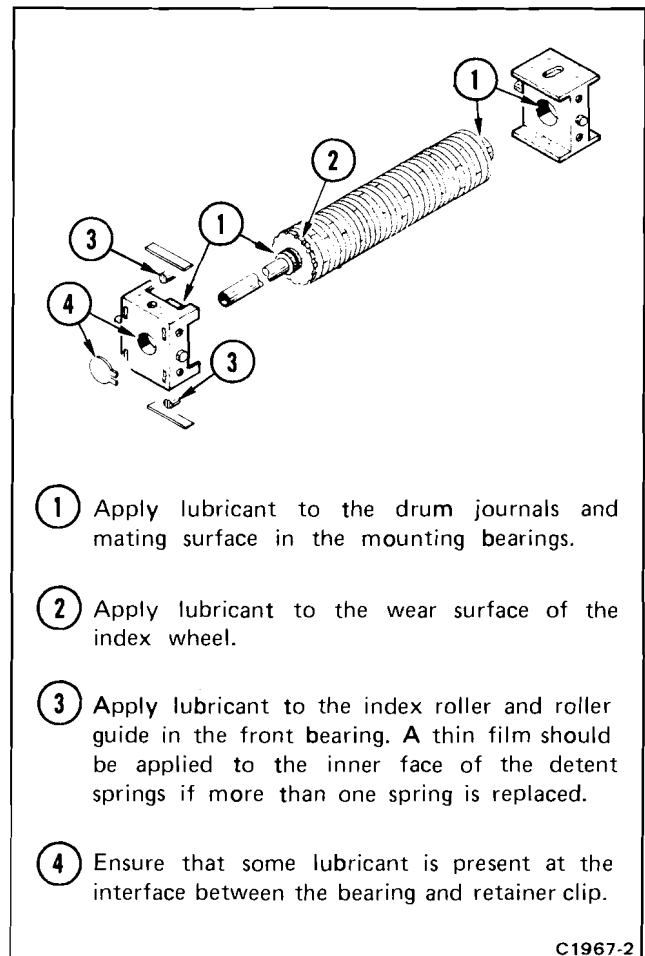
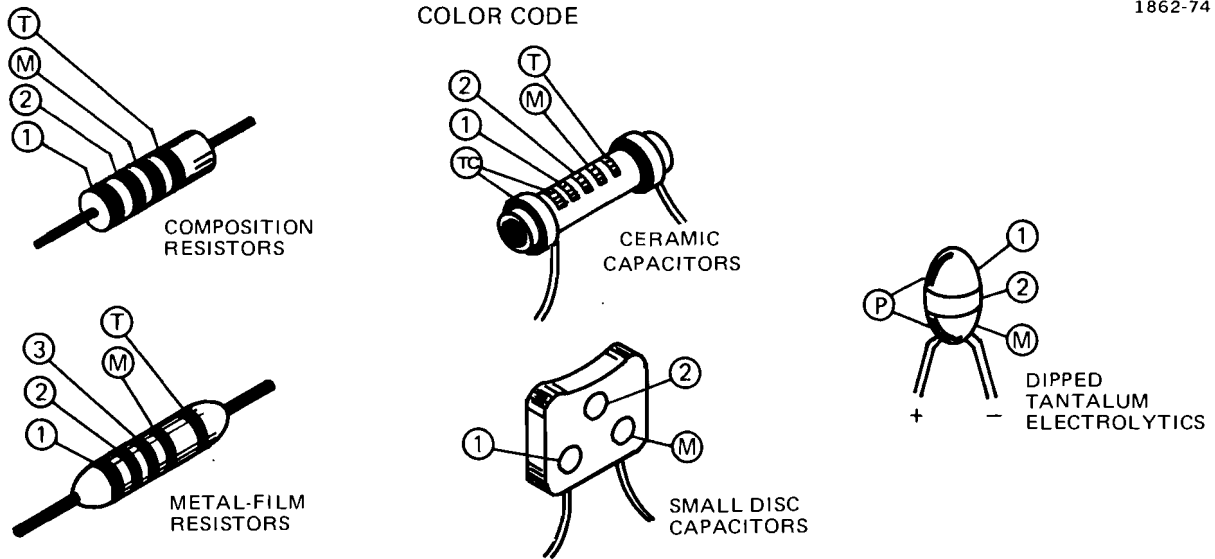

Figure 4-1. Lubrication procedure for a typical cam switch.



① ② and ③ - 1ST, 2ND, AND 3RD SIGNIFICANT FIGS. ① AND/OR ② COLOR CODE MAY NOT BE PRESENT ON SOME CAPACITORS;
 ④ - MULTIPLIER ⑤ - TOLERANCE;
 ⑥ - TEMPERATURE COEFFICIENT. ⑦ - POLARITY AND VOLTAGE RATING

COLOR	SIGNIFICANT FIGURES	RESISTORS		CAPACITORS			DIPPED TANTALUM VOLTAGE RATING
		MULTIPLIER (OHMS)	TOLERANCE	MULTIPLIER (pF)	TOLERANCE		
					OVER 10pF	UNDER 10pF	
BLACK	0	1	---	1	±20%	± 2pF	4VDC
BROWN	1	10	±1%	10	±1%	±0.1pF	6VDC
RED	2	10 ² or 100	±2%	10 ² or 100	±2%	---	10VDC
ORANGE	3	10 ³ or 1 K	±3%	10 ³ or 1000	±3%	---	15VDC
YELLOW	4	10 ⁴ or 10K	±4%	10 ⁴ or 10,000	+100% -0%	---	20VDC
GREEN	5	10 ⁵ or 100 K	±1/2%	10 ⁵ or 100,000	±5%	±0.5pF	25VDC
BLUE	6	10 ⁶ or 1 M	±1/4%	10 ⁶ or 1,000,000	---	---	35VDC
VIOLET	7	---	±1/10%	10 ⁷ or 10,000,000	---	---	50VDC
GRAY	8	---	---	10 ⁻² or 0.01	+80% -20%	±0.25pF	---
WHITE	9	---	---	10 ⁻¹ or 0.1	±10%	±1pF	3VDC
GOLD	---	10 ⁻¹ or 0.1	±5%	---	---	---	---
SILVER	---	10 ⁻² or 0.01	±10%	---	---	---	---
NONE	---	---	±20%	---	±10%	±1pF	---

Figure 4-2. Color code for resistors and capacitors.

TROUBLESHOOTING

GENERAL

The following is provided to augment information contained in other sections of this manual when troubleshooting the 7A24. The schematic diagrams, circuit description, and adjustment sections should be used to full advantage. The Theory of Operation section gives detailed information on circuit behavior and output requirements.

TROUBLESHOOTING AIDS

DIAGRAMS

Circuit diagrams are illustrated on foldout pages in Section 8, Diagrams and Circuit Board Illustrations. The circuit number and electrical value of each component in this instrument are shown on the diagrams. The circuit diagrams are blocked off according to circuit function as described in the Theory of Operation section.

CIRCUIT BOARDS

The circuit boards used in the 7A24 are outlined on the schematic diagrams, and illustrations of the boards are shown on the backs of preceding diagram pages. Each board-mounted electrical component is identified on the illustration by its circuit number.

COMPONENT AND WIRING COLOR CODE

Colored stripes or dots on resistors and capacitors signify electrical values, tolerances, etc., according to the EIA standard color code. See Figure 4-2. Components not color coded usually have the value printed on the body.

The insulated wires used for interconnection in the 7A24 are color coded to facilitate tracing wires from one point to another in the unit.

SEMICONDUCTOR LEAD CONFIGURATION

The lead configurations of the semiconductor devices used in this instrument are shown in Figure 4-3.

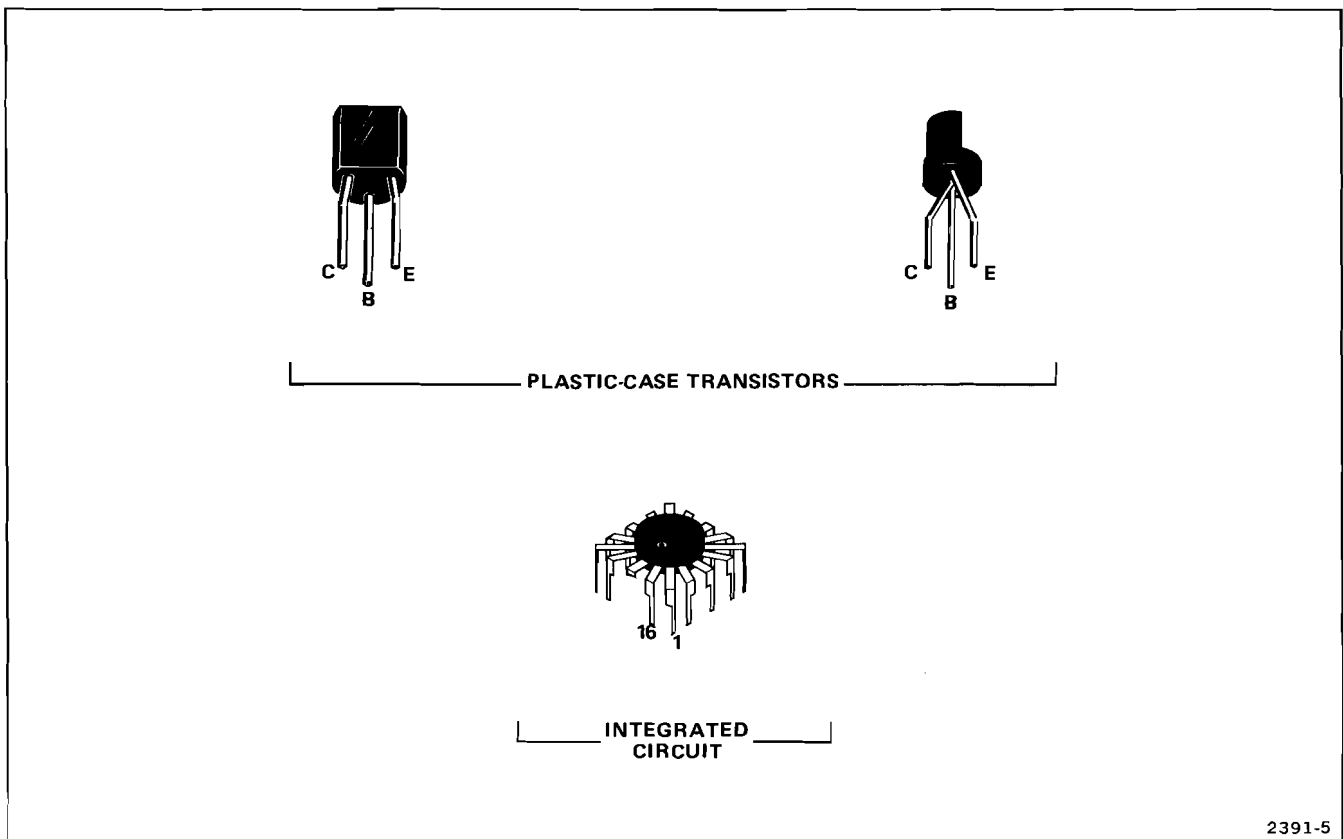

2391-5

Figure 4-3. Semiconductor electrode configurations.

Multi-Connector Holders

The multi-connector holders are keyed with two triangles, one on the holder and one on the circuit board. When a connection is made perpendicular to a circuit board surface, the orientation of the triangle on the end-lead multi-pin connector holder is determined by the placement of the multi-pin connector index, (see Fig. 4-4).

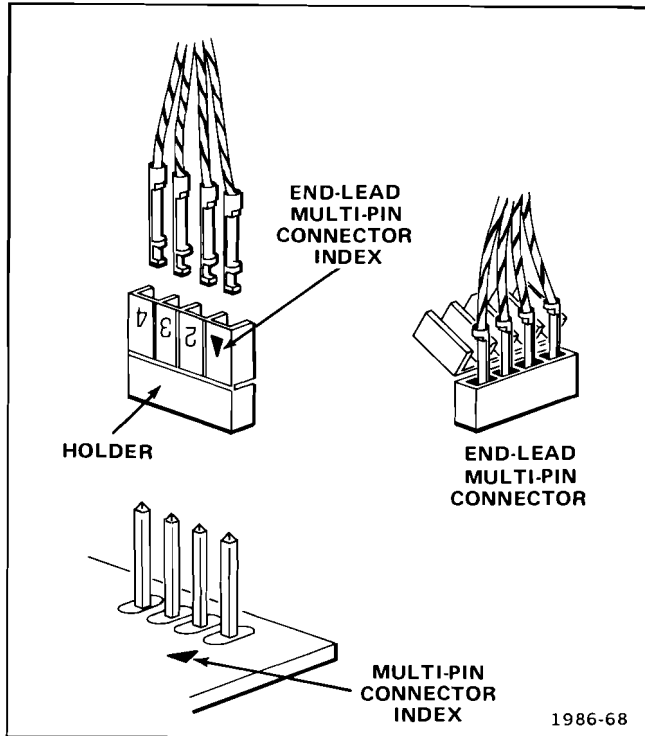

Figure 4-4. Orientation of multi-connector holders.

TROUBLESHOOTING CHART

A troubleshooting chart is given in Section 8, Diagrams and Circuit Board Illustrations to aid in locating a defective circuit. The shaded blocks on the Troubleshooting Chart indicate circuit(s) that may cause the indicated malfunction. The circuits listed are discussed in detail in Section 3, Theory of Operation.

TROUBLESHOOTING EQUIPMENT

The following equipment is useful for troubleshooting the 7A24.

1. Semiconductor Tester—Some method of testing the transistors and diodes used in this instrument is helpful. A transistor-curve tracer such as the Tektronix Type 576 will give the most complete information.

2. DC Voltmeter and Ohmmeter—A voltmeter is required for checking voltages within the circuits, and an ohmmeter for checking resistors and diodes.

3. Test Oscilloscope—A test oscilloscope is required to view waveforms at different points in the circuit. A Tektronix 7000-series mainframe equipped with a readout system, 7D13 Digital Multimeter unit, 7B-series time-base unit, and a 7A-series amplifier unit with a 10X probe will meet the needs of both items 2 and 3.

4. Plug-in Extender—A fixture that permits operation of the unit outside of the plug-in compartment for better accessibility during troubleshooting. Order Tektronix Part 067-0589-00.

TROUBLESHOOTING PROCEDURE

This troubleshooting procedure is arranged in an order which checks the simple trouble possibilities before proceeding with extensive troubleshooting.

1. CHECK CONTROL SETTINGS

An incorrect setting of the 7A24 controls can indicate a trouble that does not exist. If there is any question about the correct function or operation of a control or front-panel connector, see the Operating Instructions section.

2. CHECK ASSOCIATED EQUIPMENT

Before proceeding with troubleshooting of the 7A24 check that the equipment used with this instrument is operating correctly. If possible, substitute an amplifier unit known to be operating correctly into the mainframe and see if the problem persists. Check that the input signals are properly connected and that the interconnecting cables are not defective.

3. VISUAL CHECK

Visually check the portion of the instrument in which the trouble is suspected. Many troubles can be located by visual indications, such as unsoldered connections, broken wires, damaged circuit boards, damaged components, etc.

4. CHECK INPUT PROTECTION FUSE

If no waveform can be displayed, but the POSITION control will move the trace on the crt, check the condition of the input fuse. (See Component Replacement for fuse replacement instructions.)

5. CHECK INSTRUMENT PERFORMANCE

Check the adjustment of the unit or the affected circuit, by performing the Performance Check in section 5. The apparent trouble may only be a result of misadjustment, and may be corrected by readjustment. Complete adjustment instructions are given in section 5.

6. CHECK VOLTAGES AND WAVEFORMS

Often the defective component or stage can be located by checking the voltages or waveforms in the circuit. Typical voltages and waveforms are given in Section 8, Diagrams and Circuit Board Illustrations.

NOTE

Voltages and waveforms given in Section 8, Diagrams and Circuit Board Illustrations, are not absolute and may vary slightly between 7A24 Vertical Amplifiers. To obtain operating conditions similar to those used to take these readings, see the appropriate schematic.

7. CHECK INDIVIDUAL COMPONENTS

The following methods are provided for checking the individual components. Components which are soldered in place are best checked by disconnecting one end to isolate the measurement from the effects of surrounding circuitry.

A. Transistors

The best check of transistor operation is actual performance under operating conditions. If a transistor is suspected of being defective, it can best be checked by substituting a component known to be good; however, be sure that circuit conditions are not such that a replacement might also be damaged. If substitute transistors are not available, use a dynamic tester (such as Tektronix Type 576). Static-type testers may be used, but since they do not check operation under simulated operating conditions, some defects may go unnoticed. Be sure the power is off before attempting to remove or replace any transistor.

B. Diodes

A diode can be checked for an open or for a short circuit by measuring the resistance between terminals with an ohmmeter set to the R X 1k scale. The diode resistance should be very high in one direction and very low when the meter leads are reversed. Do not check tunnel diodes or back diodes with an ohmmeter.

CAUTION

Do not use an ohmmeter scale that has a high internal current. High currents may damage the diodes.

C. Resistors

Check resistors with an ohmmeter. Resistor tolerance is given in the Electrical Parts List. Resistors normally do not need to be replaced unless the measured value varies widely from the specified value.

D. Capacitors

A leaky or shorted capacitor can be detected by checking resistance with an ohmmeter on the highest scale. Use an ohmmeter which will not exceed the voltage rating of the capacitor. The resistance reading should be high after initial charge of the capacitor. An open capacitor can best be detected with a capacitance meter, or by checking whether the capacitor passes ac signals.

E. Fuses

The Input Protection Fuse can be checked by measuring the resistance from the center conductor of the input BNC connector to ground (plug-in frame). This resistance should be approximately 50 ohms. If the input appears open, replace the fuse. (See Component Replacement for fuse replacement instructions.)

F. Attenuators

The thick film attenuators are best checked by substitution. If only one channel of the 7A24 is not operating properly, and there is reason to believe an attenuator is defective, replace the suspected attenuator with the same attenuator from the other channel and check instrument operation. If proper operation results, order a new attenuator. (See Component Replacement for replacement instructions.)

8. REPAIR AND READJUST THE CIRCUIT

Special techniques required to replace components in this unit are given under Component Replacement. Be sure to check the performance of any circuit that has been repaired or that has had any electrical components replaced. Recalibration of the affected circuit may be necessary.

CORRECTIVE MAINTENANCE

GENERAL

Corrective maintenance consists of component replacement and instrument repair. Special techniques required to replace components in this instrument are given here.

OBTAINING REPLACEMENT PARTS

STANDARD PARTS

All electrical and mechanical part replacements for the 7A24 can be obtained through your local Tektronix Field Office or representative. However, many of the electronic components can be obtained locally in less time than is required to order them from Tektronix, Inc. Before purchasing or ordering replacement parts, check the parts list for value, tolerance, rating and description.

NOTE

When selecting replacement parts, it is important to remember that the physical size and shape of a component may affect the performance of the instrument, particularly at high frequencies. All replacement parts should be direct replacements unless it is known that a different component will not adversely affect instrument performance.

SPECIAL PARTS

In addition to the standard electronic components, some special parts are used in the 7A24. These parts are manufactured or selected by Tektronix, Inc. in accordance with our specifications. Most of the mechanical parts used in this instrument have been manufactured by Tektronix, Inc. Order all special parts directly from your local Tektronix Field Office or representative.

ORDERING PARTS

When ordering replacement parts from Tektronix, Inc., include the following information:

1. Instrument Type.
2. Instrument Serial Number.
3. A description of the part (if electrical, include circuit number).
4. Tektronix Part Number.

SOLDERING TECHNIQUES

WARNING

To avoid electric-shock hazard, disconnect the instrument from the power source before soldering.

The following rules should be observed when removing or replacing parts:

1. Use a low-wattage soldering iron (not over 15 watts).
2. Do not apply more heat, or apply heat for a longer time, than is absolutely necessary.
3. Use some form of vacuum solder remover when removing multi-lead devices.
4. Do not apply any solvent containing ketones, esters or halogenated hydrocarbons.
5. To clean, use only water-soluble detergents, ethyl, methyl, or isopropyl alcohol.

CIRCUIT BOARDS

The components mounted on the circuit boards in the amplifier can be replaced using normal circuit board soldering techniques.

CAUTION

The A5—Amplifier circuit board is a multi-layer type board with a conductive path laminated between the top and bottom board layers. All soldering on this board should be done with extreme care to prevent breaking the connections to this center conductor. Only experienced maintenance personnel should attempt repair of this board.

Keep the following points in mind when soldering on the circuit boards:

1. Use a low-wattage, pencil-type soldering iron.
2. Apply heat from the soldering iron to the junction between the component and the circuit board.
3. Heat-shunt the lead to the component by means of a pair of long-nose pliers.
4. Avoid excessive heating of the junction with the circuit board, as this could separate the circuit board wiring from the base material.
5. Use electronic grade 60-40 tin-lead solder.
6. Clip off any excess lead length extending beyond the circuit board. Clean off any residual flux with a flux-removing solvent.

METAL TERMINALS

When soldering metal terminals (e.g. potentiometers, etc.) use 60-40 tin-lead solder and a 15 to 50 watt soldering iron. Observe the following precautions when soldering metal terminals:

1. Apply only enough heat to make the solder flow freely.
2. Apply only enough solder to form a solid connection. Excess solder may impair the function of the part.
3. If a wire extends beyond the solder joint, clip off the excess.
4. Clean the flux from the solder joint with a flux-removing solvent.

COMPONENT REPLACEMENT

WARNING

To avoid electric-shock hazard, disconnect the equipment from the power source before replacing components.

FUSE AND ATTENUATOR REPLACEMENT

To remove fuses or attenuators, press down on both ends of the spring clip and push the clip toward the bottom of circuit board until the clip disengages from the studs. Remove the clip and lift the ceramic fuse or attenuator straight up and off the board. Be careful not to damage the cam switch contacts.

When reinstalling fuses or attenuators, align the ceramic with the open end toward the bottom of the 7A24. Be careful not to damage the thick film with the mounting studs. Slide the open end of the clip under the top stud and align the large bottom hole with the bottom stud. Press down on both ends of the spring clip and push upward until the clip snaps into position.

SEMICONDUCTOR REPLACEMENT

Transistors should not be replaced unless actually defective. If removed from their sockets during routine maintenance, return them to their original sockets. Unnecessary replacement of transistors may affect the adjustment of this instrument. When transistors are replaced, check the performance of the part of the instrument which may be affected.

Replacement semiconductors should be of the original type or a direct replacement. The lead configurations of the semiconductors used in this instrument are shown in Figure 4-3. If the replacement semiconductor is not of the original type, check the manufacturer's basing diagram for proper basing.

CIRCUIT BOARD REMOVAL

In general, the circuit boards used in the 7A24 need never be removed unless they must be replaced. Electrical connections to the boards are made by soldered connections. If it is necessary to replace a circuit board assembly, use the following procedures.

A. Readout Circuit Board Removal

1. Disconnect the wires connected to the front of the board.
2. Remove the screws holding the board to the mounting surface.
3. Disconnect the wires connected to the back of the board.
4. Remove the board from the unit.
5. To replace the board, reverse the order of removal.

B. Attenuator Circuit Board Removal

1. Remove six screws holding Readout board to the cam switch attenuator and one screw holding the rear of the Readout board to the Amplifier board. Position the Readout board out of the way, being careful not to damage the cam switch contacts.
2. Disconnect the coaxial jumper and mounting bracket from the rear of the board.
3. Disconnect the input cable from the rear of the input BNC connector.
4. Loosen the front set screw on the VARIABLE control shaft coupling (use a 0.050-inch hex-key wrench).
5. Remove the red VARIABLE control knob and fiberglass rod from the control shaft.
6. Remove the VOLTS/DIV, and POSITION knobs using a 1/16-inch hex-key wrench. (The IDENTIFY knob will pull off with the POSITION knob.)
7. Remove the input BNC connector, POSITION control and the Coupling knob.
8. Remove the two screws from the bracket on the rear of the board.
9. Remove the attenuator board with cam switch from the instrument.
10. Replace by reversing the removal procedure.

C. Amplifier Circuit Board Removal

1. Remove the plastic plug-in guide from the rear of the instrument.

Maintenance—7A24 (SN B103000 & UP)

2. Disconnect the wires connected to the Amplifier board and Readout boards.
3. Loosen the hex-socket screws in both the TRIGGER SOURCE and DISPLAY MODE knobs. Remove knobs.
4. Disconnect the coaxial jumper and mounting bracket from the front of the board.
5. Remove the screws and nuts securing the board to the chassis or other mounting surfaces.
6. Remove the board from the instrument.
7. To replace, reverse the order of removal.

INTERCONNECTING PINS

Two methods of interconnection are used in this instrument to electrically connect the circuit boards with other boards and components. When the interconnection is made with a coaxial cable, a special end-lead connector plugs into a mating socket on the board. Other interconnections are made with a pin soldered into the board. Two types of mating connectors are used for these interconnecting pins. If the mating connector is mounted on a plug-on circuit board, a special socket is soldered into the board. If the mating connector is on the end of a lead, an end-lead pin connector is used which mates with the interconnecting pin. The following information provides the removal and replacement procedure for the various types of interconnecting methods.

Coaxial-Type End-Lead Connectors

Replacement of the coaxial-type end-lead connectors requires special tools and techniques; only experienced maintenance personnel should attempt to remove or replace these connectors. We recommend that the damaged cable or wiring harness be replaced as a unit. For cable or wiring harness part numbers, see Section 9, Replaceable Mechanical Parts. An alternative solution is to refer the replacement of the defective connector to your local Tektronix Field Office or representative. Figure 4-5 gives an exploded view of a coaxial end-lead connector assembly.

Circuit-Board Pins

A circuit-board pin replacement kit (including necessary tools, instructions, and replacement pins with attached ferrules) is available from Tektronix, Inc. Order Tektronix Part 040-0542-00. Replacing circuit-board pins on multi-layer boards is not recommended. (The multi-layer boards in this instrument are listed under Soldering Techniques in this section.)

To replace a damaged pin, first disconnect any pin connectors. Then unsolder the damaged pin and pull it from the board with a pair of pliers, leaving the ferrule (see Figure 4-6) in the circuit board if possible.

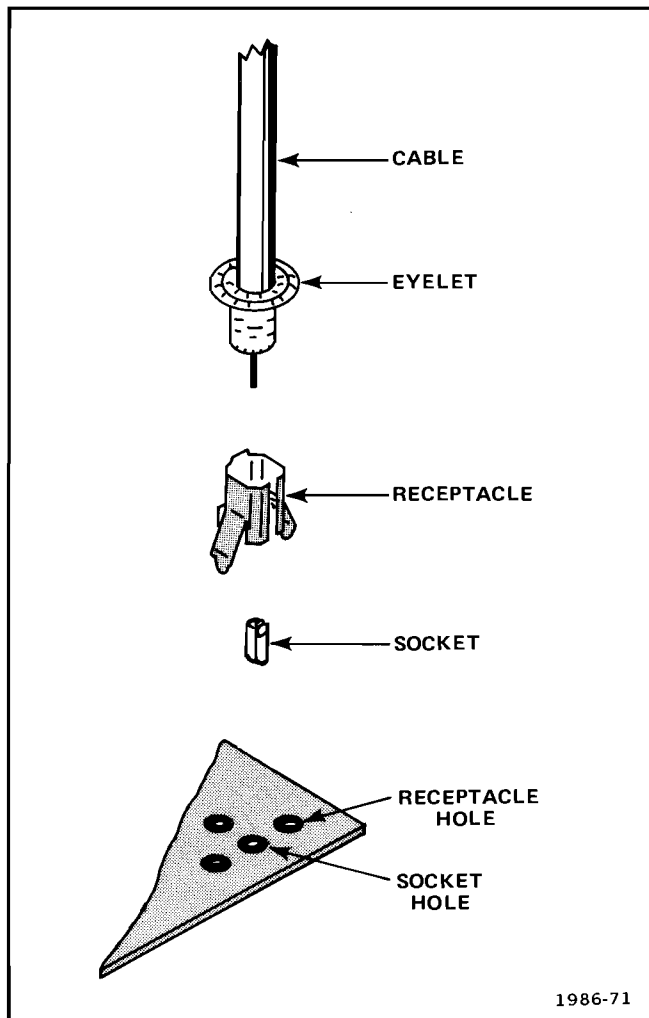

Figure 4-5. Coaxial end-lead connector assembly.

If the ferrule remains in the circuit board, remove the spare ferrule from the circuit board. If the ferrule is removed with the damaged pin, clean out the hole using a solder-removing wick and a scribe. Then press the replacement pin, with attached spare ferrule, into the circuit board. Position the replacement pin in the same manner as the original pin had been. Solder the pin to the circuit board on each side of the board. If the original pin was bent at an angle to mate with a connector, carefully bend the new pin to the same angle. Replace the pin connector.

SWITCH REPLACEMENT

The following special maintenance information is provided for the cam-type switches.

CAUTION

Repair of cam-type switches should be undertaken only by experienced maintenance personnel. Switch alignment and spring tension of the contacts must be carefully maintained for proper operation of the switch. For this reason, it is recommended that the switch assembly be replaced as a unit. For assistance in maintenance of cam-type switches, contact your local Tektronix Field Office or representative.

A. Cam-Type Switches

A cam-type switch consists of a rotating cam, which is turned by the front-panel knobs, and a set of contacts mounted on an adjacent circuit board. These switch contacts are actuated by lobes on the cam. The VOLTS/DIV and Coupling cam-type switches can be disassembled for inspection, cleaning, repair, or replacement as follows:

1. Remove the Readout board and the Attenuator board/switch assembly as described previously. The front switch section on the Attenuator board is the Coupling switch and the rear switch section is the VOLTS/DIV switch. The switches are now open for inspection or cleaning.
2. To completely remove the switch from the board, remove the two screws and two hexagonal posts which hold the cam-type switch to the circuit board.
3. To remove the cam from the front support block, remove the retaining ring from the shaft on the front of the switch and slide the cam out of the support block. Be careful not to lose the small detent roller.
4. To replace defective switch contacts, follow the instructions given in the switch repair kit.
5. To reinstall the switch assembly, reverse the above procedure.

READJUSTMENT AFTER REPAIR

After any electrical component has been replaced, the adjustment of that particular circuit should be checked, as well as the adjustment of other closely related circuits. Refer to section 5 for these procedures.

REPACKAGING FOR SHIPMENT

If the Tektronix instrument is to be shipped to a Tektronix Service Center for service or repair, attach a tag showing: Owner (with address) and the name of an individual at your firm that can be contacted, complete instrument serial number, and a description of the service required.

Save and re-use the package in which your instrument was shipped. If the original packaging is unfit for use or not available, repackage the instrument as follows:

Surround the instrument with polyethylene sheeting to protect the finish of the instrument. Obtain a carton of corrugated cardboard of the correct carton strength and having inside dimensions of no less than six inches more than the instrument dimensions. Cushion the instrument by tightly packing three inches of dunnage or urethane foam between carton and instrument, on all sides. Seal carton with shipping tape or industrial stapler.

The carton test strength for your instrument is 200 pounds.

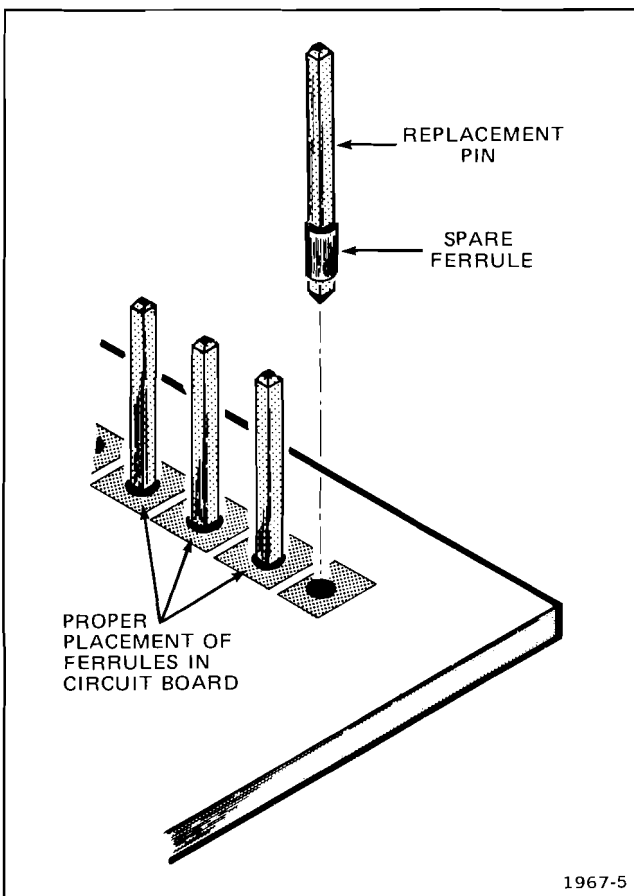

Figure 4-6. Exploded view of circuit-board pin and ferrule.

PERFORMANCE CHECK AND ADJUSTMENT

PRELIMINARY INFORMATION

ADJUSTMENT INTERVAL

To ensure instrument accuracy, check the adjustment of the 7A24 every 1000 hours of operation, or every six months if used infrequently. Before complete adjustment, thoroughly clean and inspect this instrument as outlined in the Maintenance section of the manual.

TEKTRONIX FIELD SERVICE

Tektronix, Inc. provides complete instrument repair and readjustment at local Field Service Centers and the Factory Service Center. Contact your local Tektronix Field Office or representative for further information.

USING THIS PROCEDURE

This Performance Check and Adjustment procedure can be used for a complete adjustment procedure or as a check of the instrument's performance. Completion of each step in the procedure ensures that the instrument is correctly adjusted and operating within specified limits. Refer to the following discussion for instructions on a complete or partial check and adjustment.

Index

An index precedes the procedure to aid in locating Performance Check and Adjustment steps.

Performance Check

Instrument performance can be checked by performing the complete Performance Check and Adjustment procedure and omitting the ADJUST parts of the steps. A check mark \checkmark preceding a CHECK indicates that the limit given is a performance requirement specified in Section 2, Specification.

Adjustment

Completion of each step in the Performance Check and Adjustment procedure ensures that the instrument is correctly adjusted and performing within specified limits. Where possible, instrument performance is checked before an adjustment is made. For best overall performance when performing the complete adjustment procedure, make each adjustment to the exact setting indicated.

Partial Procedures

The following procedure is written to completely check and adjust the instrument to the Performance Requirements listed in Section 2, Specification. If the applications for which the instrument is used do not require the full available performance, the procedures and the required equipment list can be shortened accordingly.

A partial performance check and adjustment may be desirable after replacing components, or to touch up the adjustment of a portion of the instrument. To check or adjust only part of the instrument, refer to the Equipment Required list which precedes that portion of the procedure to be performed. To avoid unnecessary adjustment of other parts, adjust only if the tolerance given in the CHECK step is not met.

TEST EQUIPMENT REQUIRED

The following test equipment and accessories, or its equivalent, are required for complete adjustment of the 7A24. Specifications given for the test equipment are the minimum necessary for accurate adjustment. Therefore, some of the specifications listed here may differ from the actual performance capabilities of the test equipment. All test equipment is assumed to be correctly adjusted and operating within the listed specifications. Detailed operating instructions for the test equipment are not given in this procedure. Refer to the instruction manual for the test equipment if more information is needed.

If only a Performance Check procedure is performed, not all of the listed test equipment will be required. Items used only for the Adjustment procedures are indicated by footnote 1. The remaining pieces of equipment are items common to both the Performance Check and the Adjustment Procedure.

SPECIAL CALIBRATION FIXTURES

Special fixtures are used only where they facilitate instrument adjustment. These special fixtures are available from Tektronix, Inc. Order by part number through your local Tektronix Field Office or representative.

TEST EQUIPMENT ALTERNATIVES

All of the listed test equipment is required to completely check and adjust this instrument. However, complete checking or adjustment may not always be necessary. The user may be satisfied with checking only selected characteristics, thereby reducing the amount of test equipment required.

The Performance Check and Adjustment Procedure is based on the first item of equipment given as an example of applicable equipment. When other equipment is substituted, control settings or adjustment setup may need to be altered to meet the requirements of the substitute equipment. If the exact item of test equipment given as an example in the Test Equipment list is not available, first check the Specifications column carefully to see if any other equipment is available which might suffice. Then check the Usage column to see what this item is used for. If used for a check or adjustment that is of little or no importance to your measurement requirements, the item and corresponding step(s) can be deleted.

TABLE 5-1
Test Equipment

Description	Minimum Specifications	Usage	Examples
1. Test Oscilloscope	Tektronix 7000-series. 200 MHz bandwidth required for complete procedure.	Used throughout the procedures to provide display.	a. TEKTRONIX 7704A Oscilloscope System.
2. Time Base Plug-In Unit	Tektronix 7B-series time-base unit. Fastest sweep 20 ns required for complete procedure.	Used throughout the procedure to provide sweep.	a. TEKTRONIX 7B80 Time Base.
3. Amplifier Plug-In Unit ¹	Tektronix 7A-series Differential Amplifier unit. Sensitivity, at least 0.5 mV/div.	Used for Input Resistance Check and Adjust.	a. TEKTRONIX 7A22 Differential Amplifier.
4. 50-Ohm Amplitude Calibrator	Amplitude accuracy, within 0.25% range, 30 mV to 2 V into 50 Ohms; frequency 1 kHz.	Used for Gain Check and Adjust Mode, Trigger Source Checks.	a. TEKTRONIX PG506 Calibration Generator.
5. Square Wave Generator	Rise-time, 1.0 ns or less; Amplitude, 100 mV or less to 1.0 V.	Used for Low Frequency Compensation Check and Adjust.	a. TEKTRONIX PG506 Calibration Generator.
6. Fast-Rise Pulse Generator	Amplitude, 200 mV; Rise-time, less than 100 picoseconds; Aberration, less than 1%.	Used for High Frequency Compensation Check and Adjust.	a. TEKTRONIX Type 284 Pulse Generator.
7. Medium Frequency Signal Generator.	Frequency range to at least 50 MHz; reference frequency, 50 kHz, output amplitude, at least 50 millivolts into 50 Ohms; amplitude accuracy, within 3%.	Used for Common Mode Rejection Ratio Check, Display Mode, Trigger Source Checks, and High Frequency Checks, adjustments.	a. TEKTRONIX SG503 Leveled Sine Wave Generator. b. General Radio 1211-C with 1263-C Amplitude Regulating Power Supply.
8. High Frequency Signal Generator	Frequency Range, to at least 450 MHz; reference frequency, 3 MHz; output amplitude, at least 3 volts into 50 Ohms; amplitude accuracy, within 5%.	Used for Bandwidth Check.	a. TEKTRONIX SG504 Leveled Sine Wave Generator. b. General Radio 1362 with 1263-C Amplitude Regulating Power Supply.
9. Sampling Unit (two required)	Deflection Factor, 2 mV to 200 mV/div.	Used for High Frequency Check and Adjustment.	a. TEKTRONIX 7S11 Sampling Unit.
10. Sampling Head (two required)	Rise-time, 75 ps or less; Displayed noise, 6 mV or less.	Used with Sampling unit.	a. TEKTRONIX S-2 Sampling Head.
11. Sampling Time Base	Time/Div, 10 ps to 5 ms; 3% accuracy.	Used for High Frequency Check and Adjustment.	a. TEKTRONIX 7T11 Sampling Sweep Unit.

¹Any method of accurately (plus or minus 0.5%) measuring resistance may be substituted for this piece of equipment and the test circuit shown in Figure 5-1.

TABLE 5-1 (CONTINUED)

Test Equipment

Description	Minimum Specifications	Usage	Examples
12. Signal Generator Main-frame	Tektronix TM-500 series, accepts three plug-ins.	Used with TM-500 series signal generators.	a. TEKTRONIX TM-503.
13. Signal Pickoff	Sensitivity, 10% into 50 ohms; Rise-time, 0.4 ns or less, Frequency Response, 50 kHz to at least 500 MHz.	Used for High Frequency Checks and Adjustments.	a. TEKTRONIX CT3 Signal Pickoff.
14. Signal Pickoff	Connects between 7A24 and flexible extender.	Used for High Frequency Checks and Adjustments.	a. TEKTRONIX Calibration Fixture 067-0655-00.
15. Plug-In Extender ²	Flexible plug-in extender for 7000-series plug-ins.	Used for High Frequency Checks and Adjustments.	a. TEKTRONIX Calibration Fixture 067-0616-00.
16. VSWR Test Fixture	Frequency Range, to at least 450 MHz; Insertion Loss, 6 dB or less; BNC fittings.	Used for VSWR Check.	a. Wiltron 67BF50 VSWR Autotester.
17. Plug-In Extender ²	Rigid plug-in extender for 7000-series plug-ins.	Used for Trigger adjustments and checks.	a. TEKTRONIX Calibration Fixture 067-0589-00.
18. Cable (two required)	Connectors, BNC; impedance, 50 Ohms; length 42 inches, 9 inches.	Used throughout the procedures.	a. Tektronix Part 012-0057-01.
19. Cable	Connectors, BNC, 50-Ohm Precision, 36 inches.	Used for Bandwidth Check.	a. Tektronix Part 012-0482-00.
20. Adapter	BNC to SMA.	Used for High Frequency Checks and Adjustments.	a. Tektronix Part 015-1018-00.
21. Adapter	BNC male to GR.	Used with 284, SG503, SG504, and PG506.	a. Tektronix Part 017-0064-00.
22. Adapter	BNC female to GR.	Used with High Frequency Signal Generator (SG504).	a. Tektronix Part 017-0063-00.
23. 5X Attenuator, 10X Attenuator	Connectors, BNC; impedance 50 Ohms.	Used with Fast-Rise Pulse Generator (284), Signal Generator (PG506), and VSWR.	a. Tektronix Part 011-0060-02.
24. Dual-Input Coupler	Connectors, BNC; matched signal transfer to each input.	Used for Common Mode Rejection Ratio Check.	a. TEKTRONIX Calibration Fixture 067-0525-01.
25. Screwdriver ²	Three inch shaft, 3/32-inch blade.	Used for adjusting potentiometers.	a. Xcelite R-3323.
26. Low-Capacitance Screwdriver ²	1 1/2-inch shaft.	Used for adjusting variable capacitors.	a. Tektronix Part 003-0000-00.

²Used for calibration only; NOT used for performance check.

PRELIMINARY PROCEDURE

The following procedure checks and adjusts the 7A24 to meet the performance requirements given in the Specifications section.

NOTE

The performance of this instrument can be checked at any ambient temperature from 0° to 50° C unless otherwise stated. Adjustments must be performed at an ambient temperature from +20° to +30° C for specified accuracies.

NOTE

Titles for front-panel controls of the 7A24 are capitalized in this procedure (e.g. VOLTS/DIV). Internal adjustments are initial capitalized (e.g. Invert Gain).

CAUTION

Turn off the mainframe power before installing or removing the plug-in units to prevent instrument damage.

1. Remove left side covers from the 7A24 and the test oscilloscope (only if the Adjustment Procedure is to be performed).
2. Insert the 7A24 into the test oscilloscope Left Vertical compartment.
3. Insert the differential amplifier plug-in unit into the Right Vertical compartment.
4. Insert the time-base plug-in unit into a horizontal compartment.

5. Set the 7A24 front panel controls as follows:

CH 1 and CH 2
POSITION.....midrange
CH 1 and CH 2
VOLTS/DIV.....5 mV
CH 1 and CH 2
VARIABLE VOLTS/DIV.....CAL IN
CH 1 and CH 2
Coupling.....DC
CH 2 POLARITY.....+UP
DISPLAY MODE.....CH 1
TRIGGER SOURCE.....MODE

6. Apply power and allow at least 20 minutes warm-up before proceeding.

INDEX TO PERFORMANCE CHECK AND ADJUSTMENT PROCEDURE

LOW FREQUENCY PROCEDURE.....	5-5
1. Check Readout and IDENTIFY	5-5
✓ 2. Check/Adjust Input Resistance.....	5-5
3. Adjust Offset Current.....	5-6
4. Adjust 2X Balance.....	5-6
5. Adjust DC Balance	5-6
✓ 6. Check/Adjust Gain.....	5-6
7. Adjust CH 2 Invert Gain Match.....	5-7
8. Check TRIGGER SOURCE and DISPLAY MODE Operation.....	5-7
9. Adjust Low Frequency Compensation.....	5-8
HIGH FREQUENCY PROCEDURE	5-8
10. Adjust High Frequency Compensation.....	5-8
11. Adjust Trigger High Frequency Compensation.....	5-10
12. Check Bandwidth.....	5-10
✓ 13. Check Common Mode Rejection Ratio	5-10
✓ 14. Check Input VSWR.....	5-11

✓Performance Requirement check; see introductory information.

LOW FREQUENCY PROCEDURE

Equipment Required

- | | |
|-----------------------------|--------------------------------|
| 1. Test Oscilloscope | 6. 50-ohm Amplitude Calibrator |
| 2. Time Base Plug-In Unit | 7. Square-Wave Generator |
| 3. Amplifier Plug-In Unit | 8. Signal Generator Mainframe |
| 4. Test Circuit (Fig. 5-1) | 9. Cable (50-ohm) |
| 5. Plug-In Extender (Rigid) | 10. Screwdriver |

BEFORE YOU BEGIN, see **ADJUSTMENT LOCATIONS** in the Diagrams section.

1. CHECK READOUT AND IDENTIFY OPERATION

- Set the DISPLAY switch to ALT.
- Rotate both VOLTS/DIV switches through their range.
- Check the Channel 1 (upper) crt readout should correspond to the CH 1 VOLTS/DIV switch settings, and the Channel 2 (lower) readout should correspond to the CH 2 VOLTS/DIV switch settings for all switch positions.
- Press the CH 1 IDENTIFY button.
- Check that the Channel 1 readout is replaced by the word "IDENTIFY" and the Channel 1 trace moves up 0.2 to 0.4 division.
- Release the CH 1 IDENTIFY button.
- Repeat parts d, e, and f, substituting CH 2 controls.

✓ 2. CHECK/ADJUST INPUT RESISTANCE (DC, $50 \Omega \pm 1.0 \text{ Ohms}$)

- Set the test oscilloscope to display the differential amplifier plug-in unit's output.
- Connect the test circuit, as shown in Figure 5-1, to the CH 1 input connector.
- Connect the test circuit outputs to the + and - inputs of the differential amplifier plug-in unit.
- Set the differential amplifier plug-in for 0.5 mV per division, ac coupled.
- Set both VOLTS/DIV switches to 5 mV.
- Set the CH 1 Coupling switch to DC.
- CHECK—The display should be 0.6 divisions or *0.3mV* less.
- ADJUST—The CH 1 Input R (R1305) for minimum display amplitude.

✓Performance Requirement check; see introductory information.

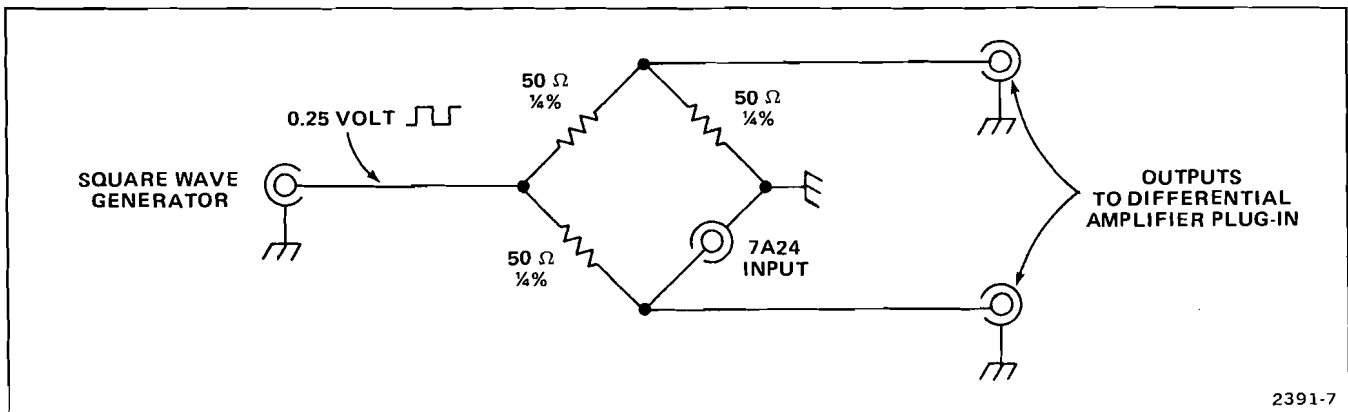

Figure 5-1. Test circuit for Input Resistance Check/Adjust step.

Performance Check and Adjustment—7A24 (SN B103000 & UP)

- i. Remove the test circuit from the CH 1 input.
- j. Connect the test circuit to the CH 2 input.
- k. Repeat parts f through i, substituting CH 2 controls (R2305).

3. ADJUST OFFSET CURRENT (0.5 DIVISION, MAXIMUM TRACE SHIFT)

- a. Set the test oscilloscope to display the 7A24 output.
- b. Set the DISPLAY MODE switch to CH 1.
- c. Set the CH 1 POSITION control to center the trace on the graticule.
- d. Check for a trace shift of not more than 0.5 division vertically while switching the CH 1 Coupling switch between the OFF and DC positions.
- e. Adjust the CH 1 Offset Null (R1301) for minimum trace shift.
- f. Repeat parts b through e, substituting CH 2 controls (R2301).

4. ADJUST 2X BALANCE (0.5 DIVISION, MAXIMUM TRACE SHIFT)

- a. Set the DISPLAY MODE switch to CH 1.
- b. Check for a trace shift of not more than 0.5 division vertically while switching the CH 1 VOLTS/DIV between the 5 mV and 10 mV positions.
- c. Adjust the CH 1 2X Bal (R1310) for minimum trace shift.
- d. Repeats parts a, b, and c, substituting CH 2 controls (R2310).

5. ADJUST DC BALANCE (0.5 DIVISION, MAXIMUM TRACE SHIFT)

- a. Set the DISPLAY MODE switch to CH 1.
- b. Engage the CH 1 VARIABLE VOLTS/DIV by pushing in and releasing the knob.
- c. Check for a trace shift of not more than 0.5 division while rotating the CH 1 VARIABLE from fully clockwise to fully counterclockwise.
- d. Adjust the CH 1 DC Bal (R1410) for minimum trace shift.

- e. Set DISPLAY MODE switch to CH 2.
- f. Reset the CH 1 VARIABLE to the CAL IN position.
- g. Adjust CH 2 DC Bal, (R2410) for minimum trace shift while switching from +UP to INVERT.
- h. Return control to +UP.
- i. Check for a trace shift of not more than 0.5 division while rotating the CH 2 VARIABLE from fully clockwise to fully counterclockwise.
- j. Set DISPLAY MODE switch to CH 1.

✓ 6. CHECK/ADJUST GAIN ($\pm 2\%$).

- a. Set both VOLTS/DIV switches to 10 mV.
- b. Connect a 50 mV signal from the 50-ohm Amplitude Calibrator to the CH 1 input.
- c. CHECK—The Display should be five divisions in amplitude, within 2% (0.1 division).
- d. ADJUST—The CH 1 GAIN by pushing in on the knob with a screwdriver and turning it until the control engages. Set the CH 1 GAIN for exactly five divisions of display amplitude (R1432B).
- e. NOTE—If the CH 1 GAIN cannot be adjusted for five divisions of display, it will be necessary to adjust the Channel 1 Internal Gain (R1332). To do this, set the front panel CH 1 Gain to the center of its range and adjust the Channel 1 Internal Gain for as close to five divisions of display amplitude as possible. Repeat step d.
- f. Set the CH 1 GAIN knob to the VARIABLE (out) position and turn fully counterclockwise.
- g. CHECK—The display amplitude should be two divisions or less.
- h. Set the CH 1 VARIABLE to the CAL IN position.
- i. CHECK—Using Table 5-2, check that gain is within $\pm 2\%$ for all positions of the CH 1 VOLTS/DIV switch.
- j. Remove the connection from the CH 1 input.
- k. Repeat parts b through j, substituting CH 2 controls (R2432B and R2332).

✓Performance Requirement check; see introductory information.

TABLE 5-2
Attenuator Accuracy

VOLTS/DIV Switch Setting	50 Ohm Amplitude Calibrator (PG506)	Vertical Deflection (divisions)	Maximum Error (divisions)
5 mV	50 mV	5	0.1
10 mV	100 mV	5	0.1
20 mV	200 mV	5	0.1
50 mV	500 mV	5	0.1
0.1 V	1 V	5	0.1
0.2 V	2 V	5	0.1
0.5 V	5 V	5	0.1
1 V	10 V	5	0.1

NOTE: PG506 output is one half of dial setting into 50 ohms.

7. ADJUST CH 2 INVERT GAIN MATCH (WITHIN 1%)

- a. Set the DISPLAY MODE switch to CH 2.
- b. Connect a 50 mV signal from the 50-ohm Amplitude Calibrator to the CH 2 input.
- c. Set the CH 2 VOLTS/DIV switch to 10 mV.
- d. Set the CH 2 POLARITY switch to INVERT.
- e. Check—The display amplitude should be within 1% of the +UP mode.
- f. Adjust—The Invert Gain (R2434) for minimum amplitude change while switching between the INVERT and +UP positions.
- g. Reset the CH 2 POLARITY switch to the +UP position.
- h. Recheck the CH 2 GAIN for five divisions of display amplitude and reset if necessary.

8. CHECK TRIGGER SOURCE AND DISPLAY MODE OPERATION

- a. Set both VOLTS/DIV switches to 10 mV.
- b. Set the DISPLAY MODE switch to ALT.
- c. Connect a 50-kHz signal from the medium-frequency signal generator to the CH 2 input and set the generator for three divisions of display.
- d. Connect a 50 mV signal from the 50-ohm Amplitude Calibrator to the CH 1 input.

- e. Set the TRIGGER SOURCE switch to CH 1.
- f. Check that both signals are displayed, but only the square wave is triggered.
- g. Set the TRIGGER SOURCE switch to MODE.
- h. Check that both signals are displayed and triggered.
- i. Set the TRIGGER SOURCE switch to CH 2.
- j. Check that both signals are displayed, but only the sine wave is triggered.
- k. Set the TRIGGER SOURCE switch to MODE.
- l. Set the DISPLAY MODE switch to CH 1.
- m. Check that the square wave only is displayed and triggered.
- n. Set the DISPLAY MODE switch to ADD.
- o. Set the CH 1 Coupling switch to OFF.
- p. Check that the sine wave only is displayed and triggered.
- q. Set the CH 1 Coupling switch to DC and CH 2 Coupling switch to OFF.
- r. Check that the square wave only is displayed and triggered.
- s. Set the DISPLAY MODE switch to CHOP.
- t. Check that the square wave and a straight line is displayed and the square wave is triggered.
- u. Set the CH 2 Coupling switch to DC and the CH 1 Coupling switch to Off.
- v. Check that the sine wave and a straight line are displayed and the sine wave is triggered.
- w. Set the DISPLAY MODE switch to CH 2.
- x. Check that the sine wave only is displayed and triggered.
- y. Set both Coupling switches to DC.
- z. Remove the connections from the CH 1 and CH 2 inputs.

9. ADJUST LOW FREQUENCY COMPENSATION

- a. Set the time-base for 0.2 milliseconds per division.
- b. Set both VOLTS/DIV switches to 10 mV.
- c. Connect a 1 kHz, Fast Rise signal from the Square Wave Generator, through a 5X attenuator to the CH 1 input.

- d. Set the DISPLAY MODE switch to CH 1 and the PG506 output for 5 divisions of crt deflection.
- e. Adjust the CH 1 LF (R1424) for minimum long-term tilt of the square wave flat-top.
- f. Repeat parts c, d, and e, substituting CH 2 control (R2424) and connector.

HIGH FREQUENCY PROCEDURE

Equipment Required:

- | | |
|--|---|
| <ul style="list-style-type: none"> 1. Test Oscilloscope 2. Sampling Unit (2 required) 3. Sampling Head (2 required) 4. Sampling Time Base 5. Signal Pickoff (Tektronix Calibration Fixture) 6. Signal Pickoff (Tektronix CT3) 7. Cable (50-Ohm) 8. Adapter (BNC male to GR) (3 required) | <ul style="list-style-type: none"> 9. Fast-Rise Pulse Generator 10. Medium Frequency Leveled, Sine Wave Generator 11. High Frequency Leveled, Sine Wave Generator 12. Plug-In Extender (flexible) 13. Dual-Input Coupler 14. 5X Attenuator (BNC) 15. VSWR Test Fixture |
|--|---|

BEFORE YOU BEGIN, see ADJUSTMENT LOCATIONS in the Diagrams section.

NOTE

Perform the following High Frequency Procedure to ensure high-frequency compatibility with 7000-series Mainframes.

10. ADJUST HIGH FREQUENCY COMPENSATION (ABERRATIONS +4%, -4%, 6% p-p MAXIMUM; RISE-TIME, 850 ps MAXIMUM)

- a. Sampling Setup:
 - 1) Install both 7S11 sampling units into 7704A vertical compartments and the 7T11 sampling time base into the A horizontal compartment.
 - 2) Connect the fast-rise pulse generator trigger output to the 7T11 trigger input through a BNC cable and BNC to SMA adapter.
 - 3) Set controls as follows:

7704A

- Vertical Mode.....Left
- Horizontal Mode.....A
- Power.....On
- Intensity.....As desired

- ReadoutAs desired
- FocusAs desired
- Graticule.....As desired

7T11

- Time Pos Range50 ns
- Time/Div Sweep Range1 ns
- Trig AmpX1
- Trig Ext.....50 ohm
- Trig Slope+
- Trig Level.....Midrange
- SamplingSequential

7A24

- CH 1/CH 2 POSITIONMidrange
- CH 1/CH 2 VOLTS/DIV10 mV
- CH 1/CH 2 COUPLINGDC
- CH 1/CH 2 VARIABLE IN (Cal)
- DISPLAY MODE.....CH 1
- TRIGGER SOURCEMODE

7S11's

Polarity+ Up
 Volts/Div50 mV
 Dc offset.....Midrange
 Variable.....In (Cal)
 Dot Response.....Normal

284

Mode.....Pulse Output
 Lead Time.....75 ns
 Power.....On

- 4) Adjust left 7S11 dc offset for no shift while switching through the Volts/Div ranges. Return Volts/Div to 50 mV. Repeat for right 7S11.
- 5) Connect the fast-rise pulse generator pulse output through a GR to BNC adapter, BNC cable dual input coupler, and BNC to GR adapter to both 7S11 sampling head inputs.
- 6) Adjust the 7T11 Trigger Level, Stability, and Time Position to obtain approximately 2.5 division of pulse as shown in Figure 5-2.
- 7) Set the 7704A Vertical Mode Switch to Add the right 7S11 Polarity to Invert.
- 8) Adjust both 7S11's delay to reduce or cancel the short pulse. Refer to Figure 5-3.
- 9) Disconnect and remove the BNC cable, dual input couplers, and BNC to GR adapters from the 284 and 7S11's.

b. 7A24 Procedure:

- 1) Install flexible extender into 7704A B Horizontal.
- 2) Connect signal pickoff (067-0655-00) to flexible extender and connect 7A24 to signal pickoff.
- 3) Connect signal pickoff wires A11 (+Vertical) to the left 7S11 input and B11 (-Vertical) to the right 7S11 input. Connect trigger pickoff wires A13 and B13 to their respective terminating resistors on the signal pickoff.
- 4) Connect the fast-rise pulse generator pulse output to the 7A24 CH 1 input through a 9 inch BNC cable and 5X attenuator.
- 5) Switch the 7704A Vertical Mode to Left and adjust the left 7S11 variable for 2.5 divisions. Switch the Vertical Mode to Add and adjust the right 7S11 variable for 5.0 divisions.
- 6) Adjust the 7A24 CH 1 POSITION control so that the top and bottom of the waveform coincides with the dotted horizontal lines on the 7704A crt.
- 7) Switch the 7704A Vertical Mode to Left and position the top of the waveform to graticule center with the left 7S11 (dc offset control). Switch the 7704A Vertical Mode to Add and position the top of the waveform to graticule center with the right 7S11 dc offset control.
- 8) Check that aberrations do not exceed +4% or -4% and 6% peak-to-peak. Risetime should not exceed 850 ps.

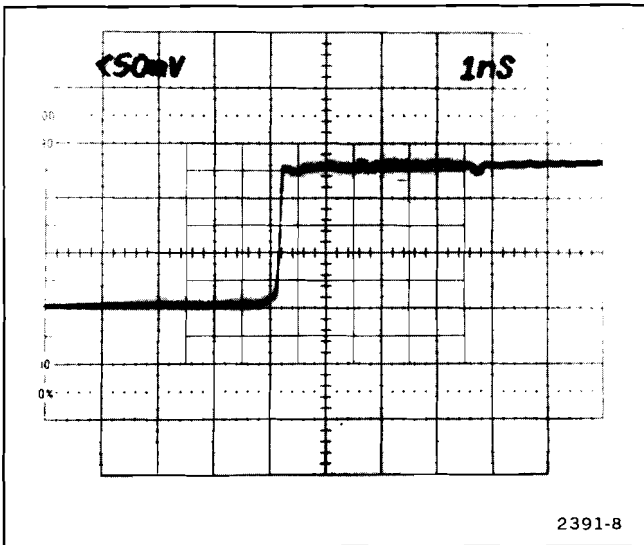

Figure 5-2. Approximately 2.5 division pulse obtained in step 11f.

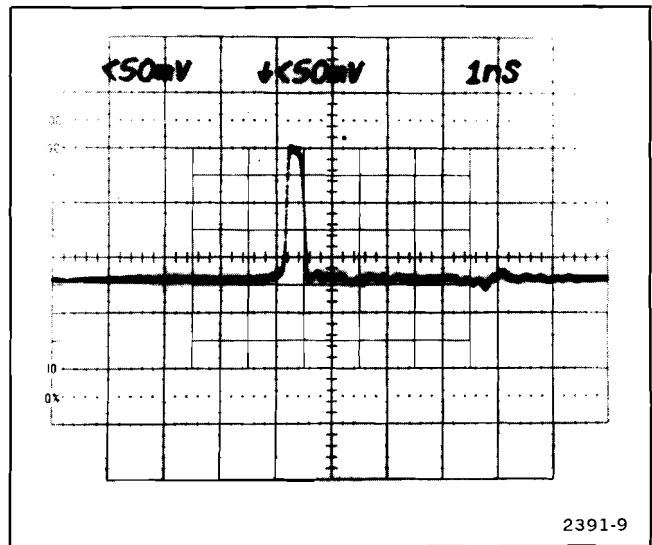

Figure 5-3. Short pulse before cancellation.

Performance Check and Adjustment—7A24 (SN B103000 & UP)

9) Preset—(1) C1753 for maximum front corner rolloff, (2) C1560 for maximum overshoot, (3) C1430 for maximum front corner rolloff, (4) R1515 for minimum aberrations.

10) Adjust—(1) R1515 and C1515 for best flat top from 5 to 15 ns after the front corner, (2) R1430 and C1430 for best flat top over the first 5 ns after the front corner.

11) Adjust R1560 and C1560 for minimum aberrations.

12) Adjust C1753 until aberrations start to increase.

13) Repeat parts j and k for minimum aberrations and best flat top (parts 10, 11, and 12), over first 20 ns after front corner.

14) Remove fast-rise pulse generator connection from 7A24 CH 1 and connect to CH 2 input. Change 7A24 DISPLAY MODE to CH 2.

15) Repeat parts 9 through 13 substituting CH 2 controls—C2753, C2560, C2430, R2515, C2515, R2430, and R2560.

11. ADJUST TRIGGER HIGH FREQUENCY COMPENSATION (ABERRATIONS, 10% MAX.)

- a. Exchange signal pickoff cables A11 with A13 and B11 with B13.
- b. Check that aberrations are 10% peak-to-peak or less.
- c. Adjust R2562, C2562, and C2853 for minimum aberrations and best flat top over first 10 ns after front corner.
- d. Set 7A24 DISPLAY MODE to CH 1 and fast-rise pulse generator output to CH 1.
- e. Check that aberrations are 10% peak-to-peak or less.
- f. Adjust R1562, C1562, and C1853 for minimum aberrations and best flat top over first 10 ns after front corner.
- g. Repeat steps 11 and 12 to reduce interaction. Disconnect BNC cables from 7A24 and 7T11 trigger input.
- h. Exchange signal pickoff cables A13 with A11 and B13 with B11 to obtain the display signal.
- i. Set CH 1 and CH 2 VOLTS/DIV to .5 V.

12. CHECK BANDWIDTH (-3 dB OR LESS AT 450 MHz)

- a. Connect the SG503 Medium Frequency Signal Generator through the precision 50 ohm cable and GR to BNC adapter to the CT3 Signal Pickoff input. Connect the CT3 through-signal output to the 7A24 CH 1 with a GR to BNC adapter. Connect the CT3 signal out through a BNC cable and BNC to SMA adapter to the 7T11 trigger input.
- b. Set SG503 output for 6 divisions of 50 kHz signal. Change frequency to 100 MHz.
- c. Check that display level is 5.8 divisions or more. Change frequency to 200 MHz.
- d. Check that display level is 5.6 divisions or more.
- e. Disconnect cable from SG503 to CT3 and connect to the SG504 high-frequency signal generator leveling head. Set SG504 output for 6 divisions of 50 kHz signal and change frequency to 300 MHz.
- f. Check that display level is 5.1 divisions or more. Change frequency to 350 MHz.
- g. Check that display level is 4.8 divisions or more. Change frequency to 400 MHz.
- h. Check that display frequency is 4.5 divisions or more. Change frequency to 450 MHz.
- i. Check that display frequency is 4.2 divisions or more.
- j. Remove the CT3 through signal output from CH 1 to CH 2 and repeat parts a through i.
- k. Disconnect the SG504 from the 7A24 and remove cable between CT3 and 7T11. Remove both 7S11's, the 7T11, and the flexible extender from the 7704A. Remove the 7A24 from the signal pickoff.
- l. Install the 7A24 into the left vertical of the 7704A and install the 7B80 into the B horizontal of the 7704A. Switch the 7704A to Left Vertical and B Horizontal.

13. CHECK COMMON MODE REJECTION RATIO (AT LEAST 10:1)

- a. Connect the SG503 medium frequency signal generator output to the 7A24 CH 1 and CH 2 inputs through a dual input coupler. Set the 7A24 CH 1 VOLTS/DIV to 20 mV CH 2 VOLTS/DIV to 10 mV, and the DISPLAY MODE to CH 1.

✓Performance Requirement check; see introductory information.

Performance Check and Adjustment—7A24 (SN B103000 & UP)

s. Position the trace to the top graticule line with the 7A22 Position control and reconnect the SG 504 Leveling Head to the VSWR test fixture RF In connector. Vary the SG 504 frequency from 350 MHz to 400 MHz.

t. CHECK—Trace does not drop below 8 divisions (1.4 to 1 or less). Change the 7A24 CH 2 VOLTS/DIV to 10 mV and repeat steps p. to s.

u. Remove VSWR test fixture from CH 2 to CH 1 and repeat steps p. to s.

v. Change 7A22 VOLTS/DIV to 50 μ V and disconnect the SG 504 Leveling Head from the VSWR test fixture RF In connector.

w. Position the trace to the top graticule line with the 7A22 Position control. Reconnect the SG 504 to the VSWR test fixture RF in.

x. Change the 7A24 CH 1 VOLTS/DIV to 20 mV and vary the SG 504 frequency from 250 MHz to 400 MHz.

y. CHECK—Trace does not drop below 5.8 divisions (1.15 to 1 or less). Repeat for each VOLTS/DIV range from 50 mV to 1 volt.

z. Change 7A24 DISPLAY MODE to CH 1 and move VWSR test fixture cable from CH 1 to CH 2 input. Repeat above check for each CH 2 VOLTS/DIV range from 20 mV to 1 volt.

INSTRUMENT OPTIONS

No options were available for this instrument at the time of this printing.

Information on any subsequent options may be found in the CHANGE INFORMATION section in the back of this manual.

REPLACEABLE ELECTRICAL PARTS

PARTS ORDERING INFORMATION

Replacement parts are available from or through your local Tektronix, Inc. Field Office or representative.

Changes to Tektronix instruments are sometimes made to accommodate improved components as they become available, and to give you the benefit of the latest circuit improvements developed in our engineering department. It is therefore important, when ordering parts, to include the following information in your order: Part number, instrument type or number, serial number, and modification number if applicable.

If a part you have ordered has been replaced with a new or improved part, your local Tektronix, Inc. Field Office or representative will contact you concerning any change in part number.

Change information, if any, is located at the rear of this manual.

SPECIAL NOTES AND SYMBOLS

X000 Part first added at this serial number
00X Part removed after this serial number

ITEM NAME

In the Parts List, an Item Name is separated from the description by a colon (:). Because of space limitations, an Item Name may sometimes appear as incomplete. For further Item Name identification, the U.S. Federal Cataloging Handbook H6-1 can be utilized where possible.

ABBREVIATIONS

ACTR	ACTUATOR	PLSTC	PLASTIC
ASSY	ASSEMBLY	QTZ	QUARTZ
CAP	CAPACITOR	RECP	RECEPTACLE
CER	CERAMIC	RES	RESISTOR
CKT	CIRCUIT	RF	RADIO FREQUENCY
COMP	COMPOSITION	SEL	SELECTED
CONN	CONNECTOR	SEMICOND	SEMICONDUCTOR
ELCTLT	ELECTROLYTIC	SENS	SENSITIVE
ELEC	ELECTRICAL	VAR	VARIABLE
INCAND	INCANDESCENT	WW	WIREWOUND
LED	LIGHT EMITTING DIODE	XFMR	TRANSFORMER
NONWIR	NON WIREWOUND	XTAL	CRYSTAL

CROSS INDEX—MFR. CODE NUMBER TO MANUFACTURER

Mfr. Code	Manufacturer	Address	City, State, Zip
01121	ALLEN-BRADLEY COMPANY	1201 2ND STREET SOUTH	MILWAUKEE, WI 53204
01295	TEXAS INSTRUMENTS, INC., SEMICONDUCTOR GROUP	P O BOX 5012, 13500 N CENTRAL EXPRESSWAY	DALLAS, TX 75222
03508	GENERAL ELECTRIC COMPANY, SEMI-CONDUCTOR PRODUCTS DEPARTMENT	ELECTRONICS PARK	SYRACUSE, NY 13201
03888	KDI PYROFILM CORPORATION	60 S JEFFERSON ROAD	WHIPPANY, NJ 07981
04713	MOTOROLA, INC., SEMICONDUCTOR PROD. DIV.	5005 E MCDOWELL RD, PO BOX 20923	PHOENIX, AZ 85036
07263	FAIRCHILD SEMICONDUCTOR, A DIV. OF FAIRCHILD CAMERA AND INSTRUMENT CORP.	464 ELLIS STREET	MOUNTAIN VIEW, CA 94042
12697	CLAROSTAT MFG. CO., INC.	LOWER WASHINGTON STREET	DOVER, NH 03820
32997	BOURNS, INC., TRIMPOT PRODUCTS DIV.	1200 COLUMBIA AVE.	RIVERSIDE, CA 92507
50157	MIDWEST COMPONENTS INC.	P. O. BOX 787 1981 PORT CITY BLVD.	MUSKEGON, MI 49443
56289	SPRAGUE ELECTRIC CO.		NORTH ADAMS, MA 01247
72982	ERIE TECHNOLOGICAL PRODUCTS, INC.	644 W. 12TH ST.	ERIE, PA 16512
73899	JFD ELECTRONICS COMPONENTS CORP.	PINETREE ROAD	OXFORD, NC 27565
75042	TRW ELECTRONIC COMPONENTS, IRC FIXED RESISTORS, PHILADELPHIA DIVISION	401 N. BROAD ST.	PHILADELPHIA, PA 19108
76493	BELL INDUSTRIES, INC., MILLER, J. W., DIV.	19070 REYES AVE., P O BOX 5825	COMPTON, CA 90224
78488	STACKPOLE CARBON CO.		ST. MARYS, PA 15857
80009	TEKTRONIX, INC.	P O BOX 500	BEAVERTON, OR 97077
82389	SWITCHCRAFT, INC.	5555 N. ELSTON AVE.	CHICAGO, IL 60630
91637	DALE ELECTRONICS, INC.	P. O. BOX 609	COLUMBUS, NE 68601
95275	VITRAMON, INC.	P O BOX 544	BRIDGEPORT, CT 06601

Replaceable Electrical Parts—7A24 (SN B103000 & UP)

Ckt No.	Tektronix Part No.	Serial/Model No. Eff	Dscont	Name & Description	Mfr Code	Mfr Part Number
A1	670-2464-01			CKT BOARD ASSY:ATTENUATOR,CH1	80009	670-2464-01
A2	670-2310-04	B103000	B109999	CKT BOARD ASSY:READOUT,CH1	80009	670-2310-04
A2	670-2310-06	B110000	B114399	CKT BOARD ASSY:READOUT,CH1	80009	670-2310-06
A2	670-2410-08	B114400		CKT BOARD ASSY:READOUT,CH1	80009	670-2410-08
A3	670-2464-01			CKT BOARD ASSY:ATTENUATOR,CH2	80009	670-2464-01
A4	670-2310-04			CKT BOARD ASSY:READOUT,CH2	80009	670-2310-04
A5	670-2710-04	B103000	B113599	CKT BOARD ASSY:AMPLIFIER	80009	670-2710-04
A5	670-2710-05	B113600		CKT BOARD ASSY:AMPLIFIER	80009	670-2710-05
A6	670-5389-00			CKT BOARD ASSY:BOAT ROCKER	80009	670-5389-00
C49	283-0003-00	XB110000		CAP.,FXD,CER DI:0.01UF,+80-20%,150V	72982	855-558Z5U-103Z
C621	283-0000-00	B103000	B109999	CAP.,FXD,CER DI:0.001UF,+100-0%,500V	72982	831-516E102P
C621	283-0177-00	B110000		CAP.,FXD,CER DI:1UF,+80-20%,25V	56289	273C5
C630	283-0000-00	B103000	B109999X	CAP.,FXD,CER DI:0.001UF,+100-0%,500V	72982	831-516E102P
C631	283-0000-00	B103000	B109999X	CAP.,FXD,CER DI:0.001UF,+100-0%,500V	72982	831-516E102P
C634	283-0000-00	B103000	B109999X	CAP.,FXD,CER DI:0.001UF,+100-0%,500V	72982	831-516E102P
C635	283-0000-00	B103000	B109999X	CAP.,FXD,CER DI:0.001UF,+100-0%,500V	72982	831-516E102P
C638	283-0000-00	B103000	B109999X	CAP.,FXD,CER DI:0.001UF,+100-0%,500V	72982	831-516E102P
C643	283-0000-00	B103000	B109999X	CAP.,FXD,CER DI:0.001UF,+100-0%,500V	72982	831-516E102P
C647	283-0000-00	B103000	B109999X	CAP.,FXD,CER DI:0.001UF,+100-0%,500V	72982	831-516E102P
C648	283-0003-00	B103000	B109999X	CAP.,FXD,CER DI:0.01UF,+80-20%,150V	72982	855-558Z5U-103Z
C649	283-0000-00	B103000	B109999X	CAP.,FXD,CER DI:0.001UF,+100-0%,500V	72982	831-516E102P
C1012	283-0003-00			CAP.,FXD,CER DI:0.01UF,+80-20%,150V	72982	855-558Z5U-103Z
C1014	283-0003-00			CAP.,FXD,CER DI:0.01UF,+80-20%,150V	72982	855-558Z5U-103Z
C1015	283-0003-00			CAP.,FXD,CER DI:0.01UF,+80-20%,150V	72982	855-558Z5U-103Z
C1018	283-0003-00			CAP.,FXD,CER DI:0.01UF,+80-20%,150V	72982	855-558Z5U-103Z
C1022	283-0003-00			CAP.,FXD,CER DI:0.01UF,+80-20%,150V	72982	855-558Z5U-103Z
C1024	283-0003-00			CAP.,FXD,CER DI:0.01UF,+80-20%,150V	72982	855-558Z5U-103Z
C1025	283-0003-00			CAP.,FXD,CER DI:0.01UF,+80-20%,150V	72982	855-558Z5U-103Z
C1028	283-0003-00			CAP.,FXD,CER DI:0.01UF,+80-20%,150V	72982	855-558Z5U-103Z
C1316	283-0100-00	B103000	B113494	CAP.,FXD,CER DI:0.0047UF,10%,200V (NOMINAL VALUE,SELECTED)	56289	273C3
C1316	283-0028-00	B113495		CAP.,FXD,CER DI:0.0022UF,20%,50V (NOMINAL VALUE,SELECTED)	56289	19C606
C1318	281-0543-00	B103000	B113494	CAP.,FXD,CER DI:270PF,10%,500V (NOMINAL VALUE,SELECTED)	72982	301055X5P271K
C1318	281-0638-00	B113495		CAP.,FXD,CER DI:240PF,5%,500V (NOMINAL VALUE,SELECTED)	72982	301000Z5D241J
C1319	283-0321-00			CAP.,FXD,CER DI:1.8PF,0.25PF,50V (NOMINAL VALUE,SELECTED)	95275	VJ0805A1R8C-H
C1328	283-0000-00			CAP.,FXD,CER DI:0.001UF,+100-0%,500V	72982	831-516E102P
C1424	283-0370-00	B103000	B113494	CAP.,FXD,CER DI:0.027UF,5%,100V (NOMINAL VALUE,SELECTED)	72982	8131N153X7R0273J
C1424	283-0239-00	B113495		CAP.,FXD,CER DI:0.022UF,10%,50V (NOMINAL VALUE,SELECTED)	72982	8121N083X7R0223K
C1426	281-0540-00			CAP.,FXD,CER DI:51PF,5%,500V (NOMINAL VALUE,SELECTED)	72982	301-000U2J0510J
C1430	281-0122-00			CAP.,VAR,CER DI:2.5-9PF,100V	72982	518-000A2.5-9
C1450	283-0353-00			CAP.,FXD,CER DI:0.1UF,10%,50V	95275	VJ1210Y104K-H
C1460	283-0353-00			CAP.,FXD,CER DI:0.1UF,10%,50V	95275	VJ1210Y104K-H
C1473	281-0528-00	XB113495		CAP.,FXD,CER DI:82PF,+/-8.2PF,500V	72982	301-000U2M0820K
C1515	281-0158-00			CAP.,VAR,CER DI:7-45PF,50V	73899	DVJ-5006
C1530	281-0218-00			CAP.,VAR,CER DI:1-5PF,+2-2.5%,100V (ADDED WHEN NEEDED)	72982	513-001 1-5
C1555	283-0000-00			CAP.,FXD,CER DI:0.001UF,+100-0%,500V	72982	831-516E102P
C1560	281-0151-00			CAP.,VAR,CER DI:1-3PF,100V	72982	518-600A1-3
C1562	281-0151-00			CAP.,VAR,CER DI:1-3PF,100V	72982	518-600A1-3
C1753	281-0151-00			CAP.,VAR,CER DI:1-3PF,100V	72982	518-600A1-3

Replaceable Electrical Parts—7A24 (SN B103000 & UP)

Ckt No.	Tektronix Part No.	Serial/Model No. Eff	Dscont	Name & Description	Mfr Code	Mfr Part Number
C1853	281-0151-00			CAP., VAR, CER DI:1-3PF, 100V	72982	518-600A1-3
C1857	283-0140-00			CAP., FXD, CER DI:4.7PF, 5%, 50V	72982	8101E003A479C
C1990	283-0000-00			CAP., FXD, CER DI:0.001UF, +100-0%, 500V	72982	831-516E102P
C1991	283-0000-00			CAP., FXD, CER DI:0.001UF, +100-0%, 500V	72982	831-516E102P
C2316	283-0100-00	B103000	B113494	CAP., FXD, CER DI:0.0047UF, 10%, 200V (NOMINAL VALUE, SELECTED)	56289	273C3
C2316	283-0028-00	B113495		CAP., FXD, CER DI:0.0022UF, 20%, 50V (NOMINAL VALUE, SELECTED)	56289	19C606
C2318	281-0543-00	B103000	B113494	CAP., FXD, CER DI:270PF, 10%, 500V (NOMINAL VALUE, SELECTED)	72982	301055X5P271K
C2318	281-0638-00	B113495		CAP., FXD, CER DI:240PF, 5%, 500V (NOMINAL VALUE, SELECTED)	72982	301000Z5D241J
C2319	283-0321-00			CAP., FXD, CER DI:1.8PF, 0.25PF, 50V (NOMINAL VALUE, SELECTED)	95275	VJ0805A1R8C-H
C2328	283-0000-00			CAP., FXD, CER DI:0.001UF, +100-0%, 500V	72982	831-516E102P
C2424	283-0370-00	B103000	B113494	CAP., FXD, CER DI:0.027UF, 5%, 100V (NOMINAL VALUE, SELECTED)	72982	8131N153X7R0273J
C2424	283-0239-00	B113495		CAP., FXD, CER DI:0.022UF, 10%, 50V (NOMINAL VALUE, SELECTED)	72982	8121N083X7R0223K
C2426	281-0540-00			CAP., FXD, CER DI:51PF, 5%, 500V (NOMINAL VALUE, SELECTED)	72982	301-000U2J0510J
C2430	281-0122-00			CAP., VAR, CER DI:2.5-9PF, 100V	72982	518-000A2.5-9
C2450	283-0353-00			CAP., FXD, CER DI:0.1UF, 10%, 50V	95275	VJ1210Y104K-H
C2460	283-0353-00			CAP., FXD, CER DI:0.1UF, 10%, 50V	95275	VJ1210Y104K-H
C2515	281-0158-00			CAP., VAR, CER DI:7-45PF, 50V	73899	DVJ-5006
C2555	283-0000-00			CAP., FXD, CER DI:0.001UF, +100-0%, 500V	72982	831-516E102P
C2560	281-0151-00			CAP., VAR, CER DI:1-3PF, 100V	72982	518-600A1-3
C2562	281-0151-00			CAP., VAR, CER DI:1-3PF, 100V	72982	518-600A1-3
C2753	281-0151-00			CAP., VAR, CER DI:1-3PF, 100V	72982	518-600A1-3
C2853	281-0151-00			CAP., VAR, CER DI:1-3PF, 100V	72982	518-600A1-3
C2857	283-0140-00			CAP., FXD, CER DI:4.7PF, 5%, 50V	72982	8101E003A479C
CR621	152-0141-02			SEMICONV DEVICE:SILICON, 30V, 150MA	01295	1N4152R
CR630	152-0141-02	XB110000		SEMICONV DEVICE:SILICON, 30V, 150MA	01295	1N4152R
CR631	152-0141-02	XB110000		SEMICONV DEVICE:SILICON, 30V, 150MA	01295	1N4152R
CR634	152-0141-02	XB110000		SEMICONV DEVICE:SILICON, 30V, 150MA	01295	1N4152R
CR635	152-0141-02	XB110000		SEMICONV DEVICE:SILICON, 30V, 150MA	01295	1N4152R
CR638	152-0141-02	XB110000		SEMICONV DEVICE:SILICON, 30V, 150MA	01295	1N4152R
CR647	152-0141-02			SEMICONV DEVICE:SILICON, 30V, 150MA	01295	1N4152R
CR648	152-0141-02	XB110000		SEMICONV DEVICE:SILICON, 30V, 150MA	01295	1N4152R
CR1301	152-0333-00			SEMICONV DEVICE:SILICON, 55V, 200MA	07263	FDH-6012
CR1302	152-0333-00			SEMICONV DEVICE:SILICON, 55V, 200MA	07263	FDH-6012
CR1325	152-0141-02			SEMICONV DEVICE:SILICON, 30V, 150MA	01295	1N4152R
CR1450	152-0141-02			SEMICONV DEVICE:SILICON, 30V, 150MA	01295	1N4152R
CR1488	152-0141-02			SEMICONV DEVICE:SILICON, 30V, 150MA	01295	1N4152R
CR1970	152-0141-02			SEMICONV DEVICE:SILICON, 30V, 150MA	01295	1N4152R
CR2301	152-0333-00			SEMICONV DEVICE:SILICON, 55V, 200MA	07263	FDH-6012
CR2302	152-0333-00			SEMICONV DEVICE:SILICON, 55V, 200MA	07263	FDH-6012
CR2325	152-0141-02			SEMICONV DEVICE:SILICON, 30V, 150MA	01295	1N4152R
CR2450	152-0141-02			SEMICONV DEVICE:SILICON, 30V, 150MA	01295	1N4152R
CR2474	152-0141-02			SEMICONV DEVICE:SILICON, 30V, 150MA	01295	1N4152R
CR2484	152-0141-02			SEMICONV DEVICE:SILICON, 30V, 150MA	01295	1N4152R
CR2488	152-0141-02			SEMICONV DEVICE:SILICON, 30V, 150MA	01295	1N4152R
CR2970	152-0141-02			SEMICONV DEVICE:SILICON, 30V, 150MA	01295	1N4152R
F100	159-0118-00			FUSE, THERMAL: 50 OHM	80009	159-0118-00
L1301	276-0507-00			SHIELDING BEAD, :FERRITE	78488	57-3443
L1450	108-0245-00			COIL, RF: 3.9UH	76493	B6310-1

Replaceable Electrical Parts—7A24 (SN B103000 & UP)

Ckt No.	Tektronix Part No.	Serial/Model No. Eff	Dscnt	Name & Description	Mfr Code	Mfr Part Number
L1460	108-0245-00			COIL, RF: 3.9UH	76493	B6310-1
L2301	276-0507-00			SHIELDING BEAD, : FERRITE	78488	57-3443
L2450	108-0245-00			COIL, RF: 3.9UH	76493	B6310-1
L2460	108-0245-00			COIL, RF: 3.9UH	76493	B6310-1
LR1010	108-0184-00			COIL, RF: 3.2UH(WOUND ON A 10 OHM RESISTOR)	80009	108-0184-00
LR1014	108-0184-00			COIL, RF: 3.2UH(WOUND ON A 10 OHM RESISTOR)	80009	108-0184-00
LR1020	108-0184-00			COIL, RF: 3.2UH(WOUND ON A 10 OHM RESISTOR)	80009	108-0184-00
LR1024	108-0184-00			COIL, RF: 3.2UH(WOUND ON A 10 OHM RESISTOR)	80009	108-0184-00
Q620	151-0254-00	B103000	B109999	TRANSISTOR: SILICON, NPN	80009	151-0254-00
Q620	151-0281-00	B110000		TRANSISTOR: SILICON, NPN	03508	X16P4039
Q1450	151-0342-00			TRANSISTOR: SILICON, PNP	07263	S035928
Q1460	151-0342-00			TRANSISTOR: SILICON, PNP	07263	S035928
Q1470	151-0342-00			TRANSISTOR: SILICON, PNP	07263	S035928
Q1480	151-0342-00			TRANSISTOR: SILICON, PNP	07263	S035928
Q1910	151-0188-00			TRANSISTOR: SILICON, PNP	04713	SPS6868K
Q1920	151-0188-00			TRANSISTOR: SILICON, PNP	04713	SPS6868K
Q1930	151-0188-00			TRANSISTOR: SILICON, PNP	04713	SPS6868K
Q1940	151-0188-00			TRANSISTOR: SILICON, PNP	04713	SPS6868K
Q1950	151-0188-00			TRANSISTOR: SILICON, PNP	04713	SPS6868K
Q1960	151-0302-00			TRANSISTOR: SILICON, NPN	07263	S038487
Q2450	151-0342-00			TRANSISTOR: SILICON, PNP	07263	S035928
Q2460	151-0342-00			TRANSISTOR: SILICON, PNP	07263	S035928
Q2470	151-0342-00			TRANSISTOR: SILICON, PNP	07263	S035928
Q2480	151-0342-00			TRANSISTOR: SILICON, PNP	07263	S035928
Q2910	151-0188-00			TRANSISTOR: SILICON, PNP	04713	SPS6868K
Q2920	151-0188-00			TRANSISTOR: SILICON, PNP	04713	SPS6868K
Q2930	151-0188-00			TRANSISTOR: SILICON, PNP	04713	SPS6868K
Q2940	151-0188-00			TRANSISTOR: SILICON, PNP	04713	SPS6868K
Q2950	151-0188-00			TRANSISTOR: SILICON, PNP	04713	SPS6868K
Q2960	151-0302-00			TRANSISTOR: SILICON, NPN	07263	S038487
R100	317-0392-00			RES., FXD, CMPSN: 3.9K OHM, 5%, 0.125W	01121	BB3925
R101	305-0510-00			RES., FXD, CMPSN: 51 OHM, 5%, 2W	01121	HB5105
R106	307-1020-00			ATTENUATOR, FXD: 50 OHM, 2X	80009	307-1020-00
R110	307-1023-00			ATTENUATOR, FXD: 50 OHM, 5X	80009	307-1023-00
R119	307-1024-00			ATTENUATOR, FXD: 50 OHM, 10X	80009	307-1024-00
R620	315-0471-00	XB110000		RES., FXD, CMPSN: 470 OHM, 5%, 0.25W	01121	CB4715
R621	321-0223-00	B103000	B109999	RES., FXD, FILM: 2.05K OHM, 1%, 0.125W	91637	MFF1816G20500F
R621	321-0222-00	B110000		RES., FXD, FILM: 2K OHM, 1%, 0.125W	91637	MFF1816G20000F
R622	321-0299-00			RES., FXD, FILM: 12.7K OHM, 1%, 0.125W	91637	MFF1816G12701F
R629	315-0101-00	XB110000		RES., FXD, CMPSN: 100 OHM, 5%, 0.25W	01121	CB1015
R630	315-0154-00			RES., FXD, CMPSN: 150K OHM, 5%, 0.25W	01121	CB1545
R631	315-0753-00			RES., FXD, CMPSN: 75K OHM, 5%, 0.25W	01121	CB7535
R633	315-0753-00			RES., FXD, CMPSN: 75K OHM, 5%, 0.25W	01121	CB7535
R634	315-0154-00			RES., FXD, CMPSN: 150K OHM, 5%, 0.25W	01121	CB1545
R635	321-0344-00			RES., FXD, FILM: 37.4K OHM, 1%, 0.125W	91637	MFF1816G37401F
R636	315-0154-00			RES., FXD, CMPSN: 150K OHM, 5%, 0.25W	01121	CB1545
R637	315-0471-00	B103000	B109999X	RES., FXD, CMPSN: 470 OHM, 5%, 0.25W	01121	CB4715
R639	315-0753-00			RES., FXD, CMPSN: 75K OHM, 5%, 0.25W	01121	CB7535
R640	315-0753-00			RES., FXD, CMPSN: 75K OHM, 5%, 0.25W	01121	CB7535
R642	315-0513-00			RES., FXD, CMPSN: 51K OHM, 5%, 0.25W	01121	CB5135
R643	321-0344-00			RES., FXD, FILM: 37.4K OHM, 1%, 0.125W	91637	MFF1816G37401F
R645	315-0154-00			RES., FXD, CMPSN: 150K OHM, 5%, 0.25W	01121	CB1545
R646	315-0154-00			RES., FXD, CMPSN: 150K OHM, 5%, 0.25W	01121	CB1545
R647	315-0133-00			RES., FXD, CMPSN: 13K OHM, 5%, 0.25W	01121	CB1335
R648	315-0154-00			RES., FXD, CMPSN: 150K OHM, 5%, 0.25W	01121	CB1545
R810	315-0111-00			RES., FXD, CMPSN: 110 OHM, 5%, 0.25W	01121	CB1115

Replaceable Electrical Parts—7A24 (SN B103000 & UP)

Ckt No.	Tektronix Part No.	Serial/Model No. Eff	Dscont	Name & Description	Mfr Code	Mfr Part Number
R811	315-0111-00			RES., FXD, CMPSN: 110 OHM, 5%, 0.25W	01121	CB1115
R1010	315-0101-00			RES., FXD, CMPSN: 100 OHM, 5%, 0.25W	01121	CB1015
R1301	311-1268-00			RES., VAR, NONWIR: 10K OHM, 10%, 0.50W	32997	3329P-L58-103
R1303	315-0123-00			RES., FXD, CMPSN: 12K OHM, 5%, 0.25W	01121	CB1235
R1305	311-1263-00			RES., VAR, NONWIR: 1K OHM, 10%, 0.50W	32997	3329P-L58-102
R1307	315-0101-00			RES., FXD, CMPSN: 100 OHM, 5%, 0.25W	01121	CB1015
R1309	307-0132-00			RES., FXD, FILM: 54 OHM, 0.5%, 0.50W	03888	125R500T54R00D
R1310	311-1259-00			RES., VAR, NONWIR: 100 OHM, 10%, 0.50W	32997	3329P-L58-101
R1313	323-0175-00			RES., FXD, FILM: 649 OHM, 1%, 0.50W	75042	CECT0-6490F
R1315	323-0175-00			RES., FXD, FILM: 649 OHM, 1%, 0.50W	75042	CECT0-6490F
R1316	315-0112-00	B103000	B113494	RES., FXD, CMPSN: 1.1K OHM, 5%, 0.25W (NOMINAL VALUE, SELECTED)	01121	CB1125
R1316	315-0152-00	B113495		RES., FXD, CMPSN: 1.5K OHM, 5%, 0.25W (NOMINAL VALUE, SELECTED)	01121	CB1525
R1317	315-0510-00			RES., FXD, CMPSN: 51 OHM, 5%, 0.25W	01121	CB5105
R1318	315-0431-00	B103000	B113494	RES., FXD, CMPSN: 430 OHM, 5%, 0.25W (NOMINAL VALUE, SELECTED)	01121	CB4315
R1318	315-0511-00	B113495		RES., FXD, CMPSN: 510 OHM, 5%, 0.25W (NOMINAL VALUE, SELECTED)	01121	CB5115
R1319	315-0510-00			RES., FXD, CMPSN: 51 OHM, 5%, 0.25W	01121	CB5105
R1320	321-0776-03			RES., FXD, FILM: 3.501K OHM, 0.25%, 0.125W	91637	MFF1816D35010C
R1322	321-0776-03			RES., FXD, FILM: 3.501K OHM, 0.25%, 0.125W	91637	MFF1816D35010C
R1323	321-0776-03			RES., FXD, FILM: 3.501K OHM, 0.25%, 0.125W	91637	MFF1816D35010C
R1325	315-0562-00			RES., FXD, CMPSN: 5.6K OHM, 5%, 0.25W	01121	CB5625
R1326	323-0140-00			RES., FXD, FILM: 280 OHM, 1%, 0.50W	75042	CECT0-2800F
R1327	321-0132-00			RES., FXD, FILM: 232 OHM, 1%, 0.125W	91637	MFF1816G232R0F
R1328	315-0473-00			RES., FXD, CMPSN: 47K OHM, 5%, 0.25W	01121	CB4735
R1329	315-0473-00			RES., FXD, CMPSN: 47K OHM, 5%, 0.25W	01121	CB4735
R1332	311-1266-00			RES., VAR, NONWIR: 2.5K OHM, 10%, 0.50W	32997	3329P-L58-252
R1334	315-0510-00			RES., FXD, CMPSN: 51 OHM, 5%, 0.25W	01121	CB5105
R1336	315-0510-00			RES., FXD, CMPSN: 51 OHM, 5%, 0.25W	01121	CB5105
R1401	321-0068-00			RES., FXD, FILM: 49.9 OHM, 1%, 0.125W	91637	MFF1816G49R90F
R1403	321-0068-00			RES., FXD, FILM: 49.9 OHM, 1%, 0.125W	91637	MFF1816G49R90F
R1410	311-1259-00			RES., VAR, NONWIR: 100 OHM, 10%, 0.50W	32997	3329P-L58-101
R1413	323-0186-00			RES., FXD, FILM: 845 OHM, 1%, 0.50W	75042	CECT0-8450F
R1415	323-0186-00			RES., FXD, FILM: 845 OHM, 1%, 0.50W	75042	CECT0-8450F
R1421	315-0202-00			RES., FXD, CMPSN: 2K OHM, 5%, 0.25W	01121	CB2025
R1422	315-0122-00			RES., FXD, CMPSN: 1.2K OHM, 5%, 0.25W	01121	CB1225
R1423A	311-1854-00			RES., VAR, NONWIR: 1K OHM, 10%, 0.50W	01121	14M403
R1423B	311-1853-00			RES., VAR, NONWIR: 2.5K OHM, 10%, 0.50W	01121	18M838
R1424	311-1269-00			RES., VAR, NONWIR: 20K OHM, 10%, 0.50W	32997	3329P-L58-203
R1426	315-0911-00			RES., FXD, CMPSN: 910 OHM, 5%, 0.25W (NOMINAL VALUE, SELECTED)	01121	CB9115
R1427	315-0510-00			RES., FXD, CMPSN: 51 OHM, 5%, 0.25W	01121	CB5105
R1429	315-0510-00			RES., FXD, CMPSN: 51 OHM, 5%, 0.25W	01121	CB5105
R1430	311-1260-00			RES., VAR, NONWIR: 250 OHM, 10%, 0.50W	32997	3329P-L58-251
R1431	315-0201-00			RES., FXD, CMPSN: 200 OHM, 5%, 0.25W	01121	CB2015
R1443	315-0362-00			RES., FXD, CMPSN: 3.6K OHM, 5%, 0.25W	01121	CB3625
R1446	315-0361-00			RES., FXD, CMPSN: 360 OHM, 5%, 0.25W	01121	CB3615
R1450	315-0470-00			RES., FXD, CMPSN: 47 OHM, 5%, 0.25W	01121	CB4705
R1452	323-0129-00			RES., FXD, FILM: 215 OHM, 1%, 0.50W	91637	MFF1226G215R0F
R1455	315-0391-00			RES., FXD, CMPSN: 390 OHM, 5%, 0.25W	01121	CB3915
R1460	315-0470-00			RES., FXD, CMPSN: 47 OHM, 5%, 0.25W	01121	CB4705
R1462	323-0129-00			RES., FXD, FILM: 215 OHM, 1%, 0.50W	91637	MFF1226G215R0F
R1465	315-0391-00			RES., FXD, CMPSN: 390 OHM, 5%, 0.25W	01121	CB3915
R1467	321-0204-00			RES., FXD, FILM: 1.3K OHM, 1%, 0.125W	91637	MFF1816G13000F
R1468	321-0211-00			RES., FXD, FILM: 1.54K OHM, 1%, 0.125W	91637	MFF1816G15400F

Replaceable Electrical Parts—7A24 (SN B103000 & UP)

Ckt No.	Tektronix Part No.	Serial/Model No. Eff	Dscont	Name & Description	Mfr Code	Mfr Part Number
R1470	315-0222-00			RES., FXD, CMPSN: 2.2K OHM, 5%, 0.25W	01121	CB2225
R1473	315-0362-00			RES., FXD, CMPSN: 3.6K OHM, 5%, 0.25W	01121	CB3625
R1480	315-0202-00			RES., FXD, CMPSN: 2K OHM, 5%, 0.25W	01121	CB2025
R1483	315-0362-00			RES., FXD, CMPSN: 3.6K OHM, 5%, 0.25W	01121	CB3625
R1486	315-0471-00			RES., FXD, CMPSN: 470 OHM, 5%, 0.25W	01121	CB4715
R1487	311-1320-00	B010100	B115549	RES., VAR, NONWIR: 5K OHM, 1W, W/SW (FURNISHED AS A UNIT WITH S1465)	12697	381CM-39700
R1487	311-1320-01	B115550		RES., VAR, NONWIR: 5K OHM, 10%, 1W, SPST SW (FURNISHED AS A UNIT WITH S1465)	12697	CM43494
R1488	315-0223-00			RES., FXD, CMPSN: 22K OHM, 5%, 0.25W	01121	CB2235
R1489	315-0273-00			RES., FXD, CMPSN: 27K OHM, 5%, 0.25W	01121	CB2735
R1501	323-0135-00			RES., FXD, FILM: 249 OHM, 1%, 0.50W	91637	MFF1226G249R0F
R1503	321-0068-00			RES., FXD, FILM: 49.9 OHM, 1%, 0.125W	91637	MFF1816G49R90F
R1504	321-0068-00			RES., FXD, FILM: 49.9 OHM, 1%, 0.125W	91637	MFF1816G49R90F
R1510	323-0128-00			RES., FXD, FILM: 210 OHM, 1%, 0.50W	75042	CECTO-2100F
R1512	323-0128-00			RES., FXD, FILM: 210 OHM, 1%, 0.50W	75042	CECTO-2100F
R1515	311-1261-00			RES., VAR, NONWIR: 500 OHM, 10%, 0.50W	32997	3329P-L58-501
R1550	315-0751-00			RES., FXD, CMPSN: 750 OHM, 5%, 0.25W	01121	CB7515
R1551	315-0132-00			RES., FXD, CMPSN: 1.3K OHM, 5%, 0.25W	01121	CB1325
R1555	315-0473-00			RES., FXD, CMPSN: 47K OHM, 5%, 0.25W	01121	CB4735
R1560	311-1260-00			RES., VAR, NONWIR: 250 OHM, 10%, 0.50W	32997	3329P-L58-251
R1562	311-1260-00			RES., VAR, NONWIR: 250 OHM, 10%, 0.50W	32997	3329P-L58-251
R1750	321-0068-00			RES., FXD, FILM: 49.9 OHM, 1%, 0.125W	91637	MFF1816G49R90F
R1752	323-0164-00			RES., FXD, FILM: 499 OHM, 1%, 0.50W	75042	CECTO-4990F
R1754	323-0164-00			RES., FXD, FILM: 499 OHM, 1%, 0.50W	75042	CECTO-4990F
R1762	321-0068-00			RES., FXD, FILM: 49.9 OHM, 1%, 0.125W	91637	MFF1816G49R90F
R1764	321-0068-00			RES., FXD, FILM: 49.9 OHM, 1%, 0.125W	91637	MFF1816G49R90F
R1767	322-0104-00			RES., FXD, FILM: 118 OHM, 1%, 0.25W	91637	MFF1421G118R0F
R1850	321-0068-00			RES., FXD, FILM: 49.9 OHM, 1%, 0.125W	91637	MFF1816G49R90F
R1852	323-0164-00			RES., FXD, FILM: 499 OHM, 1%, 0.50W	75042	CECTO-4990F
R1854	323-0164-00			RES., FXD, FILM: 499 OHM, 1%, 0.50W	75042	CECTO-4990F
R1857	317-0271-00			RES., FXD, CMPSN: 270 OHM, 5%, 0.125W	01121	BB2715
R1862	321-0068-00			RES., FXD, FILM: 49.9 OHM, 1%, 0.125W	91637	MFF1816G49R90F
R1864	321-0068-00			RES., FXD, FILM: 49.9 OHM, 1%, 0.125W	91637	MFF1816G49R90F
R1867	322-0104-00			RES., FXD, FILM: 118 OHM, 1%, 0.25W	91637	MFF1421G118R0F
R1910	315-0621-00			RES., FXD, CMPSN: 620 OHM, 5%, 0.25W	01121	CB6215
R1912	321-0176-00			RES., FXD, FILM: 665 OHM, 1%, 0.125W	91637	MFF1816G665R0F
R1913	321-0223-00			RES., FXD, FILM: 2.05K OHM, 1%, 0.125W	91637	MFF1816G20500F
R1920	315-0301-00			RES., FXD, CMPSN: 300 OHM, 5%, 0.25W	01121	CB3015
R1921	315-0331-03			RES., FXD, CMPSN: 330 OHM, 5%, 0.25W	01121	CB3315
R1923	315-0512-00			RES., FXD, CMPSN: 5.1K OHM, 5%, 0.25W	01121	CB5125
R1924	315-0131-00			RES., FXD, CMPSN: 130 OHM, 5%, 0.25W	01121	CB1315
R1927	315-0302-00			RES., FXD, CMPSN: 3K OHM, 5%, 0.25W	01121	CB3025
R1930	315-0301-00			RES., FXD, CMPSN: 300 OHM, 5%, 0.25W	01121	CB3015
R1931	315-0331-03			RES., FXD, CMPSN: 330 OHM, 5%, 0.25W	01121	CB3315
R1933	315-0680-00			RES., FXD, CMPSN: 68 OHM, 5%, 0.25W	01121	CB6805
R1940	315-0301-00			RES., FXD, CMPSN: 300 OHM, 5%, 0.25W	01121	CB3015
R1941	315-0331-03			RES., FXD, CMPSN: 330 OHM, 5%, 0.25W	01121	CB3315
R1943	315-0680-00			RES., FXD, CMPSN: 68 OHM, 5%, 0.25W	01121	CB6805
R1950	315-0301-00			RES., FXD, CMPSN: 300 OHM, 5%, 0.25W	01121	CB3015
R1951	315-0331-03			RES., FXD, CMPSN: 330 OHM, 5%, 0.25W	01121	CB3315
R1957	315-0302-00			RES., FXD, CMPSN: 3K OHM, 5%, 0.25W	01121	CB3025
R1960	315-0104-00			RES., FXD, CMPSN: 100K OHM, 5%, 0.25W	01121	CB1045
R1963	315-0104-00			RES., FXD, CMPSN: 100K OHM, 5%, 0.25W	01121	CB1045
R1964	321-0259-00			RES., FXD, FILM: 4.87K OHM, 1%, 0.125W	91637	MFF1816G48700F
R1966	321-0182-00			RES., FXD, FILM: 768 OHM, 1%, 0.125W	91637	MFF1816G768R0F
R1968	321-0254-00			RES., FXD, FILM: 4.32K OHM, 1%, 0.125W	91637	MFF1816G43200F
R1970	315-0621-00			RES., FXD, CMPSN: 620 OHM, 5%, 0.25W	01121	CB6215

Replaceable Electrical Parts—7A24 (SN B103000 & UP)

Ckt No.	Tektronix Part No.	Serial/Model No. Eff	Dscont	Name & Description	Mfr Code	Mfr Part Number
R1971	323-0068-00			RES., FXD, FILM: 49.9 OHM, 1%, 0.50W	75042	CECT0-49R90F
R1980	315-0241-00			RES., FXD, CMPSN: 240 OHM, 5%, 0.25W	01121	CB2415
R1982	315-0621-00			RES., FXD, CMPSN: 620 OHM, 5%, 0.25W	01121	CB6215
R1984	315-0392-00			RES., FXD, CMPSN: 3.9K OHM, 5%, 0.25W	01121	CB3925
R1988	315-0152-00			RES., FXD, CMPSN: 1.5K OHM, 5%, 0.25W	01121	CB1525
R1989	315-0101-00			RES., FXD, CMPSN: 100 OHM, 5%, 0.25W	01121	CB1015
R1990	315-0473-00			RES., FXD, CMPSN: 47K OHM, 5%, 0.25W	01121	CB4735
R1991	315-0473-00			RES., FXD, CMPSN: 47K OHM, 5%, 0.25W	01121	CB4735
R2301	311-1268-00			RES., VAR, NONWIR: 10K OHM, 10%, 0.50W	32997	3329P-L58-103
R2303	315-0123-00			RES., FXD, CMPSN: 12K OHM, 5%, 0.25W	01121	CB1235
R2305	311-1263-00			RES., VAR, NONWIR: 1K OHM, 10%, 0.50W	32997	3329P-L58-102
R2307	315-0101-00			RES., FXD, CMPSN: 100 OHM, 5%, 0.25W	01121	CB1015
R2309	307-0132-00			RES., FXD, FILM: 54 OHM, 0.5%, 0.50W	03888	125R500T54R00D
R2310	311-1259-00			RES., VAR, NONWIR: 100 OHM, 10%, 0.50W	32997	3329P-L58-101
R2313	323-0175-00			RES., FXD, FILM: 649 OHM, 1%, 0.50W	75042	CECT0-6490F
R2315	323-0175-00			RES., FXD, FILM: 649 OHM, 1%, 0.50W	75042	CECT0-6490F
R2316	315-0112-00	B103000	B113494	RES., FXD, CMPSN: 1.1K OHM, 5%, 0.25W (NOMINAL VALUE, SELECTED)	01121	CB1125
R2316	315-0152-00	B113495		RES., FXD, CMPSN: 1.5K OHM, 5%, 0.25W (NOMINAL VALUE, SELECTED)	01121	CB1525
R2317	315-0510-00			RES., FXD, CMPSN: 51 OHM, 5%, 0.25W	01121	CB5105
R2318	315-0431-00	B103000	B113494	RES., FXD, CMPSN: 430 OHM, 5%, 0.25W (NOMINAL VALUE, SELECTED)	01121	CB4315
R2318	315-0561-00	B113495		RES., FXD, CMPSN: 560 OHM, 5%, 0.25W (NOMINAL VALUE, SELECTED)	01121	CB5615
R2319	315-0510-00			RES., FXD, CMPSN: 51 OHM, 5%, 0.25W	01121	CB5105
R2320	321-0776-03			RES., FXD, FILM: 3.501K OHM, 0.25%, 0.125W	91637	MFF1816D35010C
R2322	321-0776-03			RES., FXD, FILM: 3.501K OHM, 0.25%, 0.125W	91637	MFF1816D35010C
R2323	321-0776-03			RES., FXD, FILM: 3.501K OHM, 0.25%, 0.125W	91637	MFF1816D35010C
R2325	315-0562-00			RES., FXD, CMPSN: 5.6K OHM, 5%, 0.25W	01121	CB5625
R2326	323-0140-00			RES., FXD, FILM: 280 OHM, 1%, 0.50W	75042	CECT0-2800F
R2327	321-0132-00			RES., FXD, FILM: 232 OHM, 1%, 0.125W	91637	MFF1816G232R0F
R2328	315-0473-00			RES., FXD, CMPSN: 47K OHM, 5%, 0.25W	01121	CB4735
R2329	315-0473-00			RES., FXD, CMPSN: 47K OHM, 5%, 0.25W	01121	CB4735
R2332	311-1266-00			RES., VAR, NONWIR: 2.5K OHM, 10%, 0.50W	32997	3329P-L58-252
R2334	315-0510-00			RES., FXD, CMPSN: 51 OHM, 5%, 0.25W	01121	CB5105
R2336	315-0510-00			RES., FXD, CMPSN: 51 OHM, 5%, 0.25W	01121	CB5105
R2401	321-0068-00			RES., FXD, FILM: 49.9 OHM, 1%, 0.125W	91637	MFF1816G49R90F
R2403	321-0068-00			RES., FXD, FILM: 49.9 OHM, 1%, 0.125W	91637	MFF1816G49R90F
R2410	311-1259-00			RES., VAR, NONWIR: 100 OHM, 10%, 0.50W	32997	3329P-L58-101
R2413	323-0186-00			RES., FXD, FILM: 845 OHM, 1%, 0.50W	75042	CECT0-8450F
R2415	323-0186-00			RES., FXD, FILM: 845 OHM, 1%, 0.50W	75042	CECT0-8450F
R2421	315-0202-00			RES., FXD, CMPSN: 2K OHM, 5%, 0.25W	01121	CB2025
R2422	315-0122-00			RES., FXD, CMPSN: 1.2K OHM, 5%, 0.25W	01121	CB1225
R2423A	311-1854-00			RES., VAR, NONWIR: 1K OHM, 10%, 0.50W	01121	14M403
R2423B	311-1853-00			RES., VAR, NONWIR: 2.5K OHM, 10%, 0.50W	01121	18M838
R2424	311-1269-00			RES., VAR, NONWIR: 20K OHM, 10%, 0.50W	32997	3329P-L58-203
R2426	315-0911-00			RES., FXD, CMPSN: 910 OHM, 5%, 0.25W (NOMINAL VALUE, SELECTED)	01121	CB9115
R2427	315-0510-00			RES., FXD, CMPSN: 51 OHM, 5%, 0.25W	01121	CB5105
R2429	315-0510-00			RES., FXD, CMPSN: 51 OHM, 5%, 0.25W	01121	CB5105
R2430	311-1260-00			RES., VAR, NONWIR: 250 OHM, 10%, 0.50W	32997	3329P-L58-251
R2431	315-0201-00			RES., FXD, CMPSN: 200 OHM, 5%, 0.25W	01121	CB2015
R2434	311-1263-00			RES., VAR, NONWIR: 1K OHM, 10%, 0.50W	32997	3329P-L58-102
R2436	315-0102-00			RES., FXD, CMPSN: 1K OHM, 5%, 0.25W	01121	CB1025
R2438	315-0361-00			RES., FXD, CMPSN: 360 OHM, 5%, 0.25W	01121	CB3615
R2443	315-0162-00			RES., FXD, CMPSN: 1.6K OHM, 5%, 0.25W	01121	CB1625

Replaceable Electrical Parts—7A24 (SN B103000 & UP)

Ckt No.	Tektronix Part No.	Serial/Model No. Eff	Dscont	Name & Description	Mfr Code	Mfr Part Number
R2445	315-0361-00			RES., FXD, CMPSN: 360 OHM, 5%, 0.25W	01121	CB3615
R2450	315-0470-00			RES., FXD, CMPSN: 47 OHM, 5%, 0.25W	01121	CB4705
R2452	323-0129-00			RES., FXD, FILM: 215 OHM, 1%, 0.50W	91637	MFF1226G215R0F
R2455	315-0391-00			RES., FXD, CMPSN: 390 OHM, 5%, 0.25W	01121	CB3915
R2460	315-0470-00			RES., FXD, CMPSN: 47 OHM, 5%, 0.25W	01121	CB4705
R2462	323-0129-00			RES., FXD, FILM: 215 OHM, 1%, 0.50W	91637	MFF1226G215R0F
R2465	315-0391-00			RES., FXD, CMPSN: 390 OHM, 5%, 0.25W	01121	CB3915
R2467	321-0204-00			RES., FXD, FILM: 1.3K OHM, 1%, 0.125W	91637	MFF1816G13000F
R2468	321-0211-00			RES., FXD, FILM: 1.54K OHM, 1%, 0.125W	91637	MFF1816G15400F
R2470	315-0222-00			RES., FXD, CMPSN: 2.2K OHM, 5%, 0.25W	01121	CB2225
R2473	315-0362-00			RES., FXD, CMPSN: 3.6K OHM, 5%, 0.25W	01121	CB3625
R2474	315-0202-00			RES., FXD, CMPSN: 2K OHM, 5%, 0.25W	01121	CB2025
R2480	315-0202-00			RES., FXD, CMPSN: 2K OHM, 5%, 0.25W	01121	CB2025
R2483	315-0362-00			RES., FXD, CMPSN: 3.6K OHM, 5%, 0.25W	01121	CB3625
R2484	315-0202-00			RES., FXD, CMPSN: 2K OHM, 5%, 0.25W	01121	CB2025
R2486	315-0471-00			RES., FXD, CMPSN: 470 OHM, 5%, 0.25W	01121	CB4715
R2487	311-1320-00	B010100	B115549	RES., VAR, NONWIR: 5K OHM, 1W, W/SW (FURNISHED AS A UNIT WITH S2465)	12697	381CM-39700
R2487	311-1320-01	B115550		RES., VAR, NONWIR: 5K OHM, 10%, 1W, SPST SW (FURNISHED AS A UNIT WITH S2465)	12697	CM43494
R2488	315-0223-00			RES., FXD, CMPSN: 22K OHM, 5%, 0.25W	01121	CB2235
R2489	315-0273-00			RES., FXD, CMPSN: 27K OHM, 5%, 0.25W	01121	CB2735
R2501	323-0135-00			RES., FXD, FILM: 249 OHM, 1%, 0.50W	91637	MFF1226G249R0F
R2503	321-0068-00			RES., FXD, FILM: 49.9 OHM, 1%, 0.125W	91637	MFF1816G49R90F
R2504	321-0068-00			RES., FXD, FILM: 49.9 OHM, 1%, 0.125W	91637	MFF1816G49R90F
R2510	323-0128-00			RES., FXD, FILM: 210 OHM, 1%, 0.50W	75042	CECT0-2100F
R2512	323-0128-00			RES., FXD, FILM: 210 OHM, 1%, 0.50W	75042	CECT0-2100F
R2515	311-1261-00			RES., VAR, NONWIR: 500 OHM, 10%, 0.50W	32997	3329P-L58-501
R2550	315-0751-00			RES., FXD, CMPSN: 750 OHM, 5%, 0.25W	01121	CB7515
R2551	315-0132-00			RES., FXD, CMPSN: 1.3K OHM, 5%, 0.25W	01121	CB1325
R2555	315-0473-00			RES., FXD, CMPSN: 47K OHM, 5%, 0.25W	01121	CB4735
R2560	311-1260-00			RES., VAR, NONWIR: 250 OHM, 10%, 0.50W	32997	3329P-L58-251
R2562	311-1260-00			RES., VAR, NONWIR: 250 OHM, 10%, 0.50W	32997	3329P-L58-251
R2750	321-0068-00			RES., FXD, FILM: 49.9 OHM, 1%, 0.125W	91637	MFF1816G49R90F
R2752	323-0164-00			RES., FXD, FILM: 499 OHM, 1%, 0.50W	75042	CECT0-4990F
R2754	323-0164-00			RES., FXD, FILM: 499 OHM, 1%, 0.50W	75042	CECT0-4990F
R2762	321-0068-00			RES., FXD, FILM: 49.9 OHM, 1%, 0.125W	91637	MFF1816G49R90F
R2764	321-0068-00			RES., FXD, FILM: 49.9 OHM, 1%, 0.125W	91637	MFF1816G49R90F
R2767	322-0104-00			RES., FXD, FILM: 118 OHM, 1%, 0.25W	91637	MFF1421G118R0F
R2850	321-0068-00			RES., FXD, FILM: 49.9 OHM, 1%, 0.125W	91637	MFF1816G49R90F
R2852	323-0164-00			RES., FXD, FILM: 499 OHM, 1%, 0.50W	75042	CECT0-4990F
R2854	323-0164-00			RES., FXD, FILM: 499 OHM, 1%, 0.50W	75042	CECT0-4990F
R2857	317-0271-00			RES., FXD, CMPSN: 270 OHM, 5%, 0.125W	01121	BB2715
R2862	321-0068-00			RES., FXD, FILM: 49.9 OHM, 1%, 0.125W	91637	MFF1816G49R90F
R2864	321-0068-00			RES., FXD, FILM: 49.9 OHM, 1%, 0.125W	91637	MFF1816G49R90F
R2867	322-0104-00			RES., FXD, FILM: 118 OHM, 1%, 0.25W	91637	MFF1421G118R0F
R2910	315-0621-00			RES., FXD, CMPSN: 620 OHM, 5%, 0.25W	01121	CB6215
R2912	321-0176-00			RES., FXD, FILM: 665 OHM, 1%, 0.125W	91637	MFF1816G665R0F
R2913	321-0223-00			RES., FXD, FILM: 2.05K OHM, 1%, 0.125W	91637	MFF1816G20500F
R2920	315-0301-00			RES., FXD, CMPSN: 300 OHM, 5%, 0.25W	01121	CB3015
R2921	315-0331-03			RES., FXD, CMPSN: 330 OHM, 5%, 0.25W	01121	CB3315
R2923	315-0512-00			RES., FXD, CMPSN: 5.1K OHM, 5%, 0.25W	01121	CB5125
R2924	315-0131-00			RES., FXD, CMPSN: 130 OHM, 5%, 0.25W	01121	CB1315
R2927	315-0302-00			RES., FXD, CMPSN: 3K OHM, 5%, 0.25W	01121	CB3025
R2930	315-0301-00			RES., FXD, CMPSN: 300 OHM, 5%, 0.25W	01121	CB3015
R2931	315-0331-03			RES., FXD, CMPSN: 330 OHM, 5%, 0.25W	01121	CB3315
R2933	315-0680-00			RES., FXD, CMPSN: 68 OHM, 5%, 0.25W	01121	CB6805

Replaceable Electrical Parts—7A24 (SN B103000 & UP)

Ckt No.	Tektronix Part No.	Serial/Model No. Eff	Dscont	Name & Description	Mfr Code	Mfr Part Number
R2940	315-0301-00			RES.,FXD,CMPSN:300 OHM,5%,0.25W	01121	CB3015
R2941	315-0331-03			RES.,FXD,CMPSN:330 OHM,5%,0.25W	01121	CB3315
R2943	315-0680-00			RES.,FXD,CMPSN:68 OHM,5%,0.25W	01121	CB6805
R2950	315-0301-00			RES.,FXD,CMPSN:300 OHM,5%,0.25W	01121	CB3015
R2951	315-0331-03			RES.,FXD,CMPSN:330 OHM,5%,0.25W	01121	CB3315
R2957	315-0302-00			RES.,FXD,CMPSN:3K OHM,5%,0.25W	01121	CB3025
R2960	315-0104-00			RES.,FXD,CMPSN:100K OHM,5%,0.25W	01121	CB1045
R2963	315-0104-00			RES.,FXD,CMPSN:100K OHM,5%,0.25W	01121	CB1045
R2964	321-0259-00			RES.,FXD,FILM:4.87K OHM,1%,0.125W	91637	MFF1816G48700F
R2966	321-0182-00			RES.,FXD,FILM:768 OHM,1%,0.125W	91637	MFF1816G768ROF
R2968	321-0254-00			RES.,FXD,FILM:4.32K OHM,1%,0.125W	91637	MFF1816G43200F
R2970	315-0621-00			RES.,FXD,CMPSN:620 OHM,5%,0.25W	01121	CB6215
R2971	323-0068-00			RES.,FXD,FILM:49.9 OHM,1%,0.50W	75042	CECTO-49R90F
RT1420	307-0124-00			RES.,THERMAL:5K OHM,10%	50157	1D1618
RT2420	307-0124-00			RES.,THERMAL:5K OHM,10%	50157	1D1618
S22A,B	260-1833-00			SWITCH,SLIDE:DPDT	82389	11P-1092
S30A,B	262-0926-00			SWITCH,WIRED:FREQ SOURCE & DISPLAY MODE	80009	262-0926-00
S100A-C	263-1080-00			SW CAM ACTR AS:VOLTS/DIV	80009	263-1080-00
S1465	-----			(FURNISHED AS A UNIT WITH R1487)		
S2465	-----			(FURNISHED AS A UNIT WITH R2487)		
T1300	119-0418-00			CPLR,XMSN LINE: BALUN	80009	119-0418-00
T1301	119-0418-00			CPLR,XMSN LINE: BALUN	80009	119-0418-00
T1527	276-0557-00			CORE,FERRITE:0.23 ID X 0.12 ID X 0.125	78488	57-0131
T1550	120-0286-00	XB114735		XFMR,TOROID:2 TURNS,BIFILAR	80009	120-0286-00
T2300	119-0418-00			CPLR,XMSN LINE: BALUN	80009	119-0418-00
T2301	119-0418-00			CPLR,XMSN LINE: BALUN	80009	119-0418-00
T2527	276-0557-00			CORE,FERRITE:0.23 ID X 0.12 ID X 0.125	78488	57-0131
T2550	120-0286-00	XB114735		XFMR,TOROID:2 TURNS,BIFILAR	80009	120-0286-00
U1350	155-0078-13	B103000	B113599	MICROCIRCUIT,LI:ML,VERTICAL AMPL,SEL	80009	155-0078-13
U1350	155-0078-10	B113600		MICROCIRCUIT,LI:ML,VERTICAL AMPLIFIER	80009	155-0078-10
U1450	155-0078-10			MICROCIRCUIT,LI:ML,VERTICAL AMPLIFIER	80009	155-0078-10
U1550	155-0078-13	B103000	B113599	MICROCIRCUIT,LI:ML,VERTICAL AMPL,SEL	80009	155-0078-13
U1550	155-0078-10	B113600		MICROCIRCUIT,LI:ML,VERTICAL AMPLIFIER	80009	155-0078-10
U1750	155-0078-11	B103000	B113599	MICROCIRCUIT,LI:ML,VERTICAL AMPLIFIER,SEL	80009	155-0078-11
U1750	155-0078-10	B113600		MICROCIRCUIT,LI:ML,VERTICAL AMPLIFIER	80009	155-0078-10
U1850	155-0078-11	B103000	B113599	MICROCIRCUIT,LI:ML,VERTICAL AMPLIFIER,SEL	80009	155-0078-11
U1850	155-0078-10	B113600		MICROCIRCUIT,LI:ML,VERTICAL AMPLIFIER	80009	155-0078-10
U2350	155-0078-10			MICROCIRCUIT,LI:ML,VERTICAL AMPLIFIER	80009	155-0078-10
U2450	155-0078-10			MICROCIRCUIT,LI:ML,VERTICAL AMPLIFIER	80009	155-0078-10
U2550	155-0078-13	B103000	B113599	MICROCIRCUIT,LI:ML,VERTICAL AMPL,SEL	80009	155-0078-13
U2550	155-0078-10	B113600		MICROCIRCUIT,LI:ML,VERTICAL AMPLIFIER	80009	155-0078-10
U2750	155-0078-11	B103000	B113599	MICROCIRCUIT,LI:ML,VERTICAL AMPLIFIER,SEL	80009	155-0078-11
U2750	155-0078-10	B113600		MICROCIRCUIT,LI:ML,VERTICAL AMPLIFIER	80009	155-0078-10
U2850	155-0078-11	B103000	B113599	MICROCIRCUIT,LI:ML,VERTICAL AMPLIFIER,SEL	80009	155-0078-11
U2850	155-0078-10	B113600		MICROCIRCUIT,LI:ML,VERTICAL AMPLIFIER	80009	155-0078-10

DIAGRAMS AND CIRCUIT BOARD ILLUSTRATIONS

Symbols and Reference Designators

Electrical components shown on the diagrams are in the following units unless noted otherwise:

Capacitors = Values one or greater are in picofarads (pF).
 Values less than one are in microfarads (μF).

Resistors = Ohms (Ω).

Symbols used on the diagrams are based on ANSI Standard Y32.2-1975.

Logic symbology is based on ANSI Y32.14-1973 in terms of positive logic. Logic symbols depict the logic function performed and may differ from the manufacturer's data.

The following prefix letters are used as reference designators to identify components or assemblies on the diagrams.

A	Assembly, separable or repairable (circuit board, etc.)	H	Heat dissipating device (heat sink, heat radiator, etc.)	RT	Thermistor
AT	Attenuator, fixed or variable	HR	Heater	S	Switch
B	Motor	HY	Hybrid circuit	T	Transformer
BT	Battery	J	Connector, stationary portion	TC	Thermocouple
C	Capacitor, fixed or variable	K	Relay	TP	Test point
CB	Circuit breaker	L	Inductor, fixed or variable	U	Assembly, inseparable or non-repairable (integrated circuit, etc.)
CR	Diode, signal or rectifier	LR	Inductor/resistor combination	V	Electron tube
DL	Delay line	M	Meter	VR	Voltage regulator (zener diode, etc.)
DS	Indicating device (lamp)	P	Connector, movable portion	Y	Crystal
E	Spark Gap	Q	Transistor or silicon-controlled rectifier	Z	Phase shifter
F	Fuse	R	Resistor, fixed or variable		
FL	Filter				

The following special symbols are used on the diagrams:

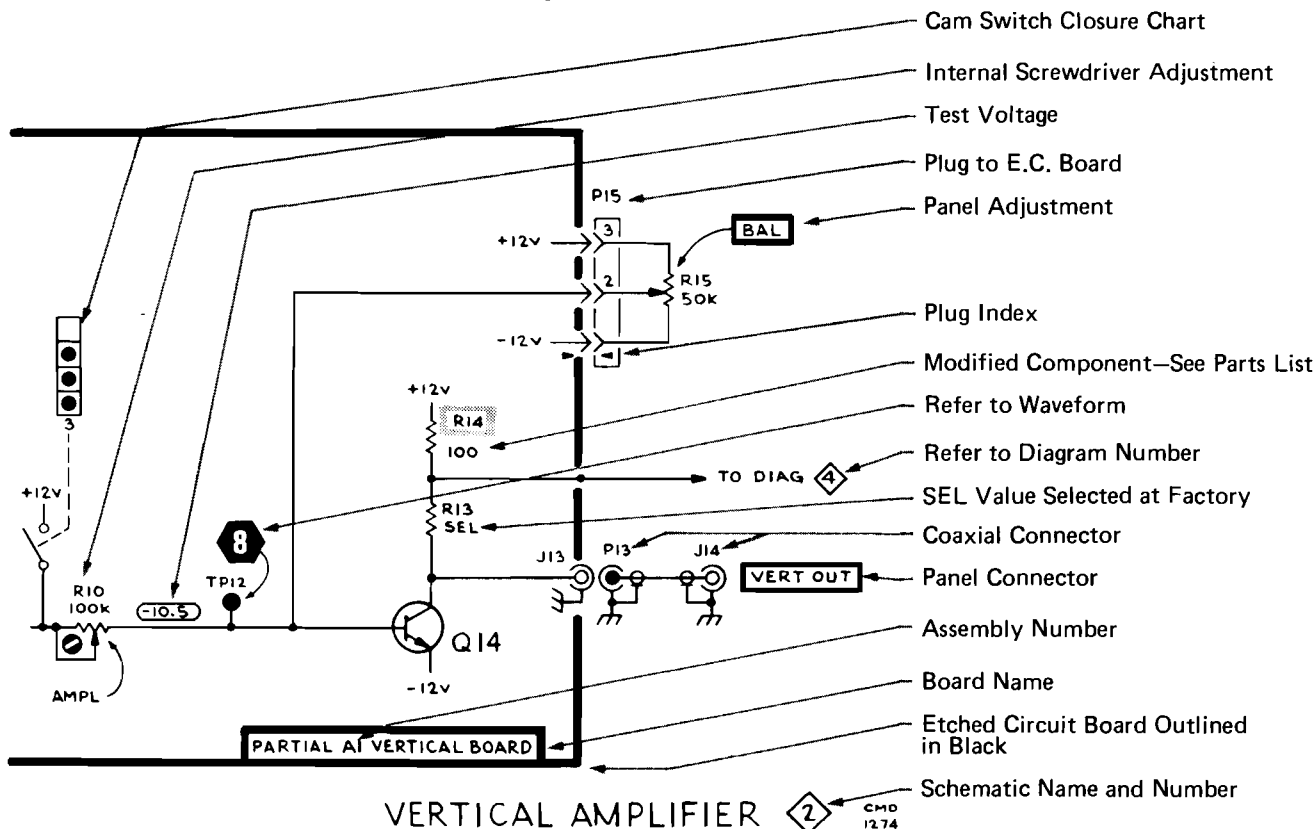

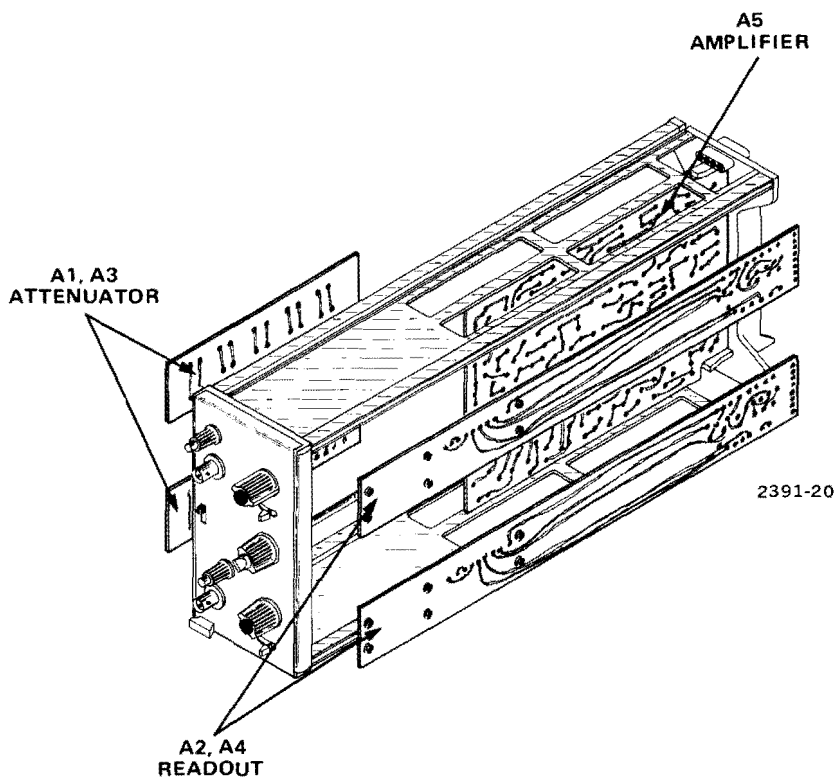
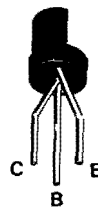
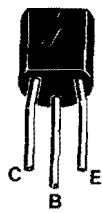
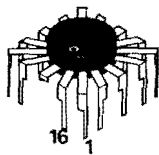

Figure 8-1. Circuit board locator.



PLASTIC-CASE TRANSISTORS



INTEGRATED
CIRCUIT

C2391-5

Figure 8-2. Semiconductor lead configurations.

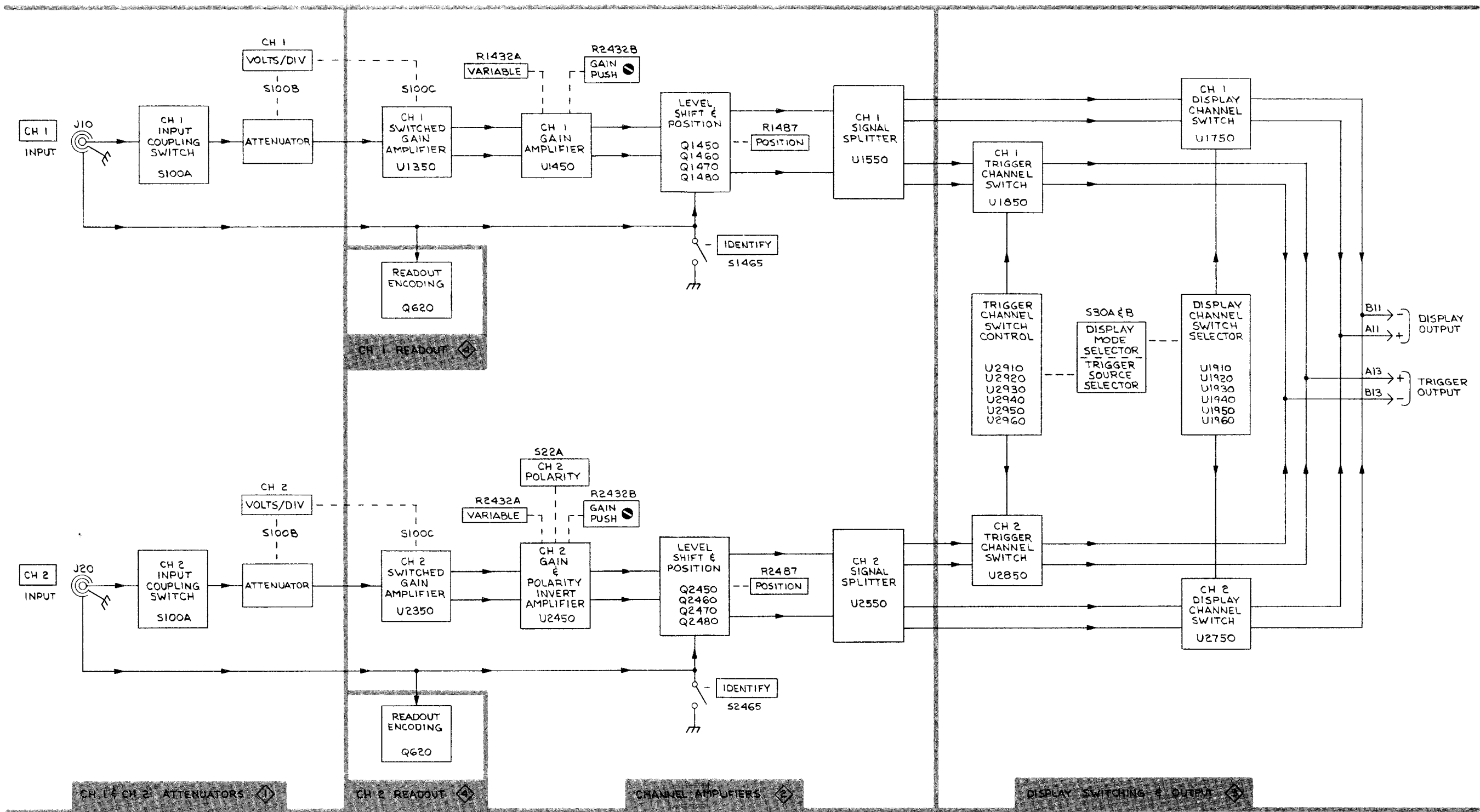

BLOCK DIAGRAM

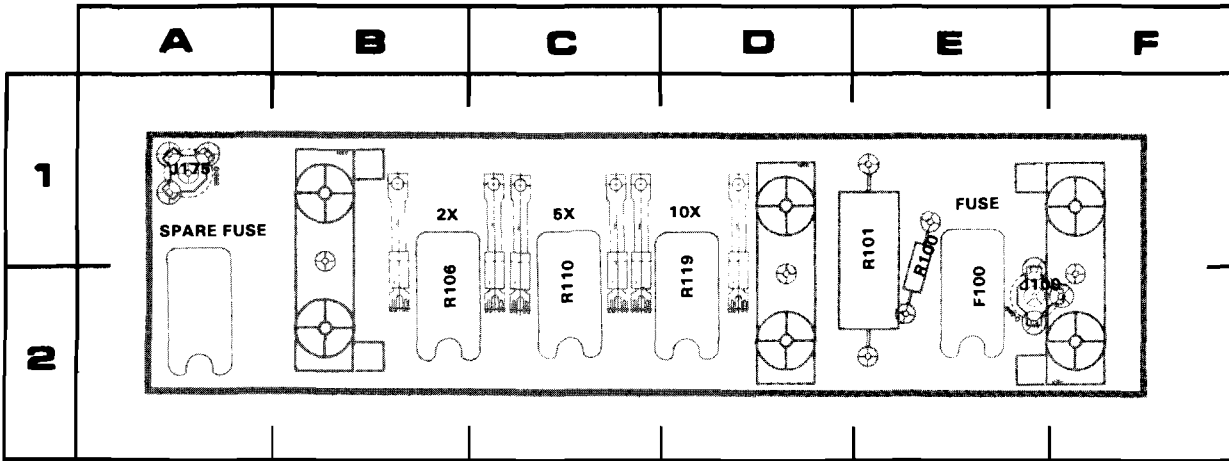

2391-21

Figure 8-3. A1 and A3—Attenuator circuit board assembly.

CKT NO	GRID COORD	CKT NO	GRID COORD
F100	2E	R100	1E
		R101	1E
		R106	2B
J100	2F	R110	2C
J175	1A	R119	2D

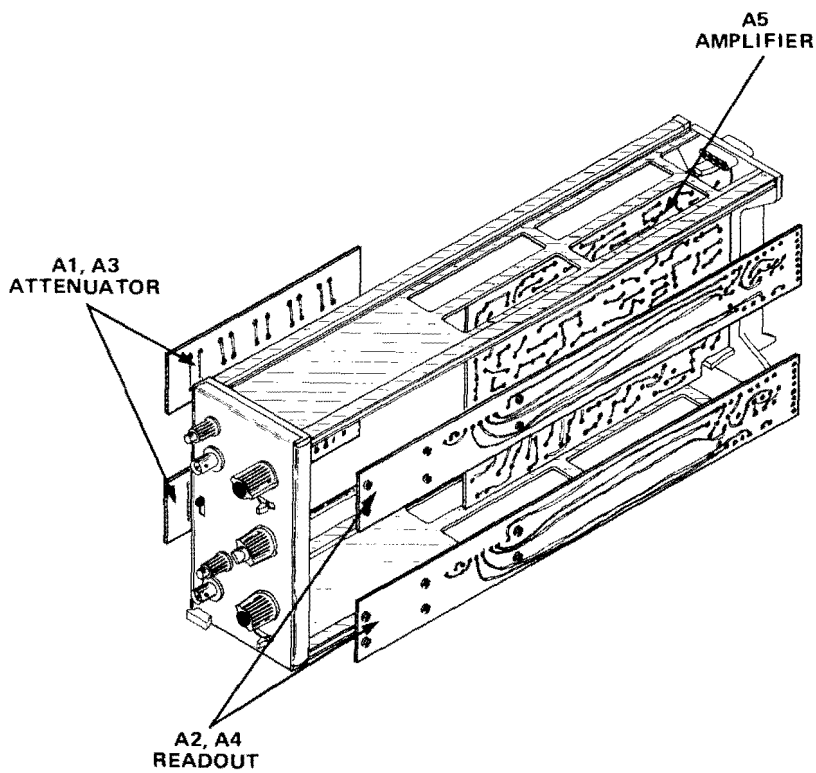

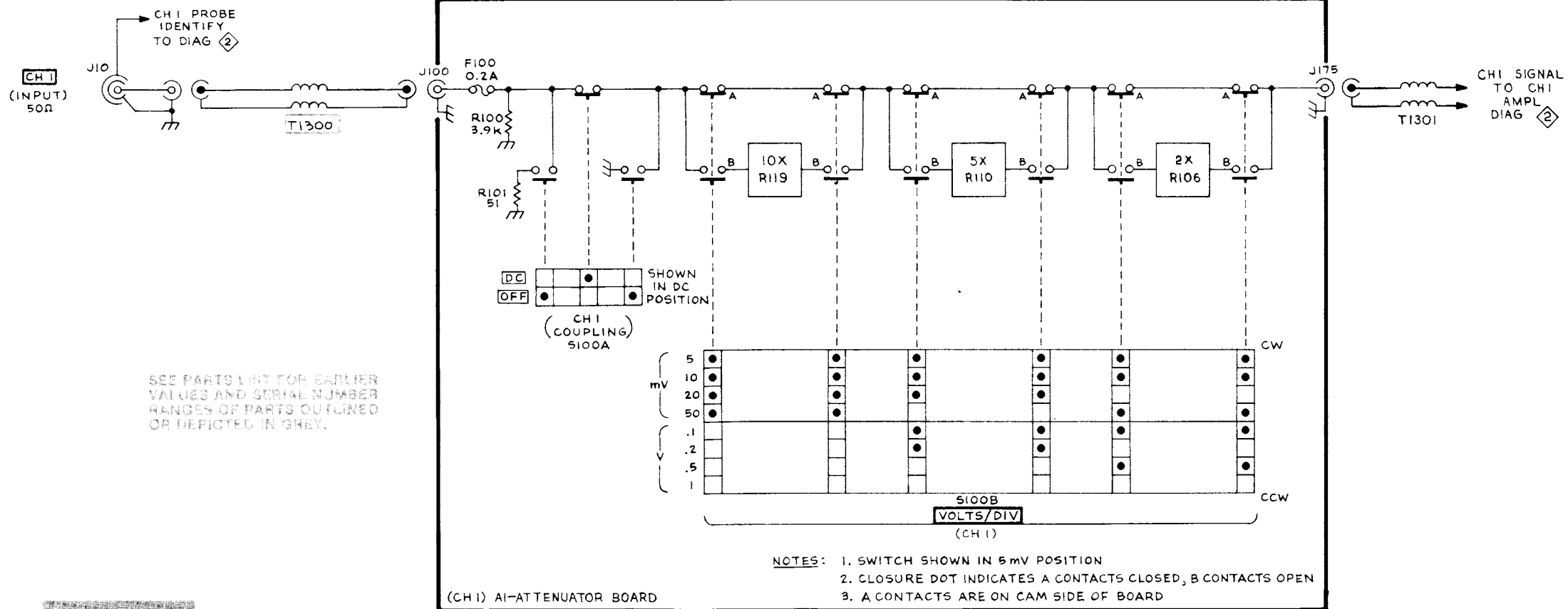

CH 1 ATTENUATOR

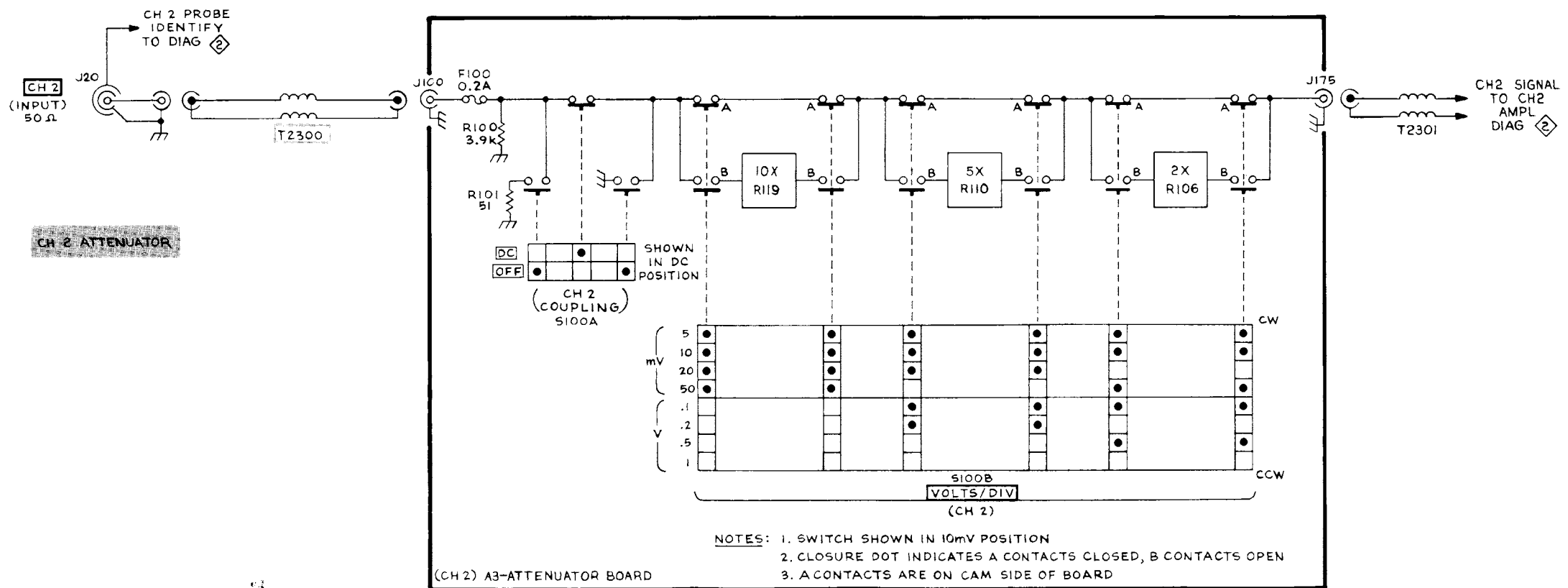

CH 2 ATTENUATOR

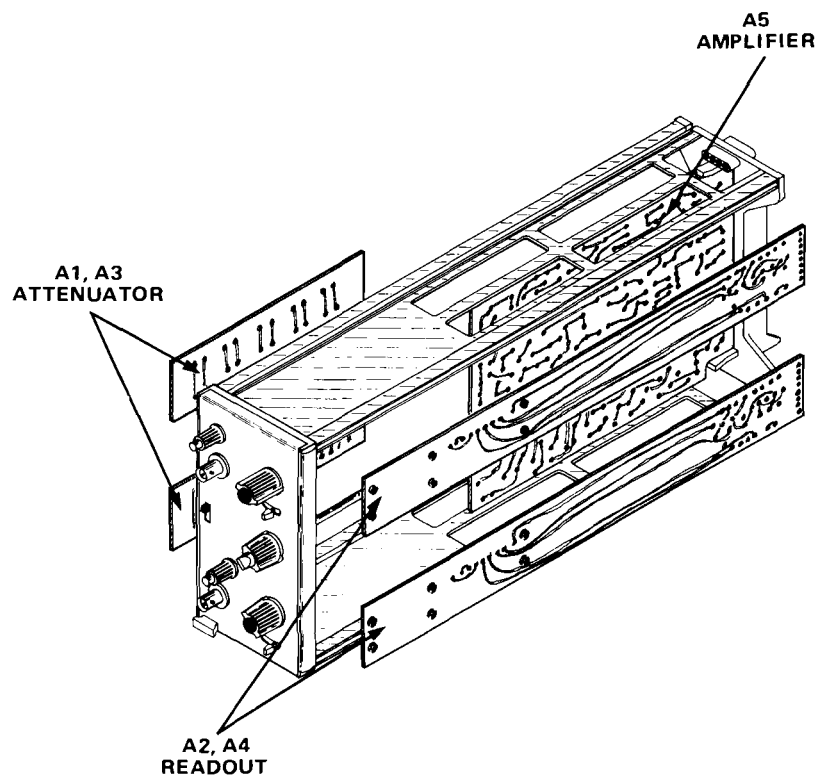

VOLTAGE AND WAVEFORM CONDITIONS

The voltages and waveforms shown were obtained with the 7A24 controls set as follows:

CH 1 and CH 2 VOLTS/DIV, 5 mV; CH 1 and CH 2 Input switches, DC; CH 1 and CH 2 POSITION, center trace on graticule; DISPLAY MODE, CH 1; TRIGGER SOURCE, MODE; CH 2 POLARITY, +UP.

Waveform Conditions. The waveforms shown below were obtained using a test oscilloscope system with 10 M Ω input impedance and at least 30 MHz bandwidth (Tektronix 7603, 7B53A Time Base, and 7A13 Differential Comparator equipped with 10X probe). A 1 kHz, 20 mV into 50 Ω signal was fed to CH 1 of the 7A24.

Voltage Conditions. The voltages shown on the diagram were obtained using a digital multimeter with a 10 m Ω input impedance (Tektronix DM501 or Tektronix 7D13 Digital Multimeter used with readout equipped, 7000-series oscilloscope). The 7A24 CH 2 VOLTS/DIV is set to 10 mV.

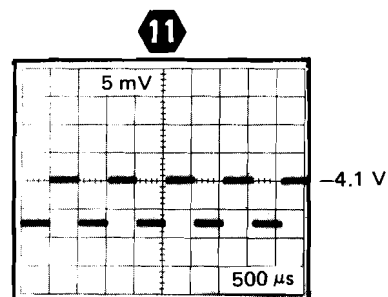
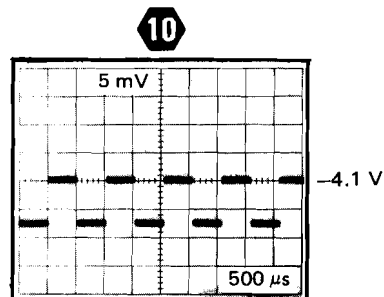
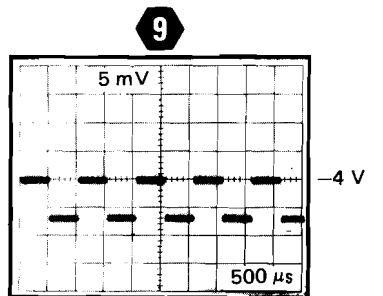
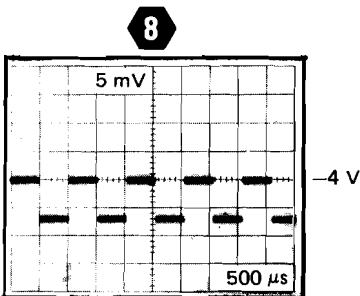
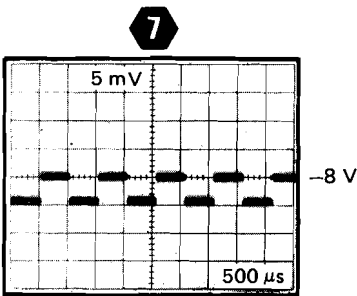
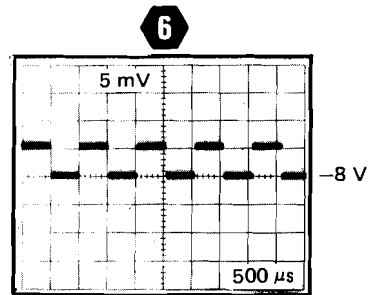
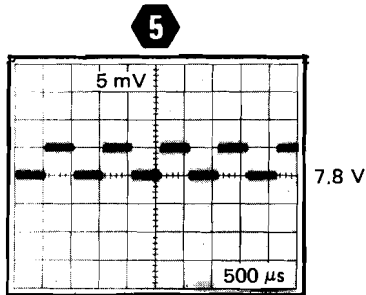
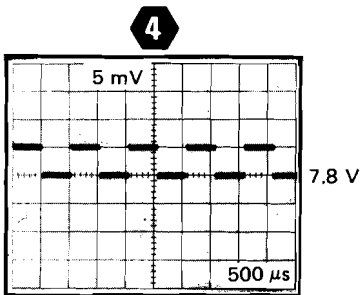
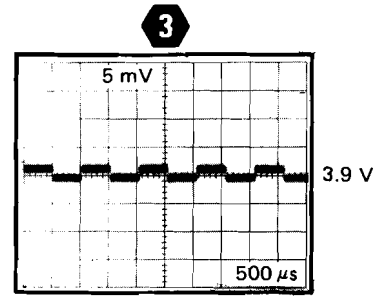
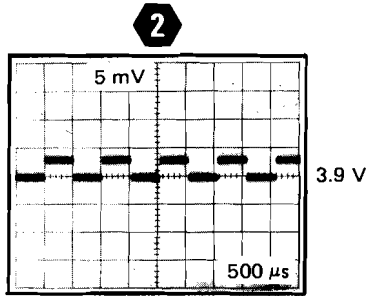
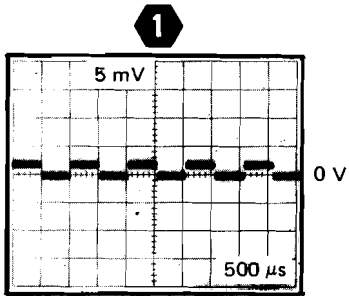

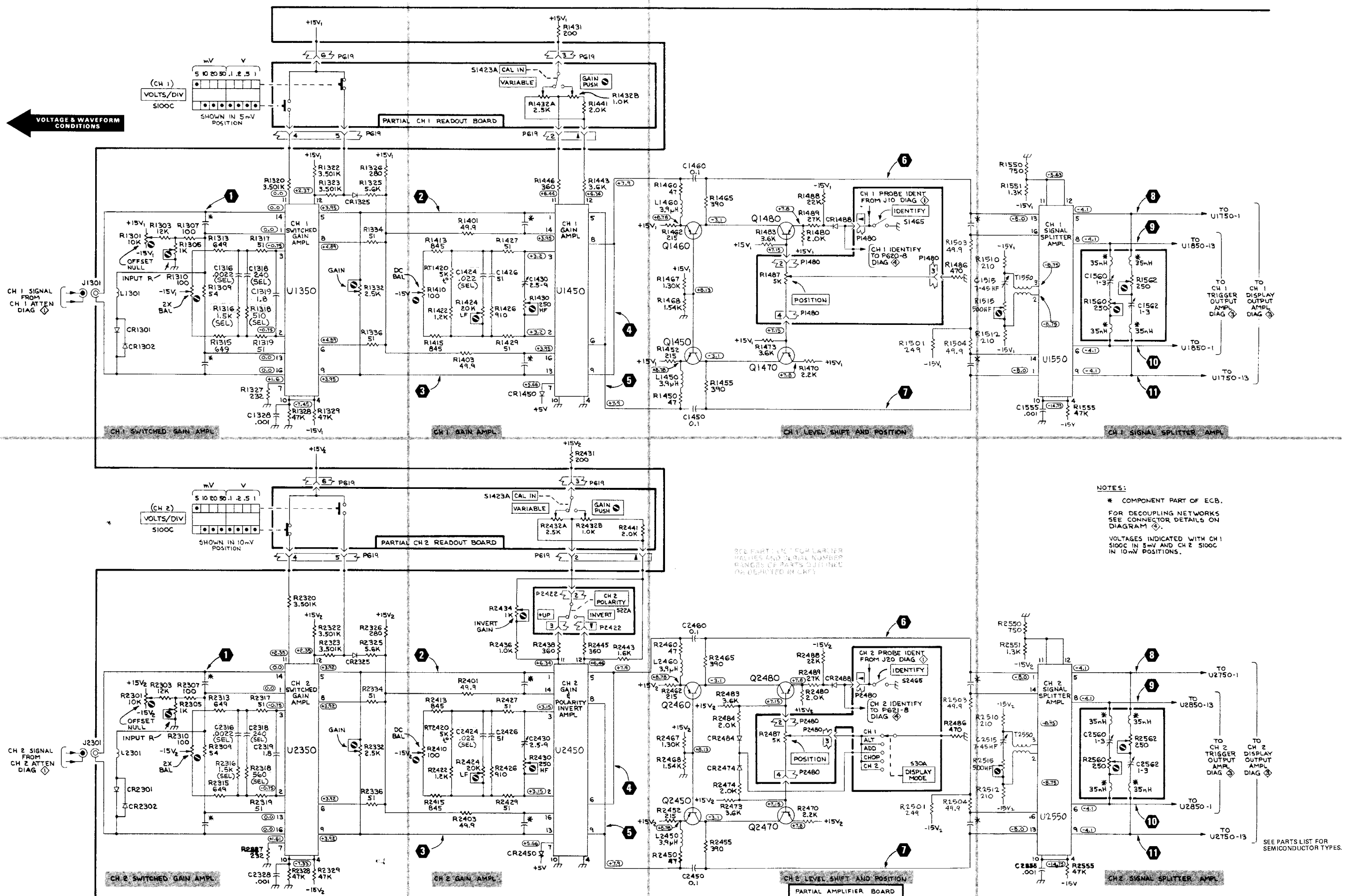

VOLTAGE & WAVEFORM CONDITIONS

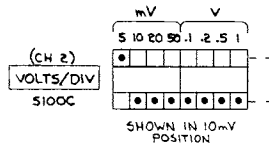
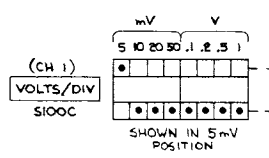

NOTES:
* COMPONENT PART OF ECB.
FOR DECOUPLING NETWORKS SEE CONNECTOR DETAILS ON DIAGRAM (4).
VOLTAGES INDICATED WITH CH 1 S100C IN 5mV AND CH 2 S100C IN 10mV POSITIONS.

SEE PARTS LIST FOR PART NUMBER VALUES AND SERIAL NUMBER RANGES OF PARTS WHICH ARE OR DELETED IN COPY

SEE PARTS LIST FOR SEMICONDUCTOR TYPES.

CH 1 AND CH 2 AMPLIFIERS

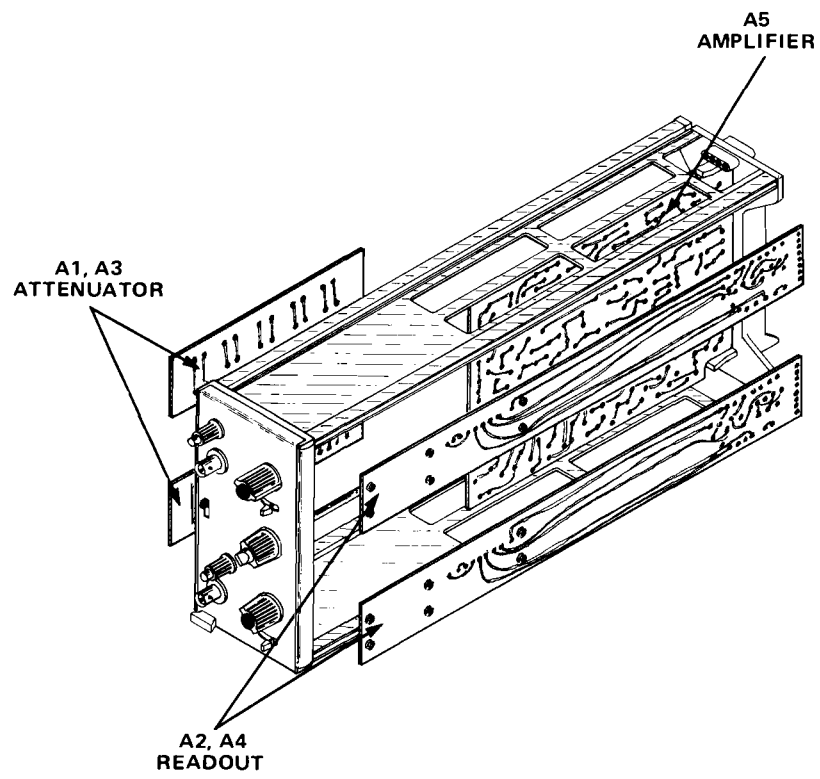

VOLTAGE AND WAVEFORM CONDITIONS

The voltages and waveforms shown were obtained with the 7A24 controls set as follows:

CH 1 and CH 2 VOLTS/DIV, 5 mV; CH 1 and CH 2 Input switches, DC; CH 1 and CH 2 POSITION, center trace on graticule; DISPLAY MODE, CH 1; TRIGGER SOURCE, MODE; CH 2 POLARITY, +UP.

Waveform Conditions. The waveforms shown below were obtained using a test oscilloscope system with 10 M Ω input impedance and at least 30 MHz bandwidth (Tektronix 7603, 7B53A Time Base, and 7A13 Differential Comparator equipped with 10X probe). A 1 kHz, 20 mV into 50 Ω signal was fed to CH 1 of the 7A24.

Voltage Conditions. The voltages shown on the diagram were obtained using a digital multimeter with a 10 m Ω input impedance (Tektronix DM501 or Tektronix 7D13 Digital Multimeter used with readout equipped, 7000-series oscilloscope). The 7A24 CH 2 VOLTS/DIV is set to 10 mV.

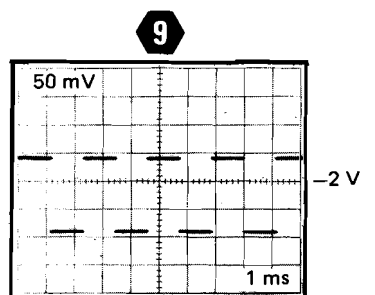
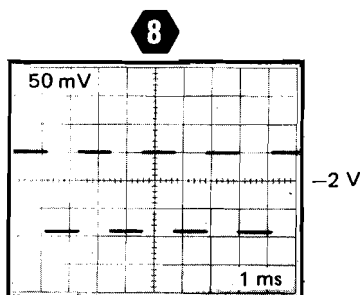
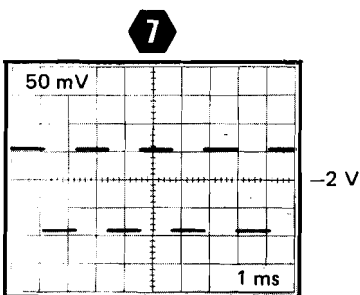
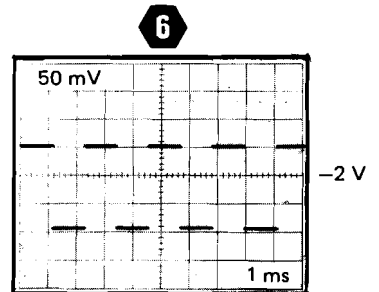
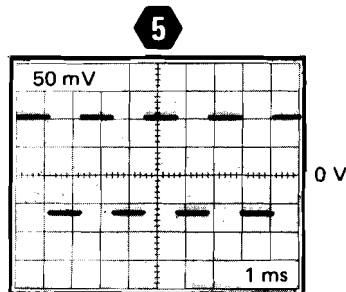
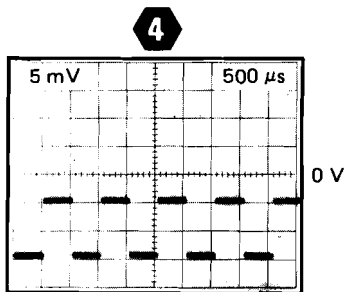
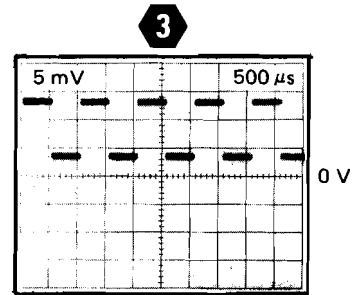
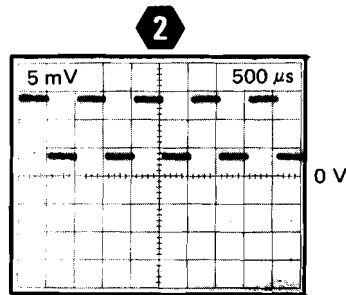
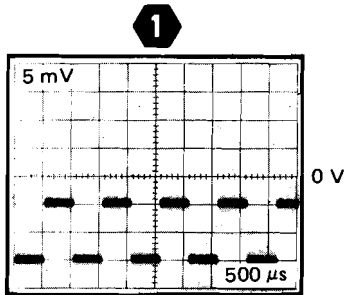

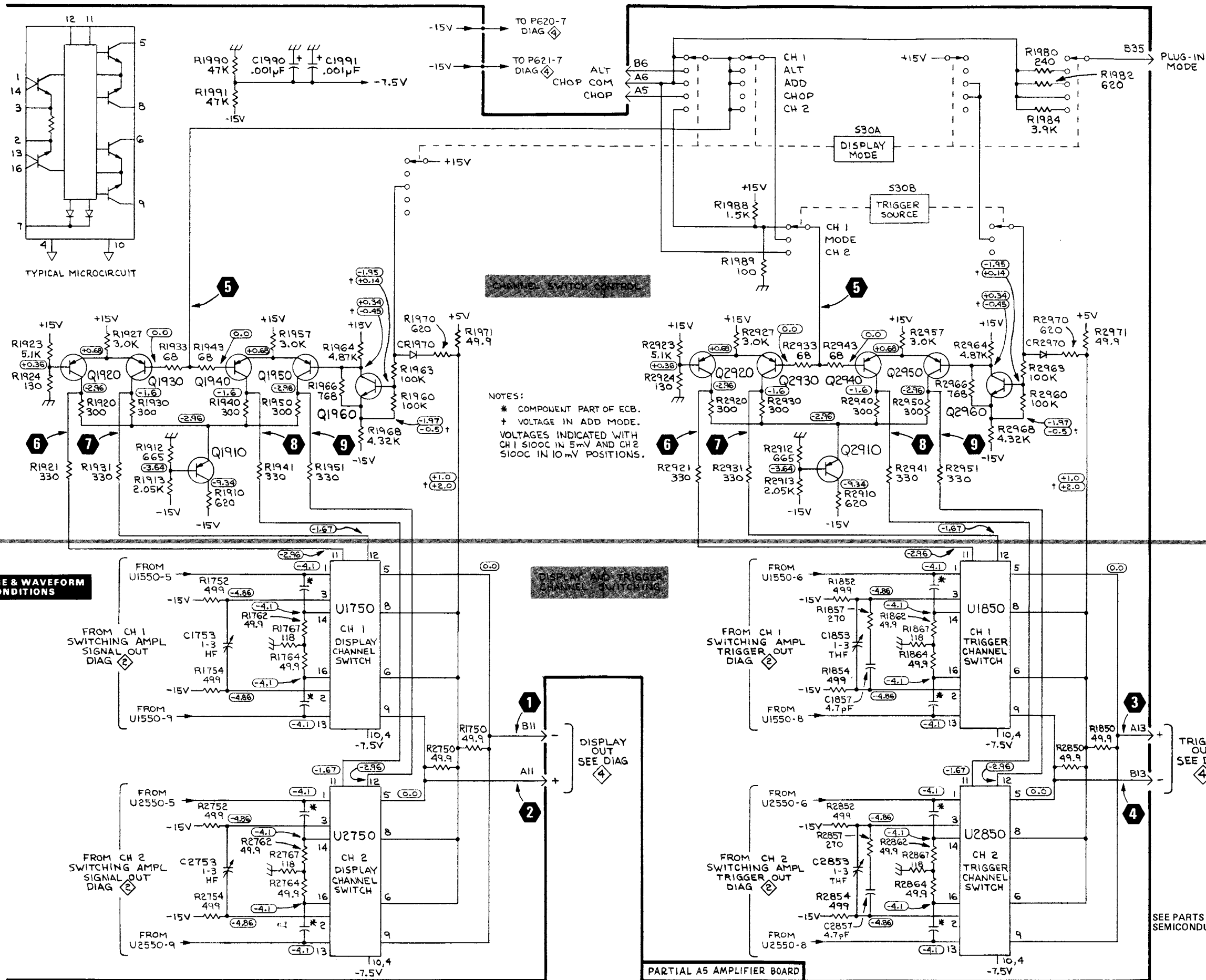

NOTES:
 * COMPONENT PART OF ECB.
 + VOLTAGE IN ADD MODE.
 VOLTAGES INDICATED WITH
 CH 1 S100C IN 5mV AND CH 2
 S100C IN 10mV POSITIONS.

VOLTAGE & WAVEFORM
 CONDITIONS

SEE PARTS LIST FOR
 SEMICONDUCTOR TYPES.

7A24 (SN B103000 & UP)

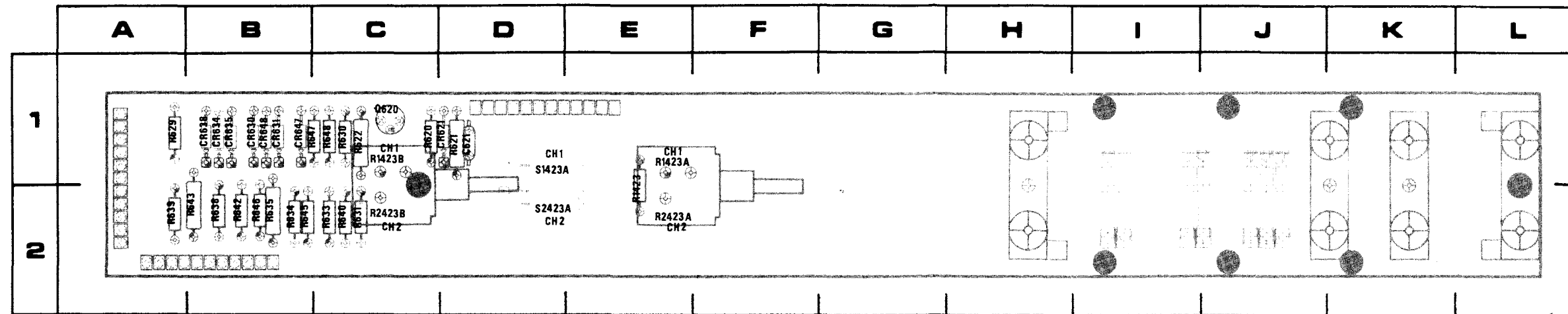

2391-24

Figure 8-6. A2 and A4—Readout circuit board assembly.

CKT NO	GRID COORD	CKT NO	GRID COORD
C621	1D	R633	2C
		R634	2B
CR621	1C	R635	2B
CR630	1B	R636	2B
CR631	1B	R638	2B
CR634	1B	R639	2A
CR635	1B	R640	2C
CR638	1B	R642	2B
CR647	1B	R643	2A
CR648	1B	R645	2B
		R647	1B
		R648	1C
Q620	1C	R1423A	1E
		R1423B	1C
R620	1C	R2423A	2E
R621	1D	R2423B	2C
R622	1C		
R629	1A		
R630	1C	S1423	1D
R631	2C	S2423	2D

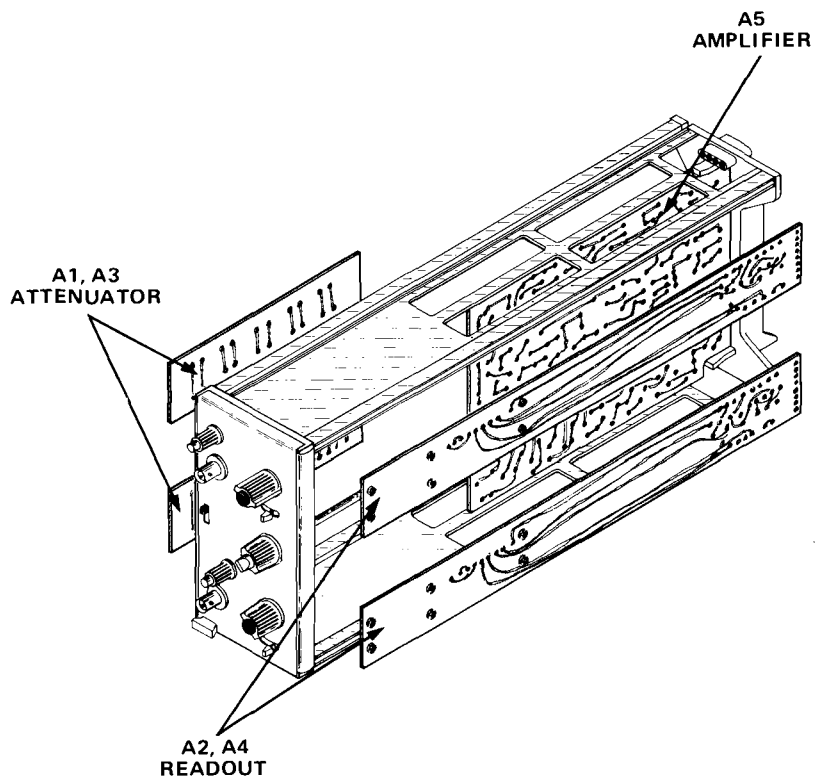

REPLACEABLE MECHANICAL PARTS

PARTS ORDERING INFORMATION

Replacement parts are available from or through your local Tektronix, Inc. Field Office or representative.

Changes to Tektronix instruments are sometimes made to accommodate improved components as they become available, and to give you the benefit of the latest circuit improvements developed in our engineering department. It is therefore important, when ordering parts, to include the following information in your order: Part number, instrument type or number, serial number, and modification number if applicable.

If a part you have ordered has been replaced with a new or improved part, your local Tektronix, Inc. Field Office or representative will contact you concerning any change in part number.

Change information, if any, is located at the rear of this manual.

SPECIAL NOTES AND SYMBOLS

X000 Part first added at this serial number
00X Part removed after this serial number

FIGURE AND INDEX NUMBERS

Items in this section are referenced by figure and index numbers to the illustrations.

INDENTATION SYSTEM

This mechanical parts list is indented to indicate item relationships. Following is an example of the indentation system used in the description column.

```

1 2 3 4 5
Name & Description
Assembly and/or Component
Attaching parts for Assembly and/or Component
    - - - * - - -
Detail Part of Assembly and/or Component
Attaching parts for Detail Part
    - - - * - - -
Parts of Detail Part
Attaching parts for Parts of Detail Part
    - - - * - - -
  
```

Attaching Parts always appear in the same indentation as the item it mounts, while the detail parts are indented to the right. Indented items are part of, and included with, the next higher indentation. The separation symbol - - - * - - - indicates the end of attaching parts.

Attaching parts must be purchased separately, unless otherwise specified.

ITEM NAME

In the Parts List, an Item Name is separated from the description by a colon (:). Because of space limitations, an Item Name may sometimes appear as incomplete. For further Item Name identification, the U.S. Federal Cataloging Handbook H6-1 can be utilized where possible.

ABBREVIATIONS

"	INCH	ELCTRN	ELECTRON	IN	INCH	SE	SINGLE END
#	NUMBER SIZE	ELEC	ELECTRICAL	INCAND	INCANDESCENT	SECT	SECTION
ACTR	ACTUATOR	ELCTLT	ELECTROLYTIC	INSUL	INSULATOR	SEMICOND	SEMICONDUCTOR
ADPTR	ADAPTER	ELEM	ELEMENT	INTL	INTERNAL	SHLD	SHIELD
ALIGN	ALIGNMENT	EPL	ELECTRICAL PARTS LIST	LPHLDR	LAMPHOLDER	SHLDR	SHOULDERED
AL	ALUMINUM	EQPT	EQUIPMENT	MACH	MACHINE	SKT	SOCKET
ASSEM	ASSEMBLED	EXT	EXTERNAL	MECH	MECHANICAL	SL	SLIDE
ASSY	ASSEMBLY	FIL	FILLISTER HEAD	MTG	MOUNTING	SLFLKGG	SELF-LOCKING
ATTEN	ATTENUATOR	FLEX	FLEXIBLE	NIP	NIPPLE	SLVG	SLEEVING
AWG	AMERICAN WIRE GAGE	FLH	FLAT HEAD	NON WIRE	NOT WIRE WOUND	SPR	SPRING
BD	BOARD	FLTR	FILTER	OBD	ORDER BY DESCRIPTION	SQ	SQUARE
BRKT	BRACKET	FR	FRAME or FRONT	OD	OUTSIDE DIAMETER	SST	STAINLESS STEEL
BRS	BRASS	FSTNR	FASTENER	OVH	OVAL HEAD	STL	STEEL
BRZ	BRONZE	FT	FOOT	PH BRZ	PHOSPHOR BRONZE	SW	SWITCH
BSHG	BUSHING	FXD	FIXED	PL	PLAIN or PLATE	T	TUBE
CAB	CABINET	GSKT	GASKET	PLSTC	PLASTIC	TERM	TERMINAL
CAP	CAPACITOR	HDL	HANDLE	PN	PART NUMBER	THD	THREAD
CER	CERAMIC	HEX	HEXAGON	PNH	PAN HEAD	THK	THICK
CHAS	CHASSIS	HEX HD	HEXAGONAL HEAD	PWR	POWER	TNSN	TENSION
CKT	CIRCUIT	HEX SOC	HEXAGONAL SOCKET	RCPT	RECEPTACLE	TPG	TAPPING
COMP	COMPOSITION	HLCPS	HELICAL COMPRESSION	RES	RESISTOR	TRH	TRUSS HEAD
CONN	CONNECTOR	HLEXT	HELICAL EXTENSION	RGD	RIGID	V	VOLTAGE
COV	COVER	HV	HIGH VOLTAGE	RLF	RELIEF	VAR	VARIABLE
CPLG	COUPLING	IC	INTEGRATED CIRCUIT	RTNR	RETAINER	W/	WITH
CRT	CATHODE RAY TUBE	ID	INSIDE DIAMETER	SCH	SOCKET HEAD	WSHR	WASHER
DEG	DEGREE	IDNT	IDENTIFICATION	SCOPE	OSCILLOSCOPE	XFMR	TRANSFORMER
DWR	DRAWER	IMPLR	IMPELLER	SCR	SCREW	XSTR	TRANSISTOR

CROSS INDEX—MFR. CODE NUMBER TO MANUFACTURER

Mfr. Code	Manufacturer	Address	City, State, Zip
000BK	STAUFFER SUPPLY	105 SE TAYLOR	PORTLAND, OR 97214
000CY	NORTHWEST FASTENER SALES, INC.	7923 SW CIRRIUS DRIVE	BEAVERTON, OREGON 97005
000FW	WESTERN SINTERING CO INC.	2620 STEVENS DRIVE	RICHLAND, WA 99352
00779	AMP, INC.	P O BOX 3608	HARRISBURG, PA 17105
08261	SPECTRA-STRIP CORP.	7100 LAMPSON AVE.	GARDEN GROVE, CA 92642
12327	FREEWAY CORPORATION	9301 ALLEN DRIVE	CLEVELAND, OH 44125
22526	BERG ELECTRONICS, INC.	YOUK EXPRESSWAY	NEW CUMBERLAND, PA 17070
22599	ESNA, DIV. OF AMERACE CORPORATION	16150 STAGG STREET	VAN NUYS, CA 91409
24931	SPECIALITY CONNECTOR CO., INC.	2620 ENDRESS PLACE	GREENWOOD, IN 46142
42838	NATIONAL RIVET AND MFG. CO.	1-21 EAST JEFFERSON ST.	WAUPUN, WI 53963
70278	ALLIED STEEL AND CONVEYORS, DIV. OF SPARTON CORP.	17333 HEALY	DETROIT, MI 48212
73743	FISCHER SPECIAL MFG. CO.	446 MORGAN ST.	CINCINNATI, OH 45206
74445	HOLO-KROME CO.	31 BROOK ST. WEST	HARTFORD, CT 06110
76854	OAK INDUSTRIES, INC., SWITCH DIV.	S. MAIN ST.	CRYSTAL LAKE, IL 60014
78189	ILLINOIS TOOL WORKS, INC. SHAKEPROOF DIVISION	ST. CHARLES ROAD	ELGIN, IL 60120
79136	WALDES, KOHINOOR, INC.	47-16 AUSTEL PLACE	LONG ISLAND CITY, NY 11101
80009	TEKTRONIX, INC.	P O BOX 500	BEAVERTON, OR 97077
83385	CENTRAL SCREW CO.	2530 CRESCENT DR.	BROADVIEW, IL 60153
86928	SEASTROM MFG. COMPANY, INC.	701 SONORA AVENUE	GLENDALE, CA 91201
87308	N. L. INDUSTRIES, INC., SOUTHERN SCREW DIV.	P. O. BOX 1360	STATESVILLE, NC 28677
97464	INDUSTRIAL RETAINING RING CO.	57 CORDIER ST.	IRVINGTON, NJ 07111

Replaceable Mechanical Parts—7A24 (SN B1030000 & UP)

Fig. & Index No.	Tektronix Part No.	Serial/Model No. Eff Dscont	Qty	1	2	3	4	5	Name & Description	Mfr Code	Mfr Part Number
1-1	131-1171-00		2						CONNECTOR, RCPT, :BNC, 50 OHM	24931	28JR231-1
-2	366-1059-00		2						PUSH BUTTON:GRAY	80009	366-1059-00
-3	366-1077-00		2						KNOB:GRAY	80009	366-1077-00
	213-0153-00		1						. SETSCREW:5-40 X 0.125, STL BK OXD, HEX	000CY	OBD
-4	366-1308-00		2						KNOB:RED	80009	366-1308-00
	213-0153-00		1						. SETSCREW:5-40 X 0.125, STL BK OXD, HEX	000CY	OBD
-5	366-1299-00		2						KNOB:GRAY	80009	366-1299-00
	213-0153-00		2						. SETSCREW:5-40 X 0.125, STL BK OXD, HEX	000CY	OBD
-6	366-1163-00		1						KNOB:LIGHT GRAY	80009	366-1163-00
	213-0153-00		1						. SETSCREW:5-40 X 0.125, STL BK OXD, HEX	000CY	OBD
-7	366-1165-00		1						KNOB:GRAY	80009	366-1165-00
	213-0153-00		1						. SETSCREW:5-40 X 0.125, STL BK OXD, HEX	000CY	OBD
-8	366-0215-02		2						KNOB:LEVER SWITCH	80009	366-0215-02
-9	366-1058-43		1						KNOB:LATCH	80009	366-1058-00
									(ATTACHING PARTS)		
-10	214-1095-00		1						PIN, SPG, SPLIT:0.094 OD X 0.187 INCH LONG	22599	52-022-094-0187
									- - - * - - -		
-11	105-0076-02		1						REL BAR, LATCH:PLUG-IN UNIT	80009	105-0076-02
-12	214-1280-00		1						SPRING, HLCPS:0.14 OD X 1.126"L, 0.16"DIA W	80009	214-1280-00
-13	214-1054-00		1						SPRING, FLAT:0.825 X 0.322, SST	80009	214-1054-00
-14	105-0075-00		1						BOLT, LATCH:7A & 7B SER PL-IN	80009	105-0075-00
-15	337-1064-04		2						SHIELD, ELEC:SIDE PLUG-IN UNITS	80009	337-1064-00
-16	348-0235-00		2						SHLD GSKT, ELEC:4.734 INCH LONG	80009	348-0235-00
-17	331-1592-01		1						PANEL, FRONT:	80009	331-1592-01
-18	384-1178-00		2						EXTENSION SHAFT:0.123 OD X 6.1 INCH LONG	80009	384-1178-00
-19	358-0216-00		1						BUSHING, PLASTIC:0.257 ID X 0.412 INCH OD	80009	358-0216-00
-20	-----		2						RESISTOR, VAR:(SEE R1487, R2487 EPL)		
									(ATTACHING PARTS)		
-21	210-0583-00		2						NUT, PLAIN, HEX.:0.25-32 X 0.312 INCH, BRS	73743	2X20317-402
-22	210-0223-00		2						TERMINAL, LUG:0.25 INCH DIA, SE	86928	A313-136
									- - - * - - -		
-23	131-1075-00		1						CONTACT, ELEC:GROUNDING, CU BE HEAT TRTD	80009	131-1075-00
-24	386-1447-54		1						SUBPANEL, FRONT:	80009	386-1447-54
									(ATTACHING PARTS)		
-25	213-0192-00		4						SCR, TPG, THD FOR:6-32 X 0.50 INCH, PNH STL	87308	OBD
									- - - * - - -		
-26	-----		1						SWITCH, SLIDE:(SEE S22A, B EPL)		
									(ATTACHING PARTS)		
-27	211-0030-00		2						SCREW, MACHINE:2-56 X 0.25"82 DEG, FLH STL	83385	OBD
-28	210-0405-00		2						NUT, PLAIN, HEX.:2-56 X 0.188 INCH, BRS	73743	2X12157-402
-29	210-0259-00	XB110000	1						TERMINAL, LUG:0.099"ID INT TOOTH, SE	80009	210-0259-00
									- - - * - - -		
-30	407-1172-00		2						BRACKET, CKT BD:BRASS	80009	407-1172-00
									(ATTACHING PARTS)		
-31	211-0008-00		4						SCREW, MACHINE:4-40 X 0.25 INCH, PNH STL	83385	OBD
-32	210-0586-00		2						NUT, PL, ASSEM WA:4-40 X 0.25, STL CD PL	83385	211-041800-00
-33	211-0007-00		2						SCREW, MACHINE:4-40 X 0.188 INCH, PNH STL	83385	OBD
									- - - * - - -		
-34	386-1402-00		1						PANEL, REAR:	80009	386-1402-00
									(ATTACHING PARTS)		
-35	213-0192-00		4						SCR, TPG, THD FOR:6-32 X 0.50 INCH, PNH STL	87308	OBD
-36	361-0326-00		1						SPACER, SLEEVE:0.18 ID X 0.25 OD X 0.10"L	80009	361-0326-00
									- - - * - - -		
-37	376-0039-00		2						ADPT, SHAFT, CPLG:0.128 AND 0.082"DIA SHAFT	80009	376-0039-00
	-----		-						. EACH COUPLING INCLUDES:		
	213-0075-00		2						. SETSCREW:4-40 X 0.094, STL BK OXD, HEX SKT	000BK	OBD
-38	376-0125-00		2						COUPLER, CAM SW:	80009	376-0125-00
									(ATTACHING PARTS)		
	213-0048-00		4						SETSCREW:4-40 X 0.125 INCH, HEX SOC STL	74445	OBD
									- - - * - - -		
-39	354-0251-00		4						RING, COUPLING:0.251 ID X 0.375 INCH OD, AL	80009	354-0251-00
-40	376-0124-00		2						ARM, SWITCH ACTR:DRIVER	80009	376-0124-00
									(ATTACHING PARTS)		
	213-0048-00		4						SETSCREW:4-40 X 0.125 INCH, HEX SOC STL	74445	OBD
									- - - * - - -		

Replaceable Mechanical Parts—7A24 (SN B1030000 & UP)

Fig. & Index No.	Tektronix Part No.	Serial/Model No. Eff	Dscont	Qty	1	2	3	4	5	Name & Description	Mfr Code	Mfr Part Number
1-41	384-1388-00			1						EXTENSION SHAFT:3.02 L X 0.078 OD,SST,PSVT	80009	384-1388-00
	672-0056-03	B103000	B109999	2						CKT BOARD KIT:READOUT/ATTENUATOR	80009	672-0056-03
	672-0056-04	B110000		2						CKT BOARD ASSY:READOUT/ATTENUATOR (ATTACHING PARTS)	80009	672-0056-04
-42	211-0008-00			4						SCREW,MACHINE:4-40 X 0.25 INCH,PNH STL	83385	OBD
	-----			-						. . . EACH CKT BOARD ASSY INCLUDES:		
-43	-----			1						. . . CKT BOARD ASSY:READOUT(SEE A2,A4 EPL) (ATTACHING PARTS)		
-44	211-0116-00			6						. . . SCR,ASSEM WSHR:4-40 X 0.312 INCH,PNH BRS	83385	OBD
	-----			-						. . . EACH CKT BOARD ASSY INCLUDES:		
-45	136-0350-00			1						. . . SOCKET,PLUG-IN:3 PIN,LOW PROFILE	80009	136-0350-00
-46	214-1136-00			1						. . . ACTUATOR,SL SW:DUAL DPST	80009	214-1136-00
-47	214-1190-02			1						. . . CPLG,SHAFT,RGD:0.125 OD TO 0.081 OD,AL	80009	214-1190-02
-48	131-0604-00			3						. . . CONTACT,ELEC:CKT BD SW,SPR,CU BE	80009	131-0604-00
-49	210-0779-00	B103000	B114839	7						. . . RIVET,TUBULAR:0.051 OD X 0.115 INCH LONG	42838	RA-29952715
	210-3082-00	B114840		7						. . . EYELET,METALLIC:0.047 OD X 0.133 L,BRASS	80009	210-3082-00
-50	131-1031-00			7						. . . CONTACT ASSY,EL:CAM SWITCH,TOP	80009	131-1031-00
-51	351-0180-00			1						. . . SLIDE,GUIDE:SWITCH ACTUATOR	80009	351-0180-00
-52	-----			1						. . . RESISTOR,VAR:(SEE R1423A,R2423A EPL)		
-53	-----			1						. . . RESISTOR,VAR:(SEE R1423B,R2423B EPL)		
-54	361-0515-00			2						. . . SPACER,SWITCH:PLASTIC	80009	361-0515-00
-55	131-0608-00	XB110000		10						. . . TERMINAL,PIN:0.365 L X 0.025 PH BRZ GOLD	22526	47357
-56	334-3448-00			1						. . . MARKER,IDENT:MARKED NOTICE	80009	334-3448-00
-57	407-1262-00			1						. . . BRACKET,ATTEN:BRASS CU-SN-ZN (ATTACHING PARTS)	80009	407-1262-00
-58	211-0097-00			2						. . . SCREW,MACHINE:4-40 X 0.312 INCH,PNH STL	83385	OBD
-59	210-0004-00			2						. . . WASHER,LOCK:#4 INTL,0.015THK,STL CD PL	78189	1204-00-00-0541C
	-----			-						. . . EACH CKT BOARD ASSY INCLUDES:		
-60	129-0299-00			2						. . . POST,ELEC-MECH:HEX,0.333 INCH LONG	80009	129-0299-00
-61	210-0004-00			1						. . . WASHER,LOCK:#4 INTL,0.015THK,STL CD PL	78189	1204-00-00-0541C
-62	210-1002-00			1						. . . WASHER,FLAT:0.125 ID X 0.25 INCH OD,BRS	12327	OBD
-63	-----			-						. . . CKT BOARD ASSY:ATTENUATOR(SEE A1,A3 EPL) (ATTACHING PARTS)		
-64	211-0116-00			2						. . . SCR,ASSEM WSHR:4-40 X 0.312 INCH,PNH BRS	83385	OBD
	-----			-						. . . EACH CKT BOARD ASSY INCLUDES:		
-65	131-1003-00			2						. . . CONN,RCPT,ELEC:CKT BD MT,3 PRONG	80009	131-1003-00
-66	136-0252-04			4						. . . SOCKET,PIN TERM:U/W 0.016-0.018 DIA PINS	22526	75060-007
-67	210-0779-00			8						. . . RIVET,TUBULAR:0.051 OD X 0.115 INCH LONG	42838	RA-29952715
-68	131-1030-00			8						. . . CONT ASSY,ELEC:CAM SWITCH,BOTTOM	80009	131-1030-00
-69	131-1031-00			8						. . . CONTACT ASSY,EL:CAM SWITCH,TOP	80009	131-1031-00
-70	344-0248-00			5						. . . CLIP,ATTENUATOR:	80009	344-0248-00
-71	214-1797-00			10						. . . PIN,ATTEN CLIP:	80009	214-1797-00
	263-1080-00			1						. . . SW CAM ACTR AS:VOLTS/DIV	80009	263-1080-00
-72	105-0243-00			1						. . . ACTUATOR,SWITCH:AC,DC (ATTACHING PARTS)	80009	105-0243-00
-73	213-0214-00			1						. . . SCREW,CAP SCH:2-56 X 0.375"HEX HD STL	70278	OBD
	-----			-						. . . EACH CKT BOARD ASSY INCLUDES:		
-74	210-0406-00			4						. . . NUT,PLAIN,HEX.:4-40 X 0.188 INCH,BRS	73743	2X12161-402
-75	214-1139-02			1						. . . SPRING,FLAT:GREEN COLORED	80009	214-1139-02
	214-1139-03			1						. . . SPRING,FLAT:RED COLORED	80009	214-1139-03
-76	214-1752-00			2						. . . ROLLER,DETENT:	80009	214-1752-00
-77	401-0180-00			1						. . . BEARING,CAM SW:FRONT & REAR (ATTACHING PARTS)	80009	401-0180-00
-78	354-0390-00			1						. . . RING,RETAINING:0.338 ID X 0.025" THK,STL	79136	5100-37MD
	-----			-						. . . EACH CKT BOARD ASSY INCLUDES:		
-79	105-0436-01			1						. . . ACTUATOR,CAM SW:DC,OFF	80009	105-0436-00
-80	384-0878-02			1						. . . SHAFT,CAM SW:	80009	384-0878-02
-81	210-0406-00			4						. . . NUT,PLAIN,HEX.:4-40 X 0.188 INCH,BRS	73743	2X12161-402
-82	401-0178-00			1						. . . BEARING,CAM SW:CENTER (ATTACHING PARTS)	80009	401-0178-00
-83	354-0443-00			1						. . . RING,RETAINING:0.328 FREE IDX 0.448 OD	97464	200-37

Replaceable Mechanical Parts—7A24 (SN B103000 & UP)

Fig. & Index No.	Tektronix Part No.	Serial/Model No. Eff Dscont	Qty	1 2 3 4 5	Name & Description	Mfr Code	Mfr Part Number
1-84	105-0437-01		1	. .	ACTUATOR,CAM SW:ATTENUATOR	80009	105-0437-01
-85	384-0880-02		1	. .	SHAFT,CAM SW:3.063 L X 0.188 OD INTMD	80009	384-0880-02
-86	210-0406-00		4	. .	NUT,PLAIN,HEX.:4-40 X 0.188 INCH,BRS	73743	2X12161-402
-87	214-1139-02		1	. .	SPRING,FLAT:GREEN COLORED	80009	214-1139-02
	214-1139-03		1	. .	SPRING,FLAT:RED COLORED	80009	214-1139-03
-88	214-1752-00		2	. .	ROLLER,DETENT:	80009	214-1752-00
-89	401-0180-00		1	. .	BEARING,CAM SW:FRONT & REAR	80009	401-0180-00
-90	129-0554-00		2		SPACER,POST:0.975" L W/4-40 THD,PLSTC (ATTACHING PARTS)	80009	129-0554-00
-91	211-0008-00		1		SCREW,MACHINE:4-40 X 0.25 INCH,PNH STL - - - * - - -	83385	OBD
-92	119-0418-00		2		CPLR,XMSN LINE:BALUN	80009	119-0418-00
	672-0691-00		1		CKT BOARD ASSY:AMPLIFIER (ATTACHING PARTS)	80009	672-0691-00
-93	211-0008-00		2		SCREW,MACHINE:4-40 X 0.25 INCH,PNH STL - - - * - - -	83385	OBD
	-----		-		CKT BOARD ASSY INCLUDES:		
-94	-----		1		CKT BOARD ASSY:BOAT ROCKER(SEE A6 EPL)		
-95	131-1261-00		4		CONTACT,ELEC:F-SHAPED	00779	1-380953-0
-96	-----		1		CKT BOARD ASSY:AMPLIFIER(SEE A5 EPL)		
-97	136-0252-04		126		SOCKET,PIN TERM:U/W 0.016-0.018 DIA PINS	22526	75060-007
-98	214-0579-00		1		TERM,TEST POINT:BRS CD PL	80009	214-0579-00
-99	131-0608-00		11		TERMINAL,PIN:0.365 L X 0.025 PH BRZ GOLD	22526	47357
-100	131-1003-00		6		CONN,RCPT,ELEC:CKT BD MT,3 PRONG	80009	131-1003-00
-101	-----		1		SW,RTRY,WIRED:(SEE S30A,B EPL) (ATTACHING PARTS)		
-102	210-0590-00		1		NUT,PLAIN,HEX.:0.375 X 0.438 INCH,STL	73743	2X28269-402
-103	210-0012-00		1		WASHER,LOCK:INTL,0.375 ID X 0.50" OD STL - - - * - - -	78189	1220-02-00-0541C
	-----		-		SWITCH ASSEMBLY INCLUDES:		
	260-1493-00		1		SWITCH,ROTARY:DISPLAY	76854	5-43681-411
-104	175-0826-00		FT		WIRE,ELECTRICAL:3 WIRE RIBBON	80009	175-0826-00
-105	175-0827-00		FT		CABLE,SP,ELEC:4,26 AWG,STRD,PVC JKT,RBN	08261	SS04267(1061)OC
-106	175-0828-00		FT		WIRE,ELECTRICAL:5 WIRE RIBBON	08261	SS-0526-710610C
-107	407-0912-00		1		BRACKET,CKT BD:BRASS CU-SN-ZN PL	80009	407-0912-00
-108	214-1061-00		1		SPRING,GROUND:FLAT	80009	214-1061-00
-109	220-0547-01		4		NUT,BLOCK:0.38 X 0.25 X 0.282"OA (ATTACHING PARTS)	000FW	OBD
-110	211-0105-00		4		SCREW,MACHINE:4-40 X 0.188"100 DEG,FLH STL - - - * - - -	83385	OBD
-111	426-0736-00		1		FR SECT,PLUG-IN:TOP	80009	426-0736-00
-112	426-0737-00		1		FR SECT,PLUG-IN:BOTTOM	80009	426-0737-00
	198-2151-01		1		WIRE SET,ELEC:	80009	198-2151-01
-113	175-0825-00		FT		WIRE,ELECTRICAL:2 WIRE RIBBON	80009	175-0825-00
-114	175-0826-00		FT		WIRE,ELECTRICAL:3 WIRE RIBBON	80009	175-0826-00
-115	175-0827-00		FT		CABLE,SP,ELEC:4,26 AWG,STRD,PVC JKT,RBN	08261	SS04267(1061)OC
-116	175-0828-00		FT		WIRE,ELECTRICAL:5 WIRE RIBBON	08261	SS-0526-710610C
-117	175-0829-00		FT		WIRE,ELECTRICAL:6 WIRE RIBBON	08261	SS-0626-710610C
-118	175-0831-00		FT		WIRE,ELECTRICAL:8 WIRE RIBBON	08261	SS-0826-710610C
-119	175-0832-00		FT		WIRE,ELECTRICAL:9 WIRE RIBBON	08261	SS-0926(1061)OC
-120	131-0707-00		29		CONNECTOR,TERM.:22-26 AWG,BRS& CU BE GOLD	22526	47439
-121	352-0169-00	B103000 B109999	1		HLDR,TERM CONN:2 WIRE BLACK	80009	352-0169-00
	352-0169-09	B110000	1		CONN BODY,PL,EL:2 WIRE WHITE	80009	352-0169-09
-122	352-0161-00		1		HLDR,TERM CONN:3 WIRE BLACK	80009	352-0161-00
-123	352-0162-00		2		HLDR,TERM CONN:4 WIRE BLACK	80009	352-0162-00
-124	352-0166-00	B103000 B109999	2		CONN BODY,PL,EL:8 WIRE BLACK	80009	352-0166-00
	352-0166-09	B110000	2		HLDR,TERM CONN:8 WIRE WHITE	80009	352-0166-09

Fig. & Index No.	Tektronix Part No.	Serial/Model No. Eff	Dscont	Qty	1	2	3	4	5	Name & Description	Mfr Code	Mfr Part Number
	070-2391-00			1						MANUAL TECH:INSTRUCTION	80009	070-2391-00

@

7A24 DUAL TRACE AMPLIFIER (S/N B103000 & up)

MANUAL CHANGE INFORMATION

At Tektronix, we continually strive to keep up with latest electronic developments by adding circuit and component improvements to our instruments as soon as they are developed and tested.

Sometimes, due to printing and shipping requirements, we can't get these changes immediately into printed manuals. Hence, your manual may contain new change information on following pages.

A single change may affect several sections. Since the change information sheets are carried in the manual until all changes are permanently entered, some duplication may occur. If no such change pages appear following this page, your manual is correct as printed.

SERVICE NOTE

Because of the universal parts procurement problem, some electrical parts in your instrument may be different from those described in the Replaceable Electrical Parts List. The parts used will in no way alter or compromise the performance or reliability of this instrument. They are installed when necessary to ensure prompt delivery to the customer. Order replacement parts from the Replaceable Electrical Parts List.

CALIBRATION TEST EQUIPMENT REPLACEMENT

Calibration Test Equipment Chart

This chart compares TM 500 product performance to that of older Tektronix equipment. Only those characteristics where significant specification differences occur, are listed. In some cases the new instrument may not be a total functional replacement. Additional support instrumentation may be needed or a change in calibration procedure may be necessary.

Comparison of Main Characteristics

DM 501 replaces 7D13		
PG 501 replaces 107	PG 501 - Risetime less than 3.5 ns into 50 Ω .	107 - Risetime less than 3.0 ns into 50 Ω .
108	PG 501 - 5 V output pulse; 3.5 ns Risetime.	108 - 10 V output pulse; 1 ns Risetime.
111	PG 501 - Risetime less than 3.5 ns; 8 ns Pretrigger pulse delay.	111 - Risetime 0.5 ns; 30 to 250 ns Pretrigger Pulse delay.
114	PG 501 - ± 5 V output.	114 - ± 10 V output. Short proof output.
115	PG 501 - Does not have Paired, Burst, Gated, or Delayed pulse mode; ± 5 V dc Offset. Has ± 5 V output.	115 - Paired, Burst, Gated, and Delayed pulse mode; ± 10 V output. Short-proof output.
PG 502 replaces 107		
108	PG 502 - 5 V output	108 - 10 V output.
111	PG 502 - Risetime less than 1 ns; 10 ns Pretrigger pulse delay.	111 - Risetime 0.5 ns; 30 to 250 ns Pretrigger pulse delay.
114	PG 502 - ± 5 V output	114 - ± 10 V output. Short proof output.
115	PG 502 - Does not have Paired, Burst, Gated, Delayed & Undelayed pulse mode; Has ± 5 V output.	115 - Paired, Burst, Gated, Delayed & Undelayed pulse mode; ± 10 V output. Short-proof output.
2101	PG 502 - Does not have Paired or Delayed pulse. Has ± 5 V output.	2101 - Paired and Delayed pulse; 10 V output.
PG 506 replaces 106	PG 506 - Positive-going trigger output signal at least 1 V; High Amplitude output, 60 V.	106 - Positive and Negative-going trigger output signal, 50 ns and 1 V; High Amplitude output, 100 V.
067-0502-01	PG 506 - Does not have chopped feature.	0502-01 - Comparator output can be alternately chopped to a reference voltage.
SG 503 replaces 190, 190A, 190B, 191, 067-0532-01	SG 503 - Amplitude range 5 mV to 5.5 V p-p. SG 503 - Frequency range 250 kHz to 250 MHz. SG 503 - Frequency range 250 kHz to 250 MHz.	190B - Amplitude range 40 mV to 10 V p-p. 191 - Frequency range 350 kHz to 100 MHz. 0532-01 - Frequency range 65 MHz to 500 MHz.
TG 501 replaces 180, 180A	TG 501 - Marker outputs, 5 sec to 1 ns. Sinewave available at 5, 2, and 1 ns. Trigger output - slaved to marker output from 5 sec through 100 ns. One time-mark can be generated at a time.	180A - Marker outputs, 5 sec to 1 μ s. Sinewave available at 20, 10, and 2 ns. Trigger pulses 1, 10, 100 Hz; 1, 10, and 100 kHz. Multiple time-marks can be generated simultaneously.
181	TG 501 - Marker outputs, 5 sec to 1 ns. Sinewave available at 5, 2, and 1 ns.	181 - Marker outputs, 1, 10, 100, 1000, and 10,000 μ s, plus 10 ns sinewave.
184	TG 501 - Marker outputs, 5 sec to 1 ns. Sinewave available at 5, 2, and 1 ns. Trigger output - slaved to marker output from 5 sec through 100 ns. One time-mark can be generated at a time.	184 - Marker outputs, 5 sec to 2 ns. Sinewave available at 50, 20, 10, 5, and 2 ns. Separate trigger pulses of 1 and .1 sec; 10, 1, and .1 ms; 10 and 1 μ s. Marker amplifier provides positive or negative time marks of 25 V min. Marker intervals of 1 and .1 sec; 10, 1, and .1 ms; 10 and 1 μ s.
2901	TG 501 - Marker outputs, 5 sec to 1 ns. Sinewave available at 5, 2, and 1 ns. Trigger output - slaved to marker output from 5 sec through 100 ns. One time-mark can be generated at a time.	2901 - Marker outputs, 5 sec to 0.1 μ s. Sinewave available to 50, 10, and 5 ns. Separate trigger pulses, from 5 sec to 0.1 μ s. Multiple time-marks can be generated simultaneously.

NOTE: All TM 500 generator outputs are short-proof. All TM 500 plug-in instruments require TM 500-Series Power Module.