

YAMAHA

MSX

MUSIC COMPUTER

MSM

OWNER'S MANUAL

NIPPON GAKKI CO., LTD.
PRINTED IN JAPAN

FCC INFORMATION (for United States Customers Only)

While the following statement is provided to comply with FCC regulations in the United States, the corrective measures listed are applicable worldwide.

“WARNING—This equipment has been certified to comply with the limits for a Class B computing device, pursuant to Subpart J of Part 15 of FCC Rules. Only peripherals (computer input/output devices, terminals, printers, etc.) certified to comply with the Class B limits may be attached to this computer. Operation with non-certified peripherals is likely to result in interference to radio and TV reception.”

The CX5M and its accessories have been tested and certified to be in compliance with the limits established for this class of equipment pursuant to FCC Rules Part 15, Subpart J. These limits were established to provide a reasonable measure of protection against such interference; however, this does not guarantee that interference will not occur. If the CX5M equipment is suspected of causing interference with other electronic equipment, verification can be made by turning off the CX5M. If the interference continues, then the CX5M is not the source of the interference. If the CX5M does appear to be the source of the interference, you should try to correct the situation by one or more of the following measures.

- Relocate either the CX5M and its accessories or the electronic equipment that is being affected by the interference.
- Utilize power outlets for the CX5M and the equipment being affected that are on different branch circuits (utilizing different circuit breakers or fuses), or install AC line filters.
- In the case of radio interference, relocate the antenna. If the antenna cable is 300 ohm ribbon lead, have it changed to 75 ohm coaxial cable (utilizing the necessary transformer/adaptors at either end, as required to match the cable).

If these corrective measures do not produce satisfactory results, please contact a Yamaha Retailer authorized to sell this product for suggestions and/or corrective measures. If you cannot locate a Yamaha Retailer authorized to sell this product in your general area, please contact the Yamaha International Corporation, MMC Service Division, 6600 Orangethorpe Avenue, Buena Park, CA 90620, USA.

If for any reason you should need additional information relating to radio and TV interference, you may find a booklet prepared by the Federal Communications Commission helpful: “How to Identify and Resolve Radio/TV Interference Problems”. This booklet, Stock #004-000-00345-4, is available from the U.S. Government Printing Office, Washington D.C. 20402.



MSX is a trademark of Microsoft Corporation

CONTENTS

INTRODUCTION

FEATURES OF THE CX5M MUSIC COMPUTER	2
CX5M ACCORDING TO AREA	2
PRECAUTIONS	3
BASIC SYSTEM CONFIGURATION	4
CONNECTING	
For CX5MU, C	6
For CX5MF	8
Except CX5MU, C, F	9

OPERATION

OPERATING THE CX5M	12
THE CX5M KEYBOARD	13
USING A ROM CARTRIDGE, REAR SLOT	16
SAMPLE PROGRAMS	17
CASSETTE SAVE/LOAD OPERATIONS	18-20

FM SOUND SYNTHESIZER UNIT

FM SOUND SYNTHESIZER UNIT CONNECTIONS	22
THE "CALL MUSIC" COMMAND	23
DISPLAY SCREEN	24
SELECTING THE 46 PRESET VOICES	26
KEYBOARD SPLIT	27
ADDING RHYTHM	28
ADDING AUTO BASS CHORD	29
SEVENTH CHORDS	30
RECORDING KEYBOARD PLAY	30
CASSETTE SAVE/LOAD OPERATION	31
MODIFYING EFFECT PARAMETERS (LFO, Portamento, etc.)	32
MIDI COMPATIBILITY	34
FM VOICE LIST	34

ADDITIONAL INFORMATION

KEYBOARD MODES	36
ASCII CODE TABLE	38
CONTROL CODE TABLE	39
BASIC COMMAND LIST	40
ERROR MESSAGES	44
TROUBLESHOOTING	45
SPECIFICATIONS	46-48
CX5M SOFTWARE AND PERIPHERAL OPTIONS	49

INTRODUCTION

FEATURES OF THE CX5M MUSIC COMPUTER

- The CX5M is a highly versatile personal computer which conforms to the MSX standard operating system. The unique feature of the CX5M is its built-in FM Sound Synthesizer unit.
- The FM Sound Synthesizer unit uses the same type of FM tone generation system as the Yamaha DX synthesizers, producing exceptionally realistic, high-quality sound.
- The FM Sound Synthesizer is a 8 note polyphonic synthesizer, capable of producing 8 notes simultaneously.
- The 46 pre-programmed preset voices can be extensively modified with a number of LFO and effects options during keyboard play.
- With the Yamaha Music Keyboard (either YK-01 or YK-10), the CX5M becomes a live performance keyboard synthesizer. A programmable poly/mono keyboard split function allows you to play two voices simultaneously in real time.
- Auto rhythm and auto bass chord accompaniment can be added to your keyboard performances.
- A built-in recording function permits recording and playback of keyboard play, letting you accompany the electronically recorded passage.
- The CX5M's FM Sound Synthesizer unit is equipped with a MIDI interface which allows it, and therefore the CX5M, to communicate with the Yamaha DX synthesizers, RX Rhythm Programmers and all MIDI equipped instruments and devices.
- In addition to the standard MSX cartridge slot, the CX5M has a rear slot, for additional flexibility and future expendability.

CX5M ACCORDING TO AREA

There are different models of the CX5M Music Computer, according to area. This manual refers to the computer as only the CX5M, referring to all models. Where reference to a particular model is called for, the specific model number pertaining to the area in question will be used. The different model numbers, and the areas to which they pertain, are as follows: The model of your CX5M is specified on the back panel label. Consult the part of this manual for your particular model.

CX5MU — U.S.A., Taiwan, Central and South America

CX5MC — Canada

CX5MG — West Germany, Some of European countries

CX5MS — Scandinavian countries

CX5ME — United Kingdom

CX5MF — France

CX5MA — Australia and New Zealand

CX5MH — Hong Kong, South Africa

CX5MB — Italy, Spain, Israel, Arab countries, etc.

CX5MZ — Singapore, Indonesia, etc.

CX5M□ — Other countries

NOTE:
The model differentiation is based on differences in television standards and power sources by countries or areas.

PRECAUTIONS

Please observe the following precautions regarding the CX5M:

- a) Turn off power and disconnect the power cord if you feel something is wrong with the CX5M.
- b) Handle the CX5M with care. Avoid dropping or knocking it.
- c) Don't attempt to disassemble the CX5M. Internal components may be damaged by doing so, and there are no user-serviceable parts inside.
- d) Keep the CX5M dry.
- e) Handle all connection cords carefully.
- f) Disconnect the power during an electrical storm.
- g) Keep the CX5M in a cool, dry, clean environment. Dust, heat, or excess humidity can cause corrosion or deterioration of connectors, leading to premature malfunction.
- h) Clean the CX5M only with a moist or dry cloth. Do not use chemical cleaners or solvents.
- i) Keep the air vents unobstructed for proper cooling.
Make sure power switch is turned off when making this connection.

NOTE:

With computers, unlike some typewriters, the upper case letter O is not the same as the number Zero (0). Also, the lower case letter el (l) is not the same as the number 1. Be sure to type the correct characters.

BASIC SYSTEM CONFIGURATION

Video monitor, preferably color, or color television set

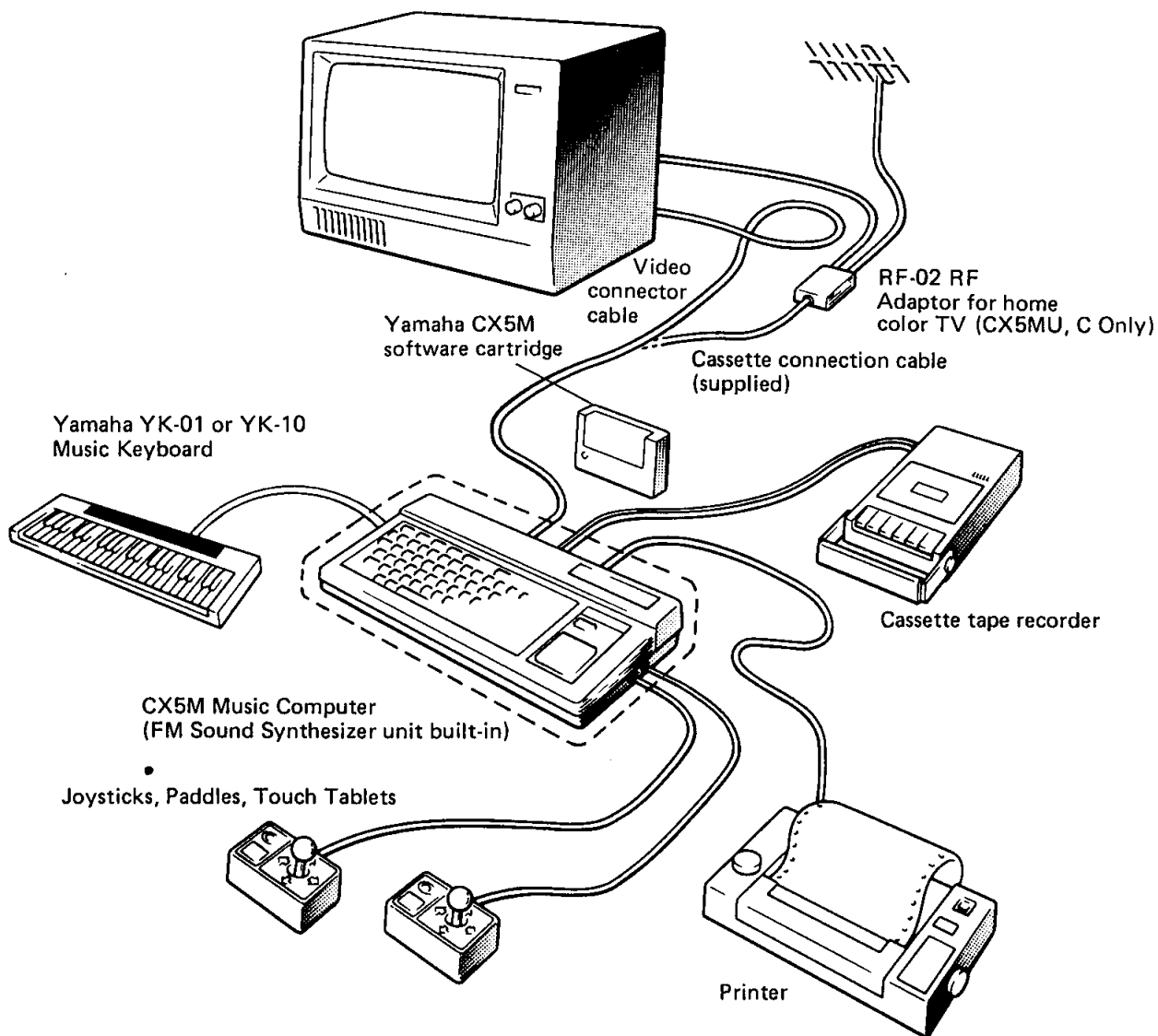

Connecting Cable

Connect peripherals using the following cables.

- Cassette connection cable (included)
- RF cable (included except for CX5MU, C, F)
- RGB cable (included only with CX5MF)
- Audio and video connector cable
- RF converter with cable (for CX5MU, C)
- Printer cable
- MIDI cable

Peripherals

The following peripherals may be connected.

- TV (Video Monitor or Home Color TV)
- Date Recorder (Cassette Tape Recorder)
- Music keyboard (YK-01 or YK-10)
- Digital keyboard with MIDI connector (DX7, DX9 etc.)
- Joysticks
- Printer

NOTE:

See page 6 ~ 9 for diagram of connections.

CONNECTING (For CX5MU,C)

Rear slot

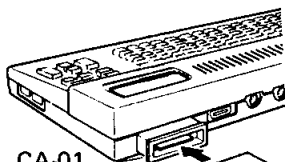

CA-01
Single cartridge
adaptor Program cartridge

ROM cartridge

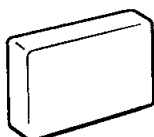

Joy sticks

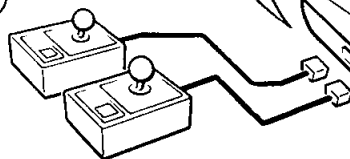

Printer

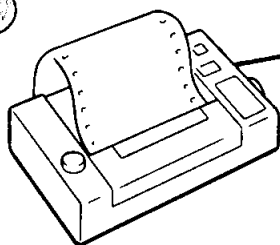

Cassette tape recorder

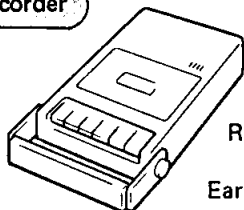

Mic
Remote
Earphone

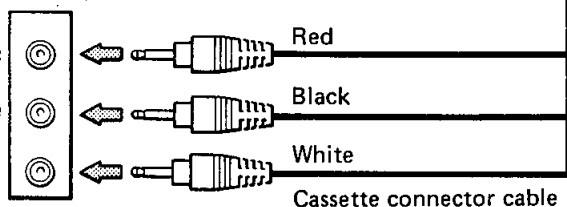

Red
Black
White
Cassette connector cable

Red
White

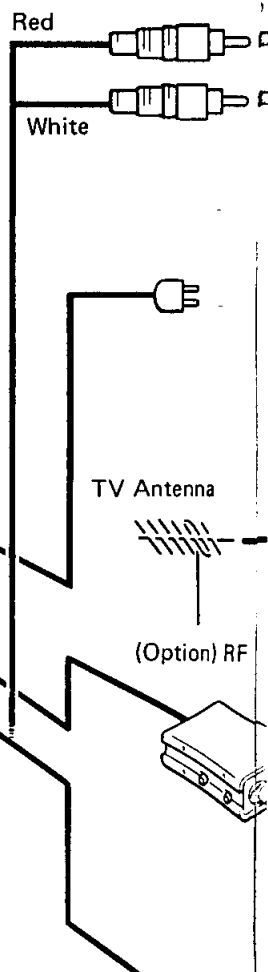

TV Antenna

(Option) RF

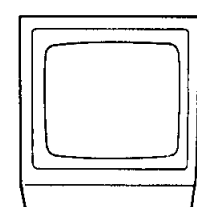

Video monitor

Video monitor connections

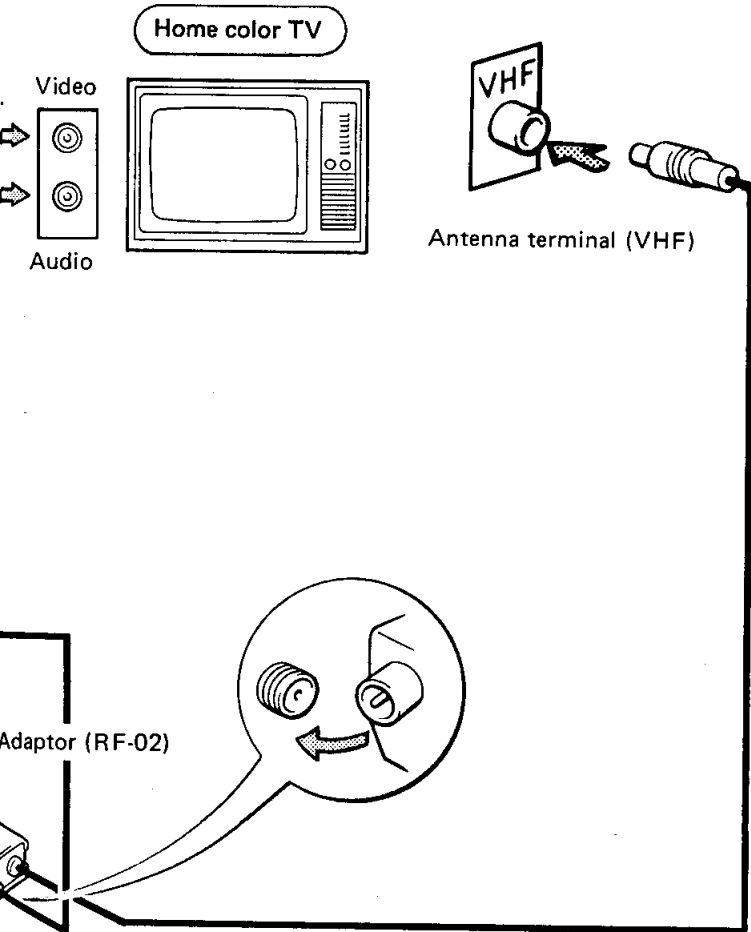

(Option) Audio & video connector-cable (VC-02)

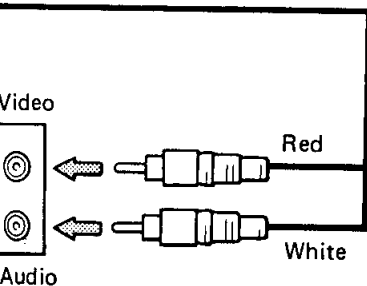

Connecting Cable

Connect peripherals (printer, joysticks, RF converters, cassette tape recorders, video display etc.) to the CX5M using the following cables.

Audio and video connector cable	VC-02
RF converter with cable	RF-02
Cassette connection cable	M155116
Printer cable	CB-X1
MIDI cable	MD-X1
Joysticks	YJS-01

Please be sure you use the ones indicated, or equivalent cables and peripherals. If you substitute, be sure to use cables with ferrite cores, to eliminate radio frequency interference.

RF Adaptor for Home Color TV RF-02

If you are using a video monitor or a TV with a video input, connect the CX5M to the video input using the VC-02 video cable.

If you are using a home TV, you must connect the CX5M using the RF-02 RF adaptor. Switch the TV to either channel 3 or 4, whichever is not being used. Switch the RF-02 to the same channel as the TV.

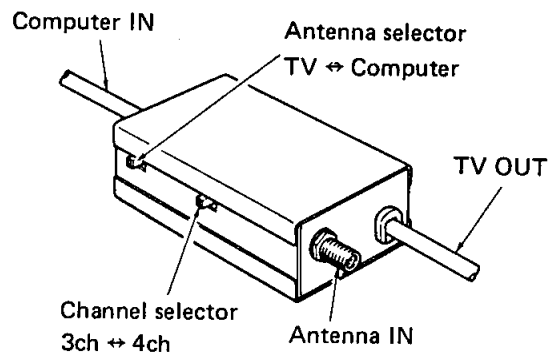

CONNECTING (For CX5MF)

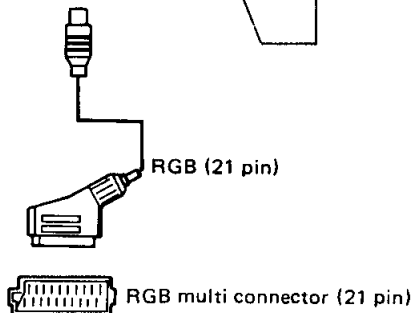
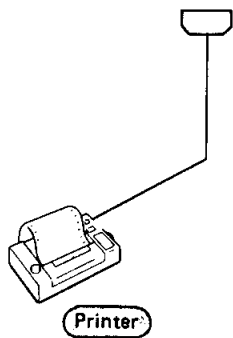
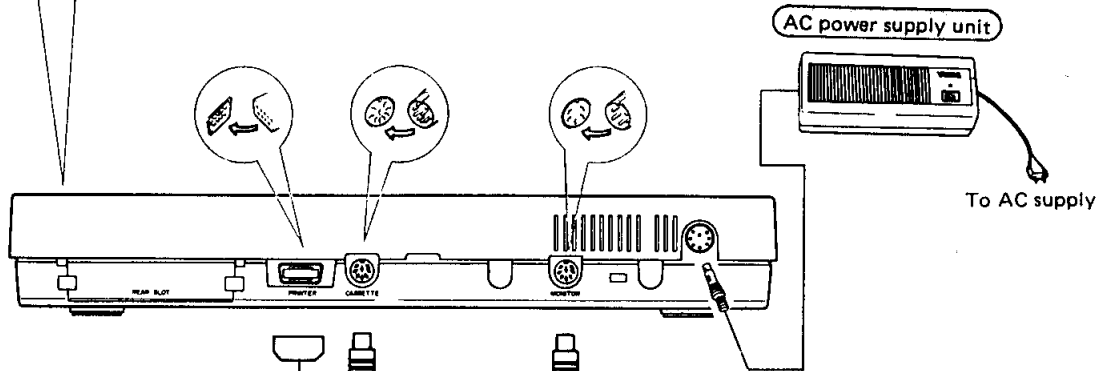
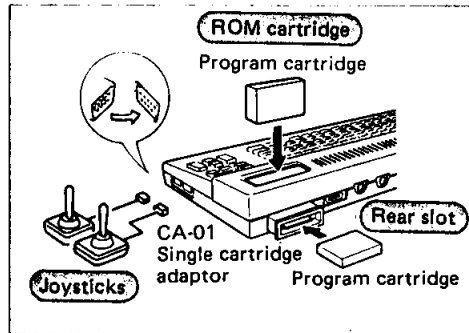

The CX5MF must be used with an RGB video monitor or TV. Connect the CX5MF monitor output to the RGB input using an RGB cable.

Cassette tape recorder

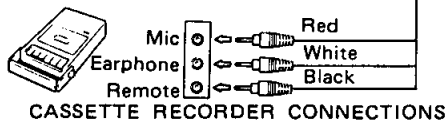

CONNECTING (Except CX5MU, C, F)

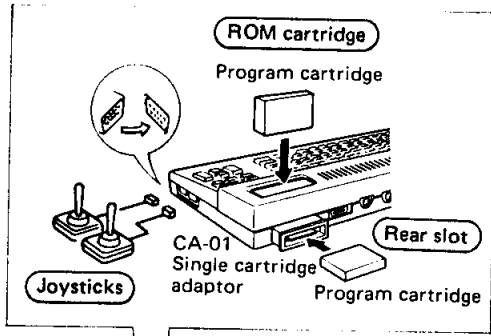

When the L/R audio outputs on the side of the CX5M are used for the audio output signal, we recommend do not connect the audio output on the rear of the CX5M to the video monitor's audio input.

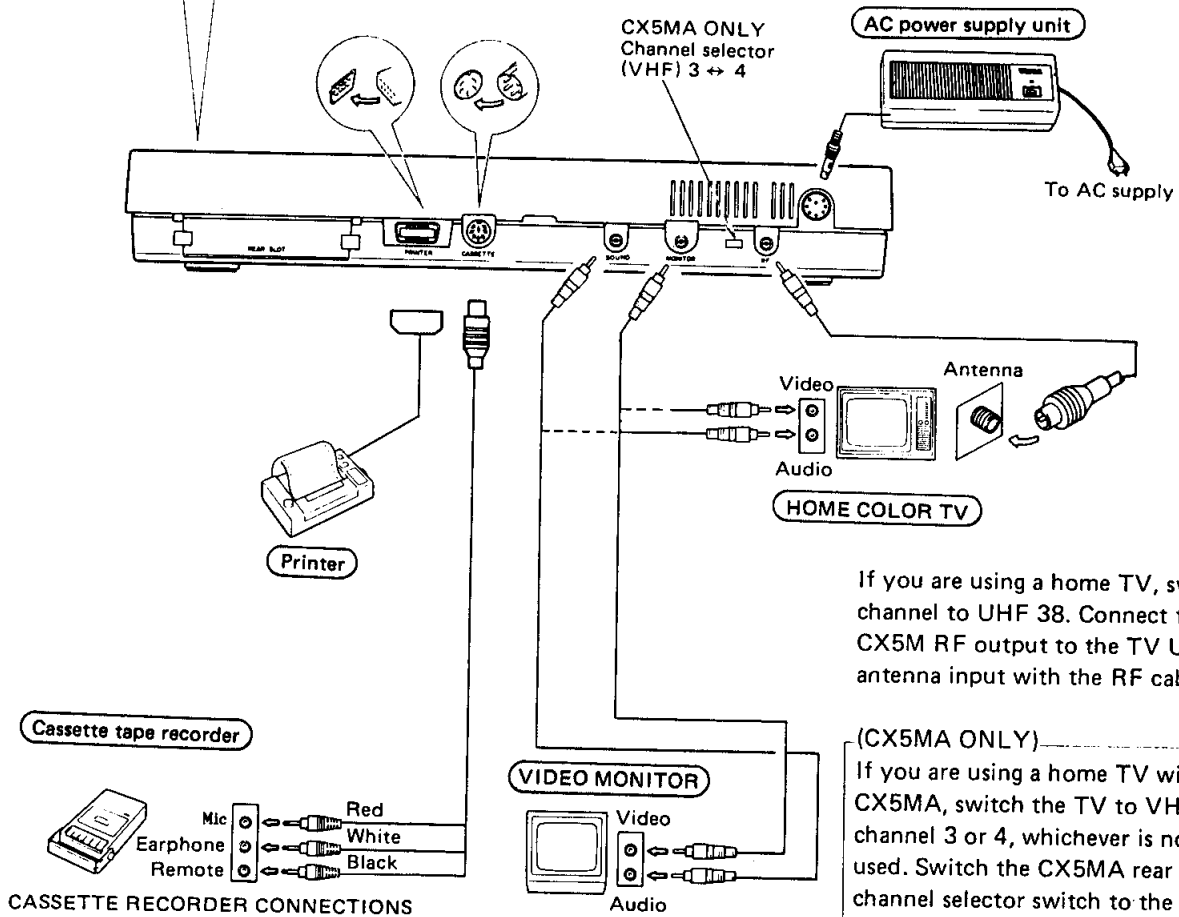

If you are using a home TV, switch the channel to UHF 38. Connect the CX5M RF output to the TV UHF antenna input with the RF cable.

(CX5MA ONLY)
If you are using a home TV with the CX5MA, switch the TV to VHF channel 3 or 4, whichever is not being used. Switch the CX5MA rear panel channel selector to the same channel as the TV. Connect the CX5MA RF output the RF cable.



OPERATION

OPERATING THE CX5M

Check Connections

1. Check Connections

Make sure all connections are properly made, according to the connections diagrams in this manual. If any connections are improperly made, make sure you turn power off to all components before remedying the situation.

2. Turn on the power switch of the CX5M. When nothing is plugged into the upper or rear ROM cartridge slots, the computer will enter the MSX Basic mode, and the screen display will be as follows:

CAUTION:

The external power supply has a power On/Off switch. Make sure this is turned off before connecting it to the CX5M. After connections are made, first turn on power to the external power supply unit. Then, turn on power to the computer with the CX5M power On/Off switch. When power is turned off prior to inserting and removing cartridges in the upper or rear slots, use the CX5M power switch.

Check

- (1) Check to see that the power cord and switches of the video monitor (or TV) are correctly set, and is the monitor (TV) connected to the power mains?
- (2) Are the brightness and contrast of the screen set correctly?
- (3) Does the fine turning control knob of the TV require adjustment?

```
MSX BASIC version 1.0
Copyright 1983 by Microsoft
28815 Bytes free
OK
■
```

```
color auto goto list run
```

3. When the screen display does not correspond to that shown here, turn off the main power switch, wait for at least 30 seconds, and turn on the power switch once again. If the screen display is still incorrect, check the following:

THE CX5M KEYBOARD

Using the CX5M Keyboard

The CX5M keyboard conforms to ASCII standards. The keyboard will function in the normal mode (as an alphanumeric keyboard) and in a special graphics mode as well (special graphics characters are accessed by specially designated keys on the keyboard). A repeat function is built in, so that if a key is pressed and held for longer than one second, the same character will be displayed repeatedly until the key is released. Many of the keys will serve different functions according to the particular CX5M application program in use (MSX Basic, Yamaha FM Music Composer software cartridge, etc.). These multiple functions are explained in the corresponding operating manuals for the individual software packages.

Dead Key

Pressing the dead key, or the shift and code keys with the dead key, will cause accent marks to be added to the letters a, e, i, o, and u when those letter keys are pressed. This will not operate with other keys.

Condition	Function
Normal	Accent grave (`)
Shift	Accent egru (´)
Graph	Accent grave (`)
Graph + shift	Accent egru (´)
Code	Accent circumflex (^)
Code + shift	Umlaut (¨)

Note:

For a list of characters produced using the SHIFT and CODE keys, See P.P. 36-37.

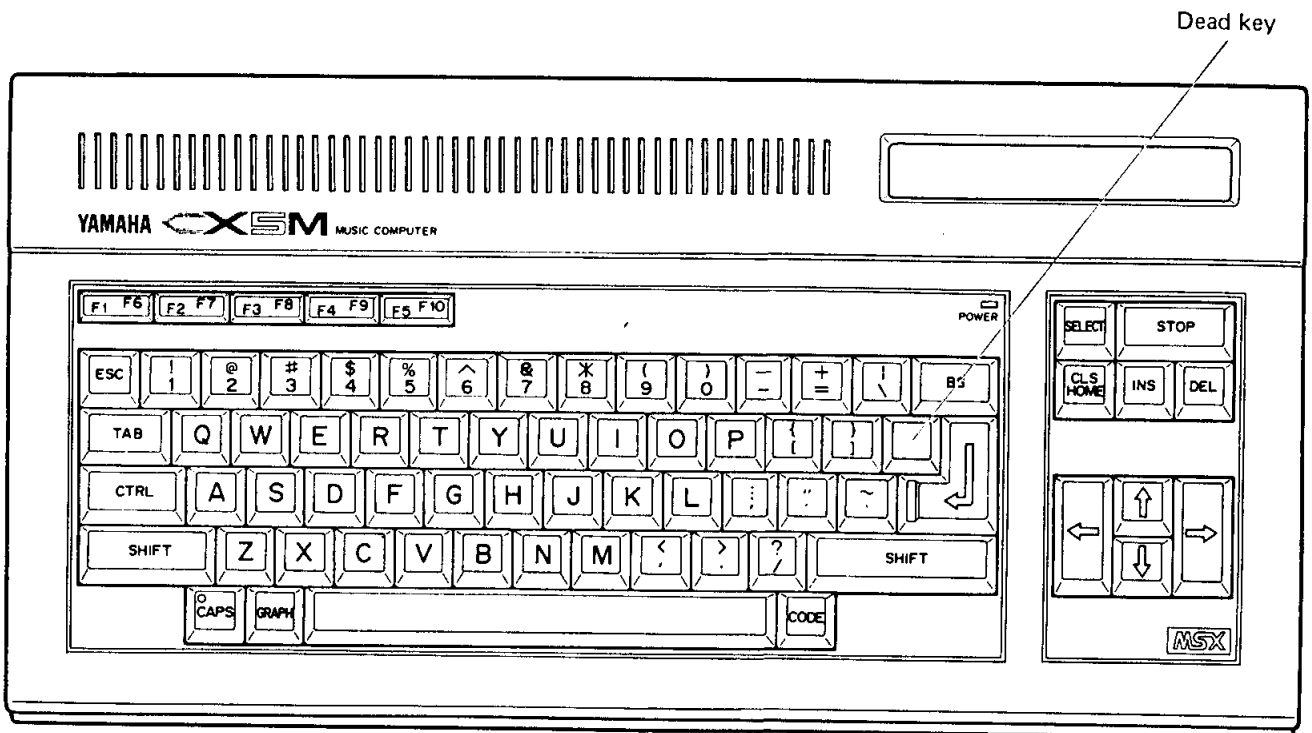

(Model CX5MU)

Function keys

Function keys allow you to execute certain designated functions by simply pressing the designated key, rather than entering the full command from the keyboard. When using the CX5M as an entry level computer for programming, these keys access the various commands shown in the diagram. These Basic commands are also displayed on the bottom of the monitor screen. When using Yamaha music software cartridge (FM Music Composer, Voicing Program, etc.) these keys will execute particular commands within the framework of the particular software program in use.

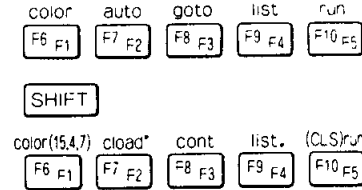

ESC key (Escape)

Performs the Escape function while programming in MSX Basic. Does not perform a direct function outside of MSX Basic.

TAB key

This key will move the cursor 8 spaces to the right each time it is pressed.

CTRL key (Control)

In combination with other keys, can be used to execute special functions. (See Control Code Table)

SHIFT key

This key functions as a standard typewriter shift key. For any key which has two symbols marked on it the shift function will access the upper case characters. The SHIFT key has no effect when the GRAPH key is being held down.

CAPS key

This key functions similarly to a "shift lock" key on a standard typewriter, except that punctuation marks and numeric keys are not shifted. An indicator lights when the key is pressed, for visual confirmation of this mode. Pressing the key again cancels the mode, and the indicator goes out.

Function keys

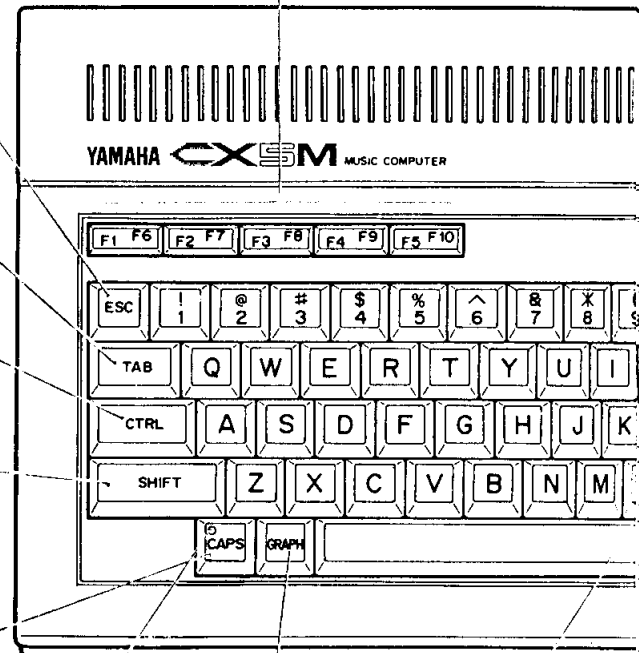

CAPS indicator

Space key

Graph Key

The keyboard layout diagrams included in this manual show which keys on the keyboard are assigned special graphics characters as well as alphanumeric characters. These characters are accessed (displayed on the screen) when the corresponding key is pressed simultaneously with the Graph key.

BS key (Backspace)

When the BS key is pressed, the character to the immediate left of the cursor is erased, and the cursor will move to the left by an amount corresponding to the number of characters erased.

Power indicator

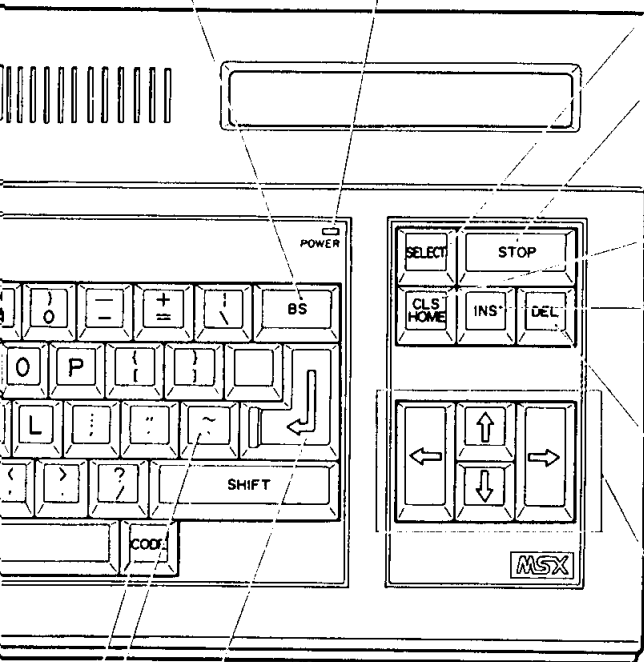

SELECT key

This key has no direct function when the CX5M is used strictly as a Basic computer. It does serve important functions when the CX5M is used with a Yamaha software cartridge of when the "call music" command is invoked. The function of the SELECT key within each particular software package will be explained in the operating manual of that software package.

STOP key

Pressing the STOP key together with the CTRL key will stop a program while it is running.

CLS HOME key

Pressing the CLS HOME key while holding down the SHIFT key will clear the screen display, and return the cursor to the upper left hand corner of the screen (home position).

INS key (Insert)

When editing text displayed on the screen, the INS key allows you to insert characters at any point on the screen. When the INS key is pressed, the cursor will shrink to half its normal size, allowing characters, numbers and symbols to be inserted between the cursor and the character displayed to its left. Pressing the RETURN key, space bar, or INS key again cancels the insert mode and restores the cursor to its original size.

DEL key (Delete)

When the DEL key is pressed, the character on the display screen where the cursor is positioned is erased, and the entire line to the right of that character moves left by an amount corresponding to the number of characters erased.

CURSOR Keys

These keys will move the cursor one character space or one line in the direction indicated by the arrow on the key. Pressing a cursor key repeatedly will move the cursor in the direction indicated by an amount equivalent to the number of times the key is pressed. The cursor keys have other special functions when the CX5M is used with a Yamaha software cartridge.

RETURN key

Pressing this key "enters" a command statement and returns the cursor to the beginning of a new line.

NOTE:

Only the CX5MU, C
All other models have this key.



Code key

Pressing the code key together with the appropriate key produces a second set of characters such as Greek, German, French, etc.

USING A ROM CARTRIDGE, REAR SLOT

Using a ROM Cartridge

Insert the cartridge as illustrated.

CAUTION:

Be sure that the power switch of the main unit is turned off before inserting a ROM cartridge.

Remember that turning off the power will erase all programs contained in the computer memory, so if you have been writing a program you may wish to save the data on a cassette tape first. (see page 18)

1. You will find the ROM cartridge slot on the upper panel of the computer. Following the accompanying illustration, insert the appropriate cartridge into the slot, with the cartridge aligned as shown.
2. Normally, the cartridge slot is covered by a protective flap. Simply push the cartridge through the flap and press it firmly in place. Then turn on the CX5M power switch.
3. For directions concerning the screen display and the operation procedures, consult the instruction manual supplied with the ROM cartridge.

NOTE:

When shutting off the computer/sound system, turn off power to the CX5M first. NEVER remove a ROM cartridge from the upper slot or from the rear slot while the power is on. Make sure power is off before inserting or removing ROM cartridges; you might "get away" with this once or more, but it is possible that you might damage the CX5M or the cartridge.

Using the Rear Slot

By attaching the optional Single Cartridge Adaptor (CA-01), you may use the rear slot as a ROM cartridge slot.

CAUTION:

Please insert the Single Cartridge Adaptor and the ROM cartridge with the power turned OFF.

1. The rear slot is on the back of the CX5M. Remove the rear slot cover. Carefully and firmly insert the Single Cartridge Adaptor, making sure that the label of model name side is up.
2. Turn the power on.

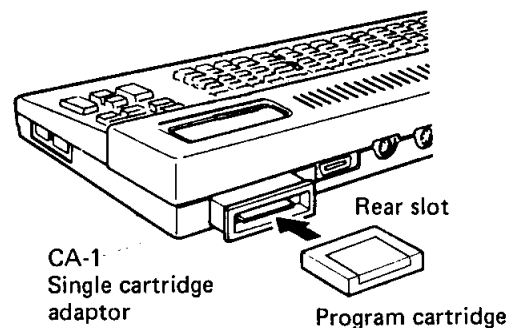
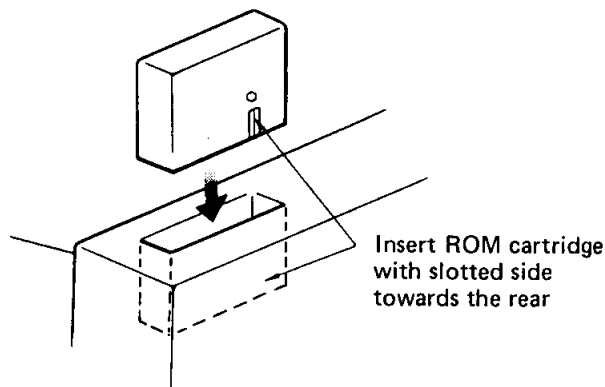

SAMPLE PROGRAMS

The following programs are simple Basic programs that demonstrate the structure and flow of a Basic computer program. In order to become familiar with the CX5M and the keyboard, try entering the programs and running them. When in the MSX Basic mode, the screen should appear as follows:

Type in the program just as it appears here, then type the command "run", followed by RETURN. If the program has been correctly entered, it should run properly. If not, type LIST and RETURN to list the program on the screen. Find your error and correct it, using the cursor keys, INS key, DEL key, etc. to edit on the screen. Then try to run it again.

```
10 SCREEN 2,3,0:CLS
20 COLOR 5,15,7
30 FOR I=0 TO 15
40 C=I:IF C=0 THEN C=5
50 X=INT(RND(-TIME)*240):IF X<40 OR X>200 THEN 50
60 Y=INT(RND(1)*180):IF Y<40 OR Y>180 THEN 60
70 R=INT(RND(1)*50):IF R<30 OR R>70 THEN 70
80 A=RND(1)+.5:IF A<.2 OR A>1.8 THEN 80
90 CIRCLE(X,Y),R,C,,,A
100 NEXT I
110 GOTO 110
```

This program will draw circles of many different shapes onto the screen in 15 colors. If line 80 and the final A of line 90 are deleted, the program will draw circles of many different sizes.

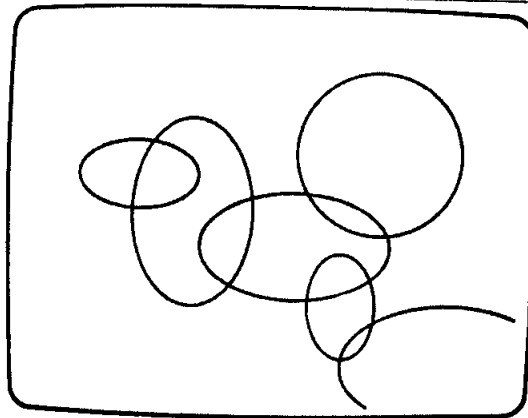

```
10 CLS:SCREEN 2,3,0
40 LINE(0,0)-(63,192),2,BF
50 LINE(64,0)-(127,192),4,BF
60 LINE(128,0)-(191,192),8,BF
70 LINE(192,0)-(255,192),15,BF
80 GOTO 80
```

If you want to save this program for later use or study, please refer to the section on cassette save/load operations for instructions on how to save it on cassette tape. If you enter another program, it will write over the first one, so the first program must be cleared from memory. This is done by entering the command "new" (do not type the quotation marks) and pressing RETURN. The new program will display four color bars (green, dark blue, red, white) onto the screen. Changing the color numbers (2, 4, 8, 15) of lines 20 through 50 will enable color bars of the designated color to be drawn.

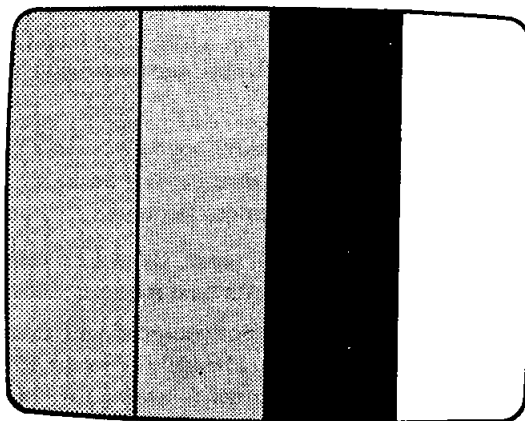

This program will produce sound.

```
10 A$="T100L804G805D404G05CE4"
20 B$="T100L1604DC038AG804CEDEDC038A04DEF#"
30 C$="T100L802B03D02BGG03CEC02A"
40 PLAY A$,B$,C$
50 END
```

CASSETTE SAVE/LOAD OPERATIONS

1. Connections to the CX5M

Please refer to the system connections diagram earlier in this manual, and make the proper connections. For cassette recorders that are not equipped with a remote terminal, only connect the microphone and the earphone (or AUX speaker) jacks.

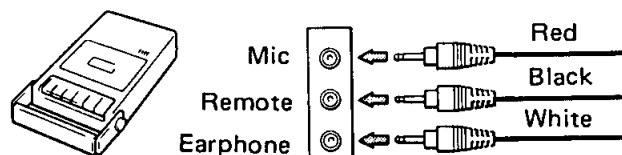

SAVE	SAVE (PLAY + REC)	LOAD	LOAD (PLAY)
------	----------------------	------	----------------

2. Saving Programs to Cassette Tape

Turning off the power of the CX5M will erase everything in memory; that is, the sample program you have just typed in. To keep this program for later use, it should be saved on cassette tape in the following manner:

- (1) Place an appropriate type in the cassette tape recorder.
- (2) Press the RECORD and PLAY keys of the cassette tape recorder simultaneously, activating the recording mode. If the cassette tape recorder is not equipped with a remote terminal, set the cassette tape recorder to the recording mode just before pressing the RETURN key in the next step.
- (3) Type CSAVE, followed by a quotation mark (") and the program name. A second quotation mark at the end of the program name is not necessary. Then press the RETURN key.

csave "GAME 2"

The program name should not exceed 6 characters in length. Upper case and lower case letters and numbers may be used for a program name. We recommend that you make note of the program name and its location on the tape (counter position) for future reference. **Upper and lower case characters are significant.**

- (4) The CX5M will make a clicking sound as a relay operates, and the cassette tape recorder will begin to operate (when using the remote terminal).
 - (5) After the program has been saved, OK will be displayed on the screen and the cassette tape recorder will stop.
- (If the cassette tape recorder is not equipped with a remote terminal, the tape will not stop. Manually press the STOP button of the cassette tape recorder following the OK display on the screen.)

csave "GAME 2"
OK
■

To prevent accidental loss of valuable programs, be sure to make at least one back-up of each program on a separate tape. Do this directly from the computer, as above, not by copying to tape. Tape copies are subject to degradation which may render them unusable.

- (6) After the program has been saved, rewind the tape, press the PLAY button, and then type in the CLOAD? command for verification. (Do not leave the "?" otherwise data stored in the computer may be erased immediately.) If the data has been correctly saved on tape, the screen will show:

```
FOUND: (file-name)
OK
```

and the tape will stop. If the data has not been correctly saved, the screen will show:

```
Verify error
OK
```

If this happens try to save again.

3. Changing the Cassette Baud Rate

Baud rate means the speed at which data is transmitted or received. If you don't specify the baud rate for cassette save, the CX5M will choose 1200 bps.

The baud rate of the cassette can be changed by the appropriate command. During program saving, set the following:

```
csave "{(program name)}" (for 1200 bps)
csave "{(program name)", 0 (for 1200 bps)
csave "{(program name)", 1 (for 2400 bps)
```

A higher baud rate requires better frequency response of the tape recorder and may be unusable due to data errors. Lower baud rates require more time to save and load programs, but may be more reliable with many recorders.

If you don't specify a baud rate, the machine automatically chooses 1200 bps.

The cassette load baud rate is automatically selected.

4. Loading Programs from Cassette Tape

- (1) Set the volume control to slightly higher than the center position, and if the unit is equipped with a tone control, also set this control to slightly past the center position for more treble (high frequency) response.
- (2) Place a cassette tape containing the program to be run into the cassette tape recorder.
- (3) Press the PLAY button of the cassette tape recorder.

If the cassette tape recorder is not equipped with a remote terminal, press the PLAY button after first carrying out the following two steps.

```
MSX BASIC version 1.0
Copyright 1983 by Microsoft
28815 Bytes free
OK
■
cload "GAME 1"
```

- (4) Press the F7 function key (F2 function key while holding down the SHIFT key); cload" will be displayed on the screen, an abbreviation for cassette load.
- (5) Following cload", enter the name of the program to be run (normally printed on the case label of the cassette tape) from the keyboard. For example, if the name of the program to be run is GAME 1, the line should read: cload "GAME 1" (the second quotation mark is optional). Then press the RETURN key.
- (6) The CX5M will make a clicking sound as its relay activates the REMOTE control cable, and the cassette tape recorder will begin to operate (assuming the remote terminal is used).

NOTE:

The program name should be entered exactly as it is listed on the case label of the cassette tape. The program will not be loaded properly unless spaces are entered as spaces, lower case characters entered as such, etc.

- (7) If, during the process of searching for the target program, a program with another name is found (for example "GAME 1" was to be loaded, but a program called "SOUND 1" was found by the computer before finding "GAME 1") skip: SOUND 1 followed by non-target program has been found. In the meantime, the computer will continue to search for "GAME 1".

5. Loading When the Name of the Program is Unknown

- (1) If the RETURN key is pressed without specifying a program, the next program found on the tape will be loaded.
- (2) If you wish to know the names of all programs recorded on the tape, simply enter a simple program name that is not recorded on the tape (for example "UNKNOWN"). Since that program is not on the tape, the skip function will display the name of each program in turn.

```
cload "GAME 1"  
Found: GAME 1  
OK  
■
```

```
cload "GAME 1"  
skip: SOUND 1
```

```
cload "UNKNOWN"  
skip: GAME 1  
skip: GAME 2  
skip: GAME 3  
skip: SOUND 1
```

**FM SOUND
SYNTHESIZER UNIT**

FM SOUND SYNTHESIZER UNIT CONNECTIONS

Review of Basic System Connections

The basic CX5M system, as outlined earlier, consists of the CX5M Music Computer itself, a video monitor, and either the YK-01 or YK-10 Music Keyboard. One of the two Music Keyboards, although sold separately, is necessary to access the FM Sound Synthesizer unit built into the CX5M. Please refer to the system connections diagram earlier in this manual to confirm that connections between these components are properly made.

FM Sound Synthesizer Output

Obviously, a speaker is also required for output of the FM Sound Synthesizer unit. The speaker in your video monitor or TV set can be used for this, or the CX5M can be connected to a stereo amplifier or keyboard amplifier for highest sound reproduction quality. We strongly recommend that, where possible, you use a keyboard amp. in order to realize the full musical potential of the FM Sound Synthesizer unit. The speakers in most stereo systems may not be capable of reproducing its wide dynamic range at high volume levels. Guitar amplifiers lack adequate fidelity. Keyboard amps or wide-range PA systems are best. Connections for each method are described below.

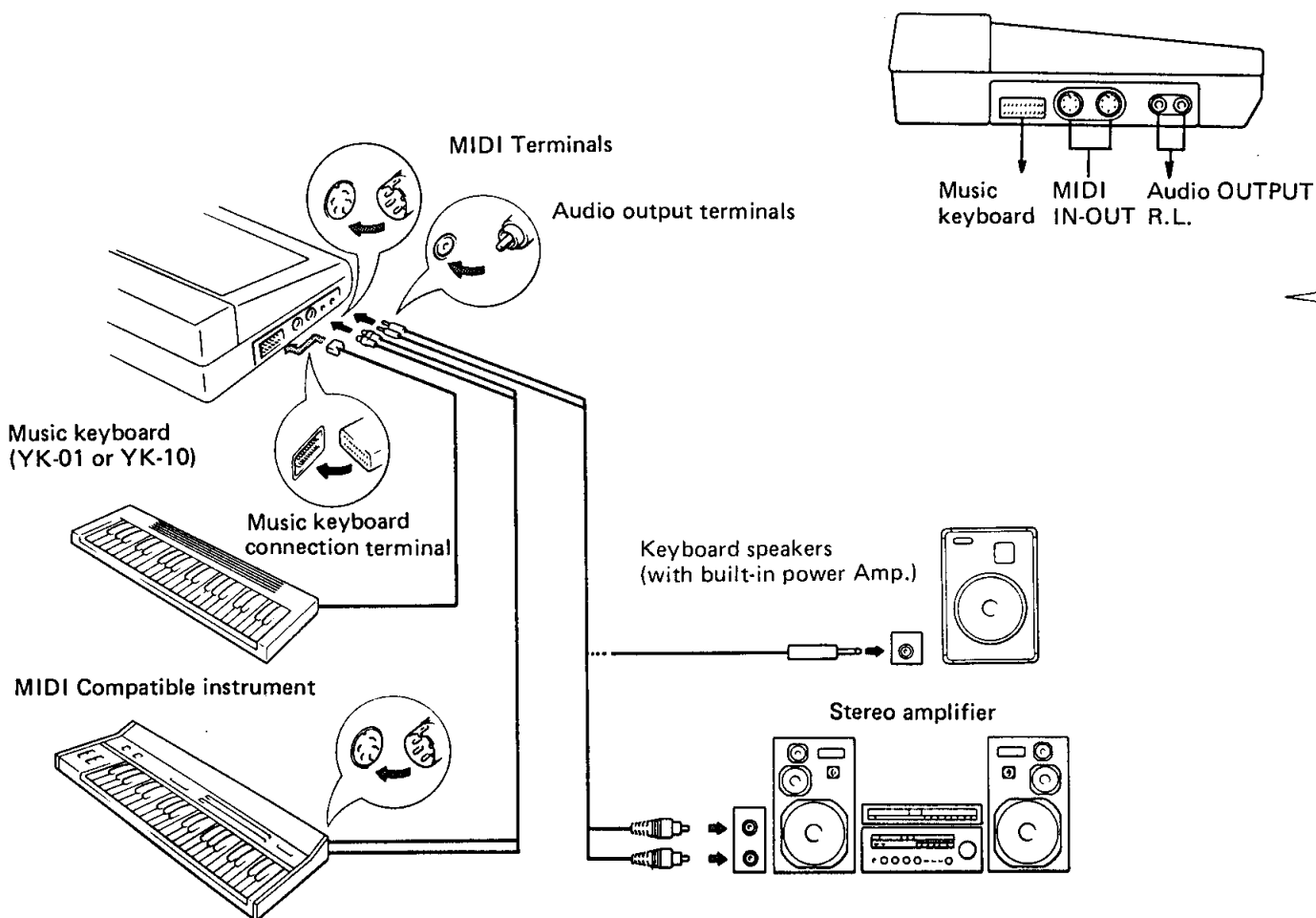

THE "Call Music" COMMAND

The "Call Music" Command

When power is first turned on to the CX5M, the MSX Basic mode is automatically entered. The synthesizer (and therefore, the keyboard) will not function in this mode. To access the FM Sound Synthesizer unit, the command "Call Music", followed by a RETURN, must be input from the CX5M keyboard. (The same command can be entered in the form "_ Music", where "_" is an abbreviation for the word "call"). The screen display shown at the right will appear. The Music Keyboard will now function, and when played at this stage, the BRASS 1 voice (preset voice #1) is automatically selected for both the poly and mono voices.

```
MSX BASIC version 1.0
Copyright 1983 by Microsoft
28815 Bytes free
OK
call music ■
```

1. The CX5M has built-in preamplifier circuitry, allowing you to connect the output of the FM Sound Synthesizer unit directly to a video monitor "audio signal" input terminal. The signal is then monitored via the built-in TV or video monitor speaker. The audio signal is output from the CX5M via the rear-panel DIN jack labelled "MONITOR" (For CX5MU, C only using the VC-02) or RCA type pin labelled "SOUND" (Except CX5MU, C, F using audio connector cable). Please note that the FM Sound Synthesizer output has very high dynamic range, and the sound will most likely be distorted when monitored through a built-in TV speaker. Output volume should be lowered when monitoring the signal in this way.
2. For better sound reproduction quality the FM Sound Synthesizer unit can be connected directly to a stereo or keyboard amplifier. RCA pin-type audio output terminals are found on the left hand side of the CX5M, next to the MIDI In/Out terminals. These are labelled L and R, for the left and right stereo channels. This allows you to monitor output through a high-performance sound system, in stereo. (With preset voices, the same signal is output to both the left and right channels. With the optional FM Voicing Program output for new voices can be directed to each channel.)

DISPLAY SCREEN

The Display Screen

As you can see, the screen is separated into 5 blocks with an additional display area at the bottom of the screen. The red cursor will be in the first block (the poly block) at the top left of the screen. Accessing different blocks on the screen, the items within each block, and selecting different values for each item is done via the CX5M keyboard.

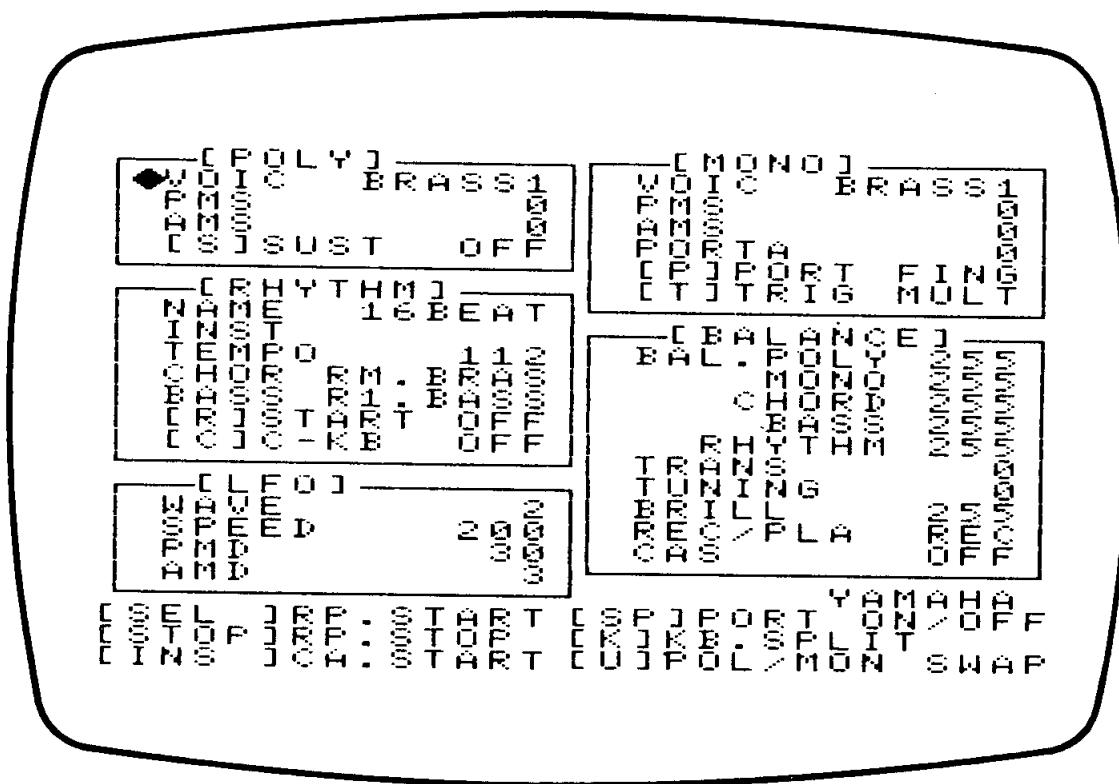

How to Move the Cursor (Red Diamond)

Moving the cursor from block to block can be done with the CX5M function keys. Keys F1 through F5 are pressed to select the POLY, RHYTHM, LFO, MONO, and BALANCE blocks, respectively. The cursor will always go to the first item in a block when a new block is selected. If the function key corresponding to the block in which the cursor already resides is pressed again, the cursor will move to the next item in the block.

Different items within each block may be selected with the RETURN and BS keys. The RETURN key moves the cursor to the next item in the block, and the BS key moves the cursor back to the previous item in the block.

The cursor keys are used for changing the value or setting of the individual items in each block. Use of the cursor keys will be explained later as each block is explained. Menu items shown in square brackets may be selected by pressing the corresponding key on the CX5M keyboard.

The Display Screen and CX5M Keyboard

EXPLANATION OF THE SCREEN

() indicates initial values.

POLY (setting the polyphonic section)

VOIC	Voice	(BRASS 1)
PMS	Pitch Modulation Sensitivity	(0)
AMS	Amplitude Modulations Sensitivity	(0)
(S) SUST	Sustain ON/OFF	

RHYTHM (setting the rhythm and auto-bass chord)

NAME	Rhythm pattern	(16 BEAT)
INST	ON/OFF of Rhythm (R), Bass (B), and Chord (C)	
TEMPO	Speed of the rhythm	(128)
CHORD	Chord voice	(RM. BRAS)
BASS	Bass Voice	(R1. BASS)
(R) START	Start and stop the rhythm	
(C) C-KB	Setting the keyboard to auto-bass chord	

LFO (setting the Low Frequency Oscillator)

WAVE	Waveform of the LFO	(0)
SPEED	Speed of the LFO (frequency)	(0)
PMD	Pitch Modulation Depth (how much the LFO will affect the pitch)	(0)
AMD	Amplitude Modulation Depth (how much the LFO will affect the volume)	(0)

MONO (setting the monophonic section)

VOIC	Voice	(BRASS 1)
PMS	Pitch Modulation Sensitivity	(0)
AMS	Amplitude Modulation Sensitivity	(0)
PORTA	Portamento speed	(0)
(P) PORT	Portamento mode	(FING)
(T) TRIG	Trigger mode	(MULT)

BALANCE (volume balance, other settings)

BAL.	POLY	Poly section volume	(255)
	MONO	Mono section volume	(255)
	CHORD	Chord volume	(255)
	BASS	Bass volume	(255)
	RHYTHM	Rhythm volume	(255)
TRANS		Transpose	(0)
TUNING		Adjusting the tuning less than a half-step	(0)
BRILL		Brilliance (brightness of tone)	(255)
REC/PLA		Select record or play	
CAS		Saving to and loading from the cassette	

MESSAGE

(SEL)	RP. START	Start record or play
(STOP)	RP. STOP	Stop record or play
(INS)	CA. START	Start cassette recorder

(SP)	PORT ON/OFF	Portamento ON/OFF
(K)	KB. SPLIT	Keyboard split
(U)	POL/MON SWAP	Exchange POLY and MONO

The () to the left of some items means that the item may be changed by pressing the key shown inside the (). The cursor will not move to this item.

Function keys move the cursor to the top of each block

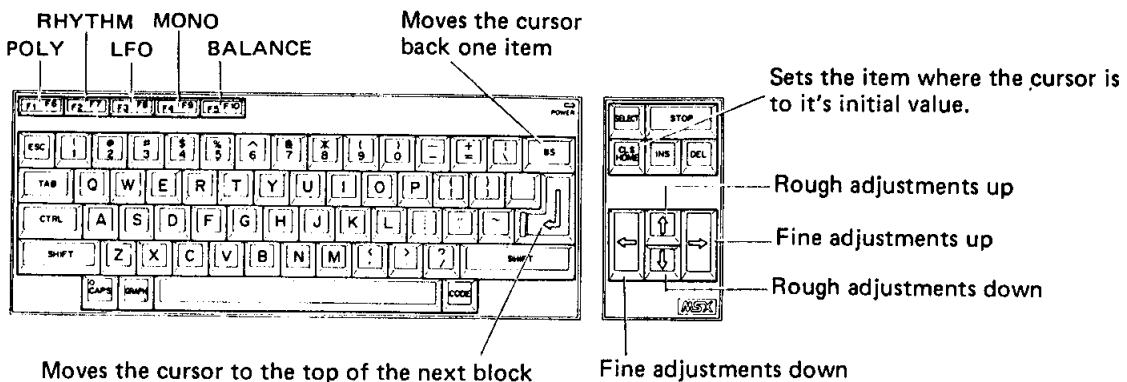

SELECTING THE 46 PRESET VOICES

Selecting the 46 Preset Voices

When the FM Sound Synthesizer unit is first accessed, the poly and mono voices will each be set to BRASS 1, the first voice in the list of preset voices. The keyboard will be split at the center key (C2); the right hand portion of the keyboard will play the mono voice, and the left hand side will play the poly voice. If you wish to change the keyboard split right now, please refer to the appropriate section of this manual for details.

Make sure the cursor is at the Voice item in either the poly or mono block before making a voice selection. The left and right cursor keys are used to select voices; the right cursor key moves forward through the list, and the left cursor key moves backward through the list. Go through the list, playing the keyboard with each new voice to go through the list. You can return to the initial voice by pressing either the F1 function key, or the HOME key on the CX5M keyboard. The up and down cursor keys are used to step through the voice list 8 at a time.

Voice List Chart

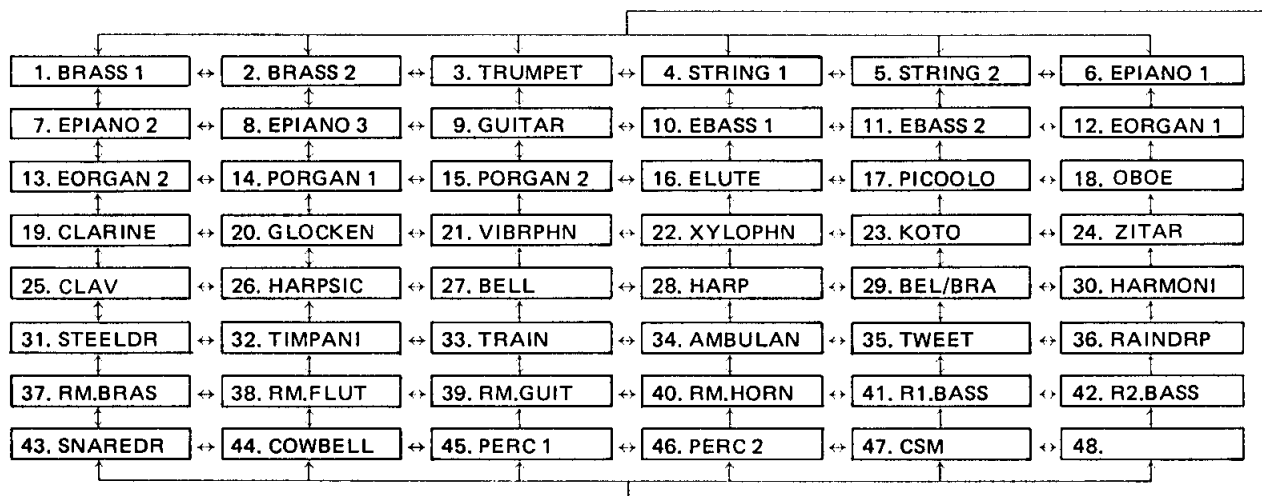

The arrows on the chart correspond to the cursor keys.

Setting Your One "Instant Select" Preset Voice Key

The top row of keys on the CX5M keyboard, keys "0" through "9", can be used to select preset voices of your choice. Keys 1 through 5 will select a poly voice; keys 6 through 0 a mono voice. To preset them as desired, first make a voice selection using the appropriate cursor keys. By pressing the SHIFT key together with a number key (1, for example), the voice currently selected (EPIANO 2, for example) will be preset to that key. This allows you to access those voices most frequently used with a single key-stroke, instead of searching through the list for them one at a time.

These presets will be "valid" only when power to the CX5M remains on. When power is turned off, your presets will be erased, and when power is turned on again, the number keys will access those voices preset at the factory.

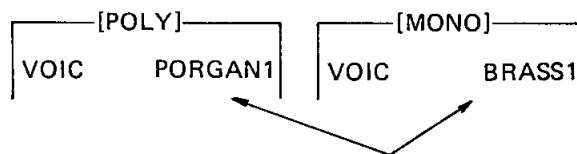

After selecting a desired voice, press the Shift key together with a numeric key (1 through 5 for a Poly voice, 6 through 0 for a Mono voice) to make your own function key preset voices.

POLY	NOMO	Voices Preset to Function Keys
1	6	BRASS 1
2	7	BRASS 2
3	8	TRUMPET
4	9	STRING 1
5	0	STRING 2

KEYBOARD SPLIT

Initial Keyboard Split Setting

When the FM Sound Synthesizer is first accessed with the "Call Music" command, the keyboard is split as shown below. Keys to the right of the C2 center key play the mono voice; those to the left play the poly voice. Since this is an 8-note polyphonic synthesizer, 1 mono note and 7 poly notes (total 8 the entire keyboard) can be played simultaneously.

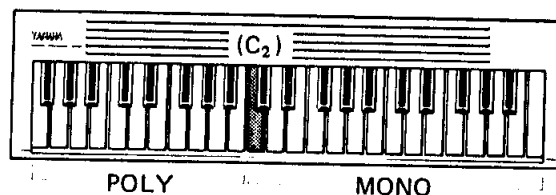

Changing the Keyboard Split Point

Changing the keyboard split point is a simple, 2-step process. First, engage the split function by pressing the "K" key on the CX5M keyboard. The word "YAMAHA" at the lower right portion of the screen will change to "K.SPLIT". Next, select a key on the Music Keyboard and press it. This becomes the new poly/mono split point. The word "K.SPLIT" changes back to "YAMAHA". All keys to the right of the split point will play the mono voice, and all keys to the left of it, including the key pressed, will play the poly voice.

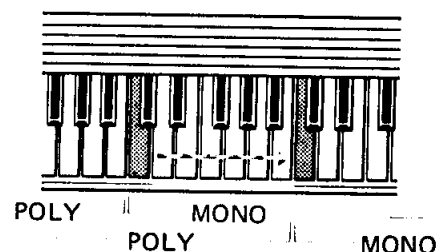

Swapping Poly and Mono

It's not always desirable to have the right hand playing in mono and the left hand in poly, so it's possible to swap them back and forth. Just press the "U" key on the CX5M keyboard, and the Poly and Mono sections of the Music Keyboard will be reversed, without changing the split point. This allows you, for example, to play bass notes in mono with the left hand, and piano chords in poly with the right.

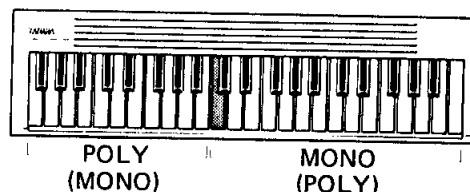

Full Poly or Full Mono Keyboard Setting

It's also possible to set the keyboard for fully polyphonic play, or fully monophonic play. To do this, first press the "K" key on the CX5M keyboard as you would for setting the split point. Then, press the lowest key on the Music Keyboard, and all keys will play the mono voice. If you wish to play the entire keyboard polyphonically, swap mono and poly with the "U" key. In this way, the entire keyboard (except the end key) can be set for fully polyphonic or fully monophonic play, with a single voice.

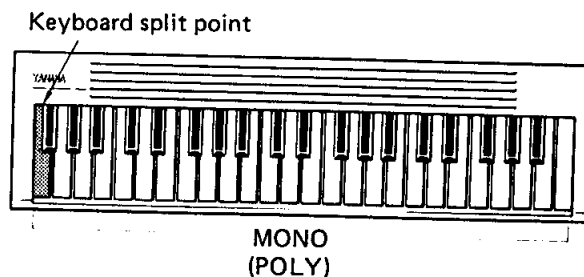

ADDING RHYTHM

Adding rhythm Accompaniment

The FM Sound Synthesizer unit has 6 built-in rhythm patterns which can be selected to accompany keyboard play.

1. Selecting a rhythm pattern

Press F2 or use the RETURN or BS key to move the cursor to the first item in the rhythm block, NAME. This lets you select a rhythm pattern. (see list)
Move through the list with the right and left cursor keys.

2. Press RETURN to move the cursor to the next item, INST. This allows you to add the various elements of the rhythm pattern; Rhythm, Bass, and Chord, in any combination you want. Move through the combinations with the cursor keys, until "R" appears next to INST.

3. Starting the rhythm

Press the "R" key on the CX5M keyboard, and the [R] START item in the rhythm block will change to ON. Now, press any key on the Music Keyboard, and the rhythm will start.

4. Move the cursor to TEMPO and change the tempo as you please. (Up and down for large changes, right and left for small changes.)

5. To adjust the volume of the rhythm, bass and chord, move the cursor to the BALANCE block and use the cursor keys to set the balance.

NOTE:

The S and C in the INST indicate if the chord pattern will sound only while you are pressing a key (C), or if the chord will continue sounding as part of the auto bass chord (S). (See next page)

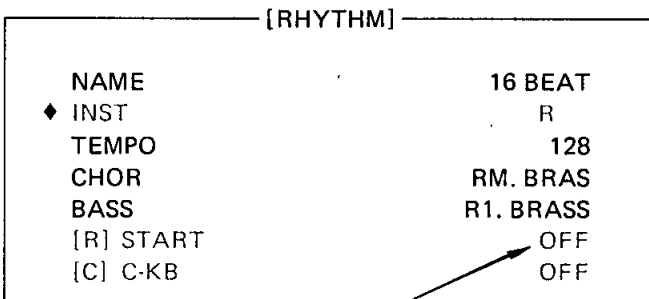
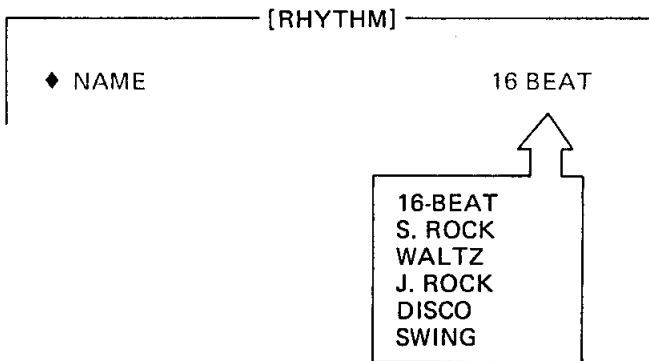

When you press the R key, this will change to ON.

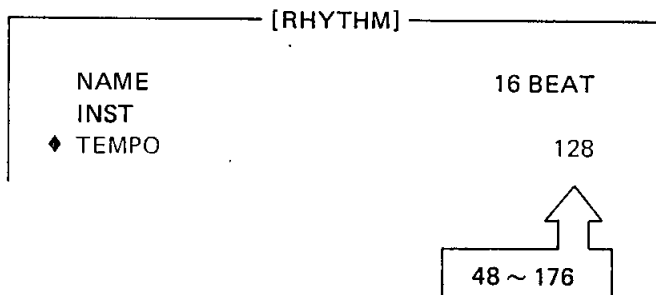

ADDING AUTO BASS CHORD

Adding Auto Bass Chord Accompaniment

First make sure the INST line is set to RBS. Now press the "C" key on the CX5M keyboard. This switches the (C)-KB item ON; pressing the "C" key again turns it off. This sets the lower 14 keys of the Music Keyboard aside for auto bass chord accompaniment; when any of these keys is pressed during rhythm play, the bass note is set and auto bass chord accompaniment begins. These 14 keys will be reserved for auto bass chord play when the (C)-KB function is ON, taking precedence over the poly (or mono) voice selected for that portion of the keyboard (If you are using the YK-10).

The bass note will automatically be synchronized with the rhythm pattern, and the accompanying chord pattern will automatically be synchronized with the bass note. The bass note changes when you press another key on the music keyboard, and the accompanying chord pattern automatically changes with it. The chord remains synchronized to the new bass note. For example: if DO is pressed as the bass note, it will be accompanied by DO MI SO. If SO is pressed, it will be accompanied by a SO TI RE chord. Once a key is pressed it is recorded into memory and chord pattern accompaniment will be repeated even after the key is released. Therefore, it is only necessary to press a new bass note key when you wish to change the chord.

Note that this happens only when the "S" function has been selected in the INST line of the Rhythm block. The "C" function also generates automatic bass accompaniment, but without synchronized chords. That is, a chord is produced only when a key is pressed. Also, take your fingers completely off the keys before trying to change chords; otherwise, the chords may not change. Press the key of the next chord only after you have released the previous keys.

NOTE:

✱ In Auto Bass chord, there 5 keys will not function.
(For YK-10)

[RHYTHM]	
NAME	16 BEAT
INST	RBC
TEMPO	128
CHOR	RM. BRAS
BASS	R1. BASS
[R] START	ON
[C]-KB	OFF

[RHYTHM]	
NAME	16 BEAT
INST	RBS
TEMPO	128

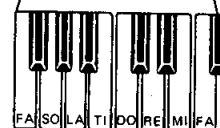
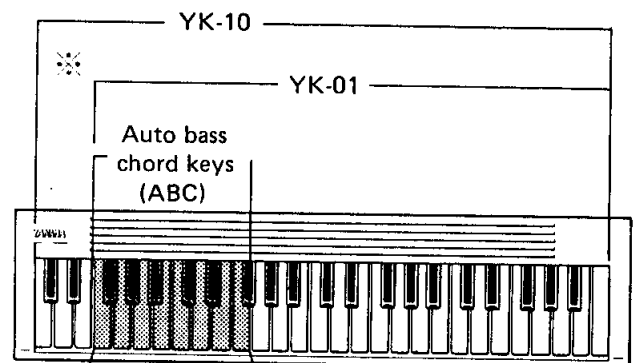

F G A B C D E F ← If you press the keys.
 SO LA TI DO RE MI FA }
 TI DO RE ME FA SO LA } These chords will be played.
 RE MI LA SO LA TI DO }

SEVENTH CHORDS

Seventh Chords and Minor Chords

Accompaniment is not limited to major chords. Seventh and minor chords can be produced by depressing two or three keys simultaneously, as shown in the figure to the left. Keep in mind that these fingerings merely represent instructions to the computer, and would not necessarily yield the chords played on the music keyboard.

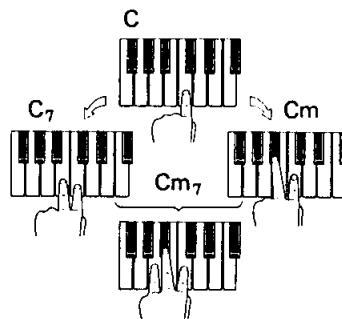

Changing the Rhythm and Bass Voices

There are four preset voices available for use as the chord voice in auto bass chord accompaniment: RM. BRASS, RM. FLUT, RM. GUIT, and RM. HORN. These are selected by moving the cursor to the CHOR line in the Rhythm block and using the cursor keys. Two bass voices are also selectable for the bass line: R1 BASS and R2 BASS. These are accessed with the cursor keys after moving the cursor to the BASS line in the Rhythm block.

C7 Chord

Press a white key to the left of the key pressed for a major chord, together with the chord root key to produce a seventh chord.

Cm Chord

Press the black key immediately to the left of the key pressed for a major chord, together with the chord root key, to produce a seventh chord.

Cm7 Chord

Press the black key immediately to the left of the key pressed for a major chord, and a white key to the left of root key, along with the chord root key, to produce a minor seventh chord.

RECORDING KEYBOARD PLAY

The CX5M has a built-in memory feature which allows you to record and playback keyboard performances without the use of a cassette recorder. This is particularly useful for practice on keyboard technique, "instant replays" when trying out new phrases and compositions, and auto accompaniment (playback of recorded performances can be accompanied by real-time keyboard play). Further, since only performance data is recorded; voices, key, etc. can be changed during playback. This feature is accessed from the Balance block, on the REC/PLA line.

Recording

Make sure that the item REC/PLA is set to REC. Press the SELECT key to initiate recording (as indicated on the menu at the bottom of the screen), which begins as soon as this key is pressed. Press the STOP key to end recording. These options are also displayed in the bottom left hand portion of the screen, and the current status (REC or PLA) is displayed directly under the Rhythm block on the display screen. Press the STOP key to end recording.

NOTE:

The amount of memory available for recording is determined not by time, but by the actual number of notes played. The CX5M has a capacity of about 2000 notes. If this limit is reached during actual recording, the recording will end at that point automatically. The automatic bass line and/or rhythm accompaniment is not recorded, and must be manually selected to accompany playback.

Playback

To play back the recorded material, select the PLA option with the cursor keys and press the SELECT key. Changing the voice (with the POLY or MONO voice functions) and key (with the TRANSPOSE function) is possible prior to and during playback.

NOTE:

When accompanying a recorded performance with "live" keyboard playing, the section of the keyboard reserved for a mono voice will not play over the recorded performance.

CASSETTE SAVE/LOAD OPERATIONS

Save

The performance data recorded into the CX5M computer memory can be recorded onto cassette tape, thereby saving data that would otherwise be erased when the CX5M power is turned off. Connecting and operating a cassette recorder is explained earlier in this manual; the same procedures apply here.

- (1) Move the cursor to CAS of the BALANCE block, and press the cursor key to set it so that EV.W is displayed.
- (2) Next, simultaneously press the RECORD and PLAY keys of the cassette recorder, setting it to the record mode.
- (3) When the INS key is pressed, the CX5M will produce a clicking sound and the cassette recorder will begin operating.
- (4) The cassette recorder will stop operating upon completion of data recording.

Load

- (1) Move the cursor to CAS of the BALANCE block, and press the cursor key, setting it so that EV.R is displayed.
- (2) Press the PLAY key on the cassette recorder.
- (3) When the INS key is pressed, loading will begin and the cassette recorder will stop operating when loading is complete.

Loading Voice Data

Voices created with the Yamaha FM Voicing Program can also be used with the FM Sound synthesizer unit for keyboard play by loading the voice data from cassette tape.

- (1) Move the cursor to CAS of the BALANCE block, and press the cursor key so that VC.R is displayed.
- (2) Follow the procedures described in LOAD above.

For details on loading new FM voices, please consult the YAMAHA FM Voicing Program manual.

[BALANCE]

BAL.	POLY	255
	MONO	255
	CHORD	255
	BASS	255
	RHYTHM	255
TRANS		0
TUNING		0
BRILL		255
REC/PLA		REC
◆ CAS		EV.W

CAS/RUN

BRILL	255
REC/PLA	REC
◆ CAS	VC.R

CAS/RUN

BRILL	255
REC/PLA	REC
◆ CAS	OFF

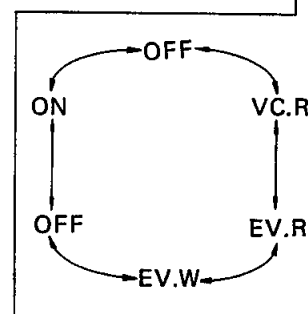

NOTE:

There are certain types of cassette recorders in which the fast-forward and rewind functions will not operate when CAS is in any of the OFF, VC.R, EV.R, and EV.W modes. If this occurs, set CAS to ON before operating the fast-forward or rewind functions.

If you wish to terminate operations while data is being recorded or loaded, press the CTRL + STOP keys and the cassette recorder will stop operation.

MODIFYING EFFECT PARAMETERS

The LFO Block

The FM Sound Synthesizer unit has one LFO, which applies to all voices. Each voice has its own preset LFO parameters which modulate the voice, yet those can be modified to create your own degree of modulation.

Wave (Waveform)

The shape of the LFO waveform determines how pitch and/or volume are varied. There are four different waveform shapes which can be selected, as shown in the diagram below.

LFO WAVEFORMS

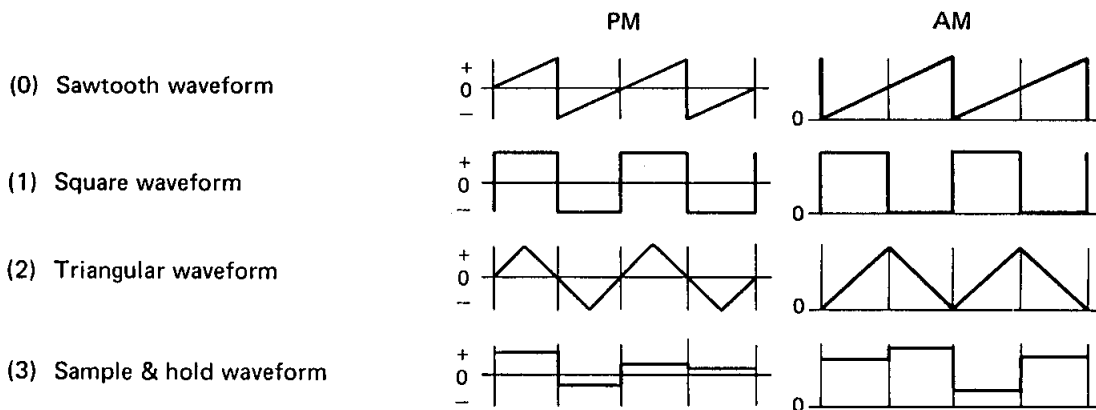

Speed (LFO Frequency)

This sets the speed, or frequency of the waveform, within an approximate range of 0.008Hz to 53Hz. The greater the speed, the faster the rate of modulation.

PMD (Pitch Modulation Depth)

This sets the amount of LFO modulation available in relation to pitch. The range of pitch variation is from 0 to 127, with 0 producing no pitch change and 127 producing maximum pitch change potential.

AMD (Amplitude Modulation Depth)

This sets the amount of LFO modulation available in relation to volume. The range of variation is from 0 to 127.

Modifying LFO Parameters

The modulation sensitivity valves for each voice determine how much that voice is affected by the LFO. All parameters in the LFO Block are equally applied to the POLY and MONO voices. Notice that in the Poly and Mono blocks, there are settings for pitch modulation sensitivity (PMS) and amplitude modulation sensitivity (AMS). These are used in conjunction with the PMD and AMD parameters to determine the actual degree of modulation. Although the distinction between depth and sensitivity is not great, it is important to understand in terms of using these parameters effectively.

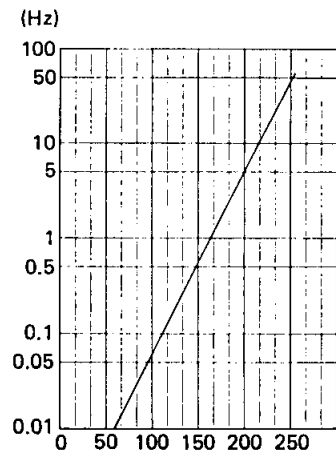

(LFO speed of the display screen : 0 ~ 255)

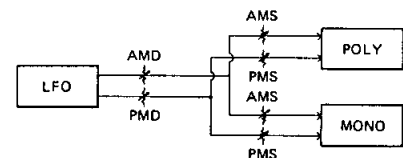

Simply speaking, the modulation depth determines the audible "range" of modulation produced by the LFO, while modulation sensitivity determines the "extent" of modulation within that available range which is actually applied to the Poly or Mono voice parameters. In both the Poly and Mono blocks, PMS has a value range of 0 to 7, and AMS has a value range of 0 to 3. When either of these sensitivity values is set to 0, no modulation will be heard no matter how great the modulation depth. Pitch modulation sensitivity and amplitude modulation sensitivity have preset values for each voice as do the LFO settings, although you may alter the settings as desired.

Sustain

A sustain effect can be added to poly voices. Pressing the "S" key on the CX5M keyboard turns Sustain on and off. This effect prolongs the release time of the notes played. Some voices are affected more than others.

Portamento

Portamento can be added to all Mono voices. This function is found in the Mono block, and has a range of values from 0 to 255. All mono voices will have an initial Portamento value of 0 (no effect), and this can be changed by first accessing the PORTA item in the mono block, then changing the value with the cursor keys. The left and right cursor keys provide changes in increments of 1, while the up and down cursor keys provide changes in increments of 8. Portamento is turned on and off with the CX5M space bar. This option is indicated in the menu at the lower right hand portion of the display screen.

The (P) PORT item has two settings — FING (fingered) and FULL (full time), and initially the FING position will be set. In the FING mode, portamento is applied only when keys are played in legato; that is, when a second key is pressed while the first key pressed is still held down. In the FULL mode, the portamento effect is applied to all keys pressed, whether alone or together with other keys. These two options are selected alternately by pressing the "P" key on the CX5M keyboard.

The (T) TRIG (trigger) mode controls the initial attack of each key pressed, with two selectable options. In the MULT mode, attack is maintained with each key pressed, even if another key is held down. In the SING mode, the attack of all notes following an initial note which is held will be removed, resulting in a legato playing style. That is, in the SING mode, attack will be applied to only a single note at a time.

The Balance Block

Several items in the Balance block have already been explained. Those yet not explained are the TRANS, TUNING, and BRILL items. These items are accessed, and changed, in the same way as all items on the screen, using the RETURN and BS keys and the cursor keys.

Trans (Transpose)

The Transpose function allows you to change the key of the Music Keyboard in coarse or fine increments. Using the left and right cursor keys, the value can be changed in increments of 1 semitone; using the up and down cursor keys, the value will be changed in increments of 8. The range of values is from -24 to +24 (± 2 octaves).

Tuning

This function provides extremely fine tuning capability, varying the pitch of the keyboard within a range of -128 to +127, which represents just under plus or minus 1 semitone.

Brill (Brilliance)

This function allows you to vary the brilliance, or brightness, of a voice. The range of values is from 192 to 255, with the higher value providing the brightest response. A good speaker system may be required to distinguish subtle differences in BRILL values.

MIDI COMPATIBILITY

The FM Sound Synthesizer unit has built-in MIDI (Musical Instrument Digital Interface) compatibility which allows various instruments and computers to communicate with the CX5M. Any MIDI compatible instrument or device can be used with the CX5M.

MIDI Connections

The diagram below shows how MIDI connections are made. IN of one unit is connected to the corresponding OUT of the other.

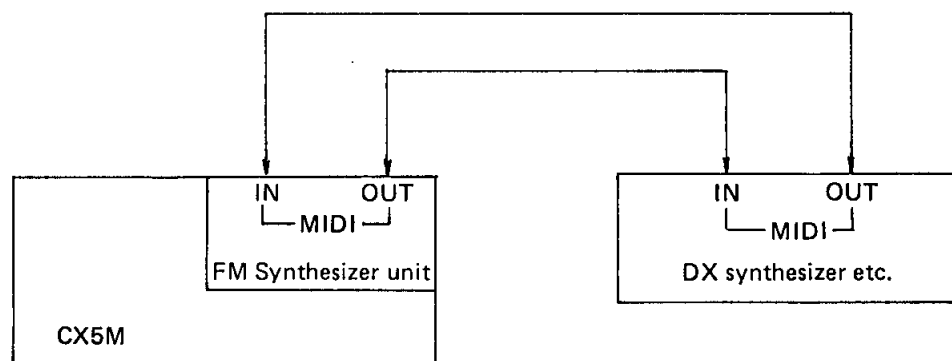

The Yamaha DX-7, DX-9 or other MIDI-compatible musical instruments equipped with a POLY mode can be played remotely with the Music Keyboard by simply connecting a MIDI cable. Playing the Music Keyboard will simultaneously produce notes on the DX-7, or DX-9. (There is no function which allows the DX to play through the CX5M). Please consult the operating manual of your DX-7, DX-9, or other MIDI compatible equipment for details on MIDI channel transfer.

FM VOICE LIST

This table lists internal voices of the FM Sound Synthesizer unit.

Use the voice number when setting the voices with the FM Music Composer.

1 Bright brass	17 Piccolo	33 Train
2 Sonorous brass	18 Oboe	34 Ambulance
3 Trumpet	19 Clarinet	35 Chirping of a small bird
4 Sonorous strings	20 Glöckenspiel	36 Sound of raindrops
5 Real strings also suited for the playing of single notes	21 Vibraphone	37 Brass
6 Electronic piano 1	22 Xylophone	38 Flute
7 Electronic piano 2	23 Koto	39 Guitar
8 Electronic piano 3	24 Zitar	40 Horn
9 Mild guitar	25 Funky clarinet	41 Funky electric bass
10 Funky electric bass	26 Harpsicord	42 Mild electric bass
11 Mild electric bass	27 Bell	43 Snare drum
12 Electric organ 1	28 Harp	44 Cow bell
13 Electric organ 2	29 Short notes are bell, long notes are brass	45 Percussion 1
14 Majestic pipe organ	30 Harmonica	46 Percussion 2
15 Small pipe organ	31 Steel drum	47 CSM
16 Flute	32 Timpani	48 _____

**ADDITIONAL
INFORMATION**

KEYBOARD MODES

Normal

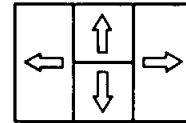
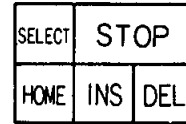
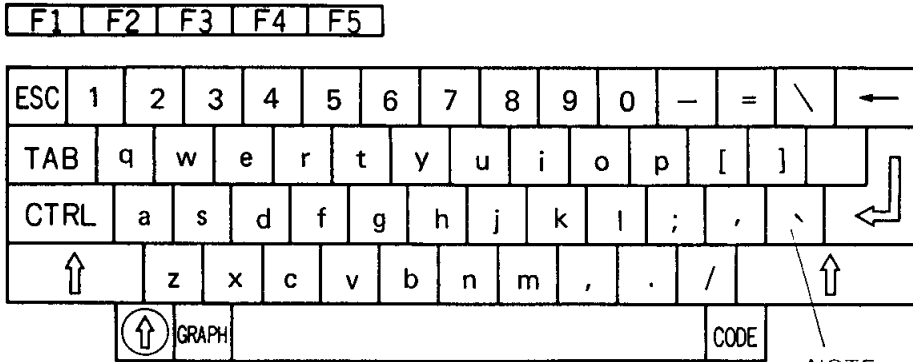

NOTE:
Only the CX5MU, C
All other models have this key.



Normal + Shift Keys

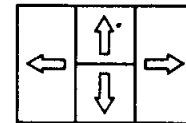
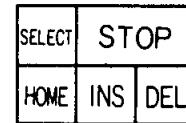
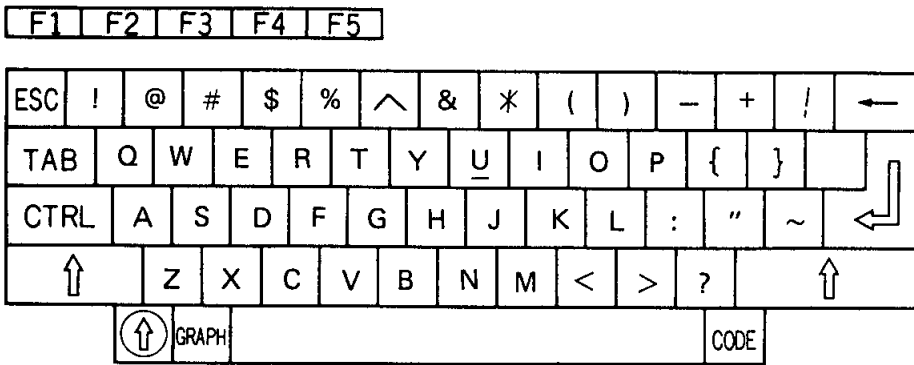

Code Key

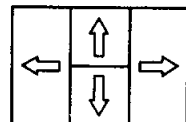
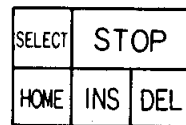
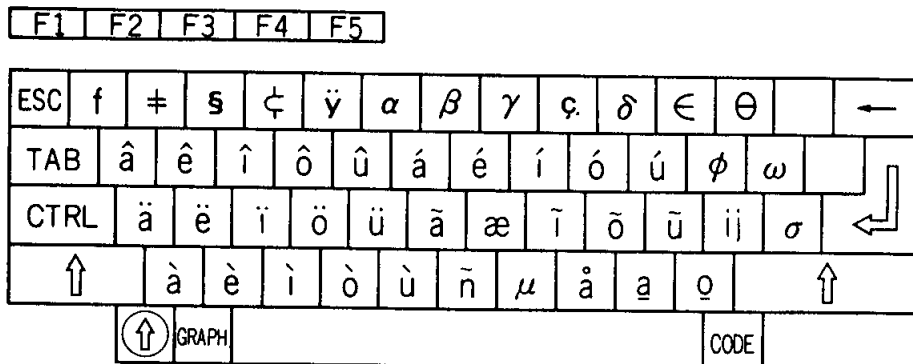

Code + Shift Keys

F6 | F7 | F8 | F9 | F10

ESC	i	¶	Π	£	¥			Γ	Ç	Δ			←
TAB							É		π	Φ	Ω		↵
CTRL	Ä			Ö	Ü	Ã	Æ	Ï	Õ	Û	Ÿ	Σ	↵
↑						Ñ	Å		¿				↑
⬆	GRAPH												CODE

SELECT	STOP	
CLS	INS	DEL

←	↑	→
	↓	

Graph Key

F1 | F2 | F3 | F4 | F5

ESC	¼	½	¾	□	∕	↑	√	∞	·	○	-	±	∖	←
TAB	≡	▶	▼	┌	┐	└	┘	▬	▭	▮	▯	☺	♪	↵
CTRL	-	⊗	⊙	┌	+	└	┘	▬	▭	▮	♠	♣	~	↵
↑	☼	⊗	◇	┌	┐	└	┘	♂	≤	≥	∕			↑
⬆	GRAPH													CODE

SELECT	STOP	
HOME	INS	DEL

←	↑	→
	↓	

Graph + Shift Keys

F6 | F7 | F8 | F9 | F10

ESC		2	n			↓			◐	◑	+	≡		←	
TAB	≡	◀	▶	┌		└	▬	▭	▮	▯	⊗	●	♪	↵	
CTRL		⊗	⊙	▬	▭	▮	▯	▬	▭	▮	▯	♠	♥	≈	↵
↑	○	+	-	▬	▭	▮	▯	♀	<<	>>	÷			↑	
⬆	GRAPH													CODE	

SELECT	STOP	
CLS	INS	DEL

←	↑	→
	↓	

ASCII CORD TABLE

Graphic codes in the following chart can be designated by CHR \$& (hex).

	0	1	2	3	4	5	6	7	8	9	A	B	C	D	E	F
0		†		0	@	P	`	p	Ç	É	á	Ã	▬	◀	α	≡
1	☺	⊥	!	1	A	Q	a	q	ü	æ	í	ã	▬	⊗	β	±
2	☹	⊥	"	2	B	R	b	r	é	Æ	ó	Ï	▬	⊗	Γ	≥
3	♥	⊥	#	3	C	S	c	s	â	ô	ú	ĩ	▬	▬	Π	≤
4	♦	⊥	\$	4	D	T	d	t	ä	ö	ñ	Õ	▬	▬	Σ	ƒ
5	♣	⊥	%	5	E	U	e	u	à	ò	Ñ	õ	▬	▬	σ	J
6	♠		&	6	F	V	f	v	å	û	ä	Û	▬	▬	μ	÷
7	·	—	'	7	G	W	g	w	ç	ù	ó	ũ	▬	▬	γ	≈
8	■	└	(8	H	X	h	x	ê	ÿ	¿	IJ	▬	Δ	Φ	○
9	○	└)	9	I	Y	i	y	ë	Ö	└	ij	▬	‡	θ	●
A	◉	└	*	:	J	Z	j	z	è	Ü	└	¾	▬	ω	Ω	-
B	♂	└	+	;	K	[k	{	ï	¢	½	~	▬	▬	δ	√
C	♀	×	,	<	L	\	l		î	£	¼	◇	▬	▬	∞	n
D	♪	/	-	=	M]	m	}	ì	¥	ı	‰	▬	▬	φ	²
E	♫	\	.	>	N	^	n	~	Ä	Pt	《	π	▬	▬	ε	▬
F	⚙	⊥	/	?	O	_	o	△	Å	f	》	§	▬	▬	η	

CONTROL CODE TABLE

The following table shows the function of each key when pressed together with the CTRL key.

Keyboard	Decimal	Hexadec	Function
A	1	01	Header for graphic character
B	2	02	Moves cursor to beginning of word
C	3	03	Interrupts input wait status or
D	4	04	Ignored (ends AUTO command mode)
E	5	05	Deletes the line after the cursor
F	6	06	Moves cursor to next word
G	7	07	Bell
H	8	08	Backspace
I	9	09	Same as TAB key
J	10	0A	Line feed
K	11	0B	Moves cursor to home position
L	12	0C	Clear screen
M	13	0D	Carriage return
N	14	0E	Moves cursor to last sentence
O	15	0F	Ignored
P	16	10	Ignored
Q	17	11	Ignored
R	18	12	Inserts a character to the left
S	19	13	Ignored (of the cursor)
T	20	14	Ignored
U	21	15	Deletes line where the cursor is
V	22	16	Ignored
W	23	17	Ignored
X	24	18	Ignored
Y	25	19	Ignored
Z	26	1A	Ignored
[27	1B	Ignored
/	28	1C	Cursor right
]	29	1D	Cursor left
^	30	1E	Cursor up
-	31	1F	Cursor down
DEL	127	7F	Delete character where cursor is

BASIC COMMAND LIST

Commands		
AUTO	AUTO [start] [, increment]	Automatic line numbering to speed up text entry
CONT	CONT	Continues execution after STOP statement or Control-STOP.
DELETE	DELETE line range	Erases groups of lines from memory.
LIST/LLIST	LIST [line num] [- line num] LLIST [line num] [- line num]	Displays your program on the screen. Displays your program on the printer.
NEW	NEW	Erases all of your program and does a CLEAR
RENUM	RENUM [new] [, old] [, increment]	Renumbers lines in memory.
RUN	RUN [(line number devfilename)]	Starts execution of program; enters run mode.
SAVE/LOAD MERGE	SAVE devfilename LOAD devfilename [, R] MERGE devfilename	Saves program to tape in ASCII text format. Loads program from tape; must be in ASCII text format. Adds a program from tape in ASCII text format to one in RAM.
BASE (System numeric variable)	BASE (tabentry)	Allows VRAM locations for VDP tables to be set, all SCREENs  0 5 10 15 : Base of Name Table 6 11 : Base of Color Table 3 7 12 17 : Base of Pattern Generator Table 8 13 18 : Base of Sprite Attribute Table 9 14 19 : Base of Sprite Pattern Table
BSAVE/BLOAD	BSAVE devfilename, start addr, end addr [, run addr] BLOAD devfilename [, runoption] [, offsetaddr]	Saves a block of memory to tape in pure binary image format. Loads into RAM a binary image stored on tape.
CSAVE/CLOAD CLOAD?	CSAVE filename, speed CLOAD [filename] CLOAD? [filename]	Saves program to tape in internal format. Loads program from tape; must be in internal format.
TRON/TROFF	TRON TROFF	Turns on line number trace during execution. Turns off line number trace during execution.
Statements		
CLEAR	CLEAR (string size [, freespace])	Reserves RAM for string space and/or non-BASIC use; and also erases all variables, open files, etc.
CALL	CALL routine name [(parameter list)]	Activates an expanded BASIC statement capability.
CLOSE	CLOSE ([#] bufnum) [, [#] bufnum)	Ends I/O with specified file number.
DATA	DATA element [, element]	Specifies list of internal data items.
DIM	DIM varname [, varname]	Defines, reserves, and initializes arrays.
DEFINT DEFSNG DEFDBL DEFSTR	DEFINT vartype range [, range] DEFSNG vartype range [, range] DEFDBL vartype range [, range] DEFSTR vartype range [, range]	Defines default variable type.
DEFFN	DEFFN varname [(argvar [, argvar])] = expression	Specifies user-defined functions.
DEFUSR	DEFUSR [digit] = intexpr	Specifies starting location of user-defined machine-language function.
ERASE	ERASE array name [, array name]	Deletes the specified array.
END	END	Finishes execution, returns to direct mode
ERROR	ERROR errnum	Statement which will cause any error to occur.
FOR ~ NEXT	FOR variable = start TO stop [STEP increment] NEXT variable	Loop statement; changes value of loop control variable ends a loop started with a FOR statement.
GOSUB ~ RETURN	GOSUB line number RETURN	Calls new line number. Ends a subroutine, returns to statement after GOSUB.
GOTO	GOTO line number	Jumps to new line number.
IF ~ THEN/ IF ~ GOTO	IF conditional expr THEN statement list IF conditional expr GOTO line number	Selects different options based on condition.
IF ~ THEN ~ ELSE	IF conditional expr THEN statement list ELSE statement list	Selects different options based on condition.

IF ~ GOTO ~ ELSE	IF conditional expr GOTO line number IF conditional expr ELSE statement list	Selects different options based on condition.
INPUT	INPUT [(# filename,)] variable list "prompt"	Reads in data items; must be in proper format.
KEY/KEY LIST	KEY (keynum, stringexpr) KEY LIST	Re-defines the use of the special function key. KEY LIST lists on the screen entire text of all 10 function keys.
LINE INPUT	LINE INPUT [(# filename,)] string var "stcons";	Returns entire line of input, unformatted.
LET	[LET] variable expression	General variable assignment statement; the LET is optional.
MAXFILES	MAXFILES = numexpr	Specifies number of I/O files to reserve space for.
MID \$	MID \$ (str var, start char [, length]) = strexpr	In place replacement of string variable with new value.
ON ERROR GOTO	NO ERROR GOTO line number	Specifies error trapping and location of handler.
ON GOTO/ GOSUB	ON numexpr (GOTO) list of line numbers ON numexpr (GOSUB) list of line numbers	Case statement, does a GOTO based on variable value. Case statement, does a GOSUB based on variable value.
~ ON/OFF/STOP	KEY (keynum) ON/OFF/STOP STRIG (num) ON/OFF/STOP STOP ON/OFF/STOP SPRITE ON/OFF/STOP INTERVAL ON/OFF/STOP	Specifies function key-based interrupt. Specifies joystick trigger interrupt. Specifies Control-Stop interrupt. Specifies sprite collision interrupt. Specifies timer-based interrupt.
ON ~ GOSUB	ON (INTERVAL) = ticks ON (KEY) BOSUB line num [, line num] ON (SPRITE) GOSUB line num [, line num] ON (STOP) GOSUB line num [, line num] ON (STRIG) GOSUB line num [, line num]	Defines location of interrupt handler.
OPEN	OPEN devfilename [FOR (APPEND)] AS [#] filename OPEN devfilename [FOR (INPUT)] AS [#] filename OPEN devfilename [FOR (OUTPUT)] AS [#] filename	Associates file number with device name; initializes. CAS: Cassettetape CRT: CRT display GRP: Graphics screen LPT: Printer
OUT	OUT address, data	Sends data to Z-80 output port.
POKE	POKE loc, data	Stores data in any RAM location.
PRINT/LPRINT	PRINT [filename,] print list LPRINT [filename,] print list	Sends data to file I/O device/sends data to printer.
PRINT/LPRINT USING	PRINT USING [filename,] [format:] print list LPRINT USING [filename,] [format:] print list	Option on PRINT statements for formatted output.
PRINT #/ INPUT #	PRINT [# filename,] print list INPUT [# filename,] variable list	Sends data to text display screen. Returns prompted input, must be in proper format.
READ	READ variable [, variable]	Inputs data from DATA statement to variable.
REM	REM any text	Statement that is totally documentary.
RESTORE	RESTORE [line number]	Resets pointer to allow DATA to be re-READ.
RESUME	RESUME RESUME 0 RESUME NEXT RESUME [line number]	Specifies end of error handler and where to continue at.
STOP	STOP	Temporarily stops execution with message, may be restarted.
SWAP	SWAP (numeric variable, numeric variable) string variable, string variable	Switches values of two variables; fast and totally in place.
TIME	TIME = numexpr	MSX BASIC keeps an internal 16-bit counter which it continually updates, at 60 times per seconds. Set the system clock.
WAIT	WAIT port, and [, xor]	Reads Z-80 input port and waits until condition is met.
VDP (System numeric variable)	VDP (reg num)	Allows access to actual VDP registers.
Graphics and Sound Statements		
BEEP	BEEP no parameters	Sounds alarm beep and resets all sound output.
CIRCLE	CIRCLE [@] [STEP] (x, y), radius [, color] [startangle], [, endangle] [, aspect]	Draws circle, arcs, wedges, and ovals.
CLS	CLS	Clears screen to background color.

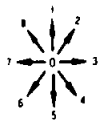
COLOR	COLOR [colornum] [, colornum] [, colornum]	Sets default foreground; background; (not SCREEN 0) border color. Here are the color numbers: 0 TRANSPARENT 8 MEDIUM RED 1 BLACK 9 LIGHT RED 2 MEDIUM GREEN 10 DARK YELLOW 3 LIGHT GREEN 11 LIGHT YELLOW 4 DARK BLUE 12 DARK GREEN 5 LIGHT BLUE 13 MAGENTA 6 DARK RED 14 GREY 7 CYAN 15 WHITE
DRAW	DRAW string expr	Uses Graphics Macro Language to draw entire objects.
LINE	LINE [[@] [STEP] (x1, y1) – [@] [STEP] (x2, y2) [, color] , <BF>]	Draws lines, hollow boxes, filled-in boxes.
LOCATE	LOCATE [x] , [y] , [switch]	Moves text cursor and turns it on or off.
PUT SPRITE	PUT SPRITE sprnum [, [@] [STEP] (x, y)] [, color] [, sprimage]	Actually controls display of 32 possible sprites.
PAINT	PAINT [@] [STEP] (x, y) [, color] [, strexpr]	Fills any enclosed area with any color.
PLAY	PLAY [strexpr] [, strexpr] [, strexpr]	Uses Music Macro Language to play 3-part background music.
PSET/PRESET	PSET [@] [STEP] (x, y) [, color] PRESET [@] [STEP] (x, y) [, color]	Resets any point on screen to background color. Sets any point on screen to foreground color.
SCREEN	SCREEN [mode] [, sprite] [, key click] [, tape speed] , [, printer]	Sets display screen type and sprite size SCREEN MODE 0 : Text mode (40 x 24 characters) 1 : Text mode (32 x 24 characters) 2 : Highestresolution mode 3 : Multicolor mode SPRITE SIZE 0 : 8 x 8 pixels 2 : 16 x 16 pixels 1 : 8 x 8 pixels (large) 3 : 16 x 16 pixels (large)
SPRITE \$	SPRITE \$ (num) = stringexpr	Accesses 64 or 256 possible sprite data patterns.
VPOKE	VPOKE address, data	Writes data directly to any location in VRAM.
ON/OFF	KEY: ON/OFF MOTOR ON/OFF	Turn function key prompt line on or off. Turn cassette motor on and off.
SOUND	SOUND register, setting	Allows access to actual PSG registers.
WIDTH	WIDTH size	Sets with of text screens. numeric expression in range 1 – 32 if SCREEN 1, or 1 – 40 if SCREEN 0
String Functions		
BIN \$	BIN \$ (integer expression)	Converts integer to binary notation in character string.
POINT	POINT (x, y)	Returns color of any point on screen.
VPEEK	VPEEK (address)	Reads any location in VRAM. Address :: = a numeric expression in range 0 – 16383
STICK	STICK (which)	Read digital joystick which :: = numeric expression in range 0 – 3, 0 = keyboard, 1 and 2 = joystick sockets 1 and 2. 
STRIG	STRIG (num) <ON/OFF/STOP>	Reads trigger buttons from joystick.
PDL	PDL (choice)	Reads game paddles (knobs).
PAD	PAD (select)	Reads graphics pad (tablet).
TIME	TIME	Return the system clock.

Nameric Functions		
ABS	ABS (numexpr)	Absolute value.
ASC	ASC (stringexpr)	Converts string character to corresponding character code.
ATN	ATN (numexpr)	Arctangent; inverse tangent of angle given in radians.
CDBL	CDBL (numexpr)	Converts to double-precision BCD-format type.
CHR \$	CHR \$ (numexpr)	Converts numeric value to corresponding one-byte character.
CINT	CINT (numexpr)	Converts to 16-bit signed integer type.
COS	COS (radangle)	Cosine of angle in radians.
CSNG	CSNG (numexpr)	Converts to single-precision BCD-format type.
CSRLIN	CSRLIN	Returns row text cursor is on.
EXP	EXP (exponent)	E raised to the power of n.
EOF	EOF (filenum)	Indicates whether end-of-file mark reached yet.
ERL	ERL	Contains line number of last error.
ERR	ERR	Contains error number of last error.
FRE	FRE (dummy argument)	Unused RAM available or unused string space available.
FIX	FIX (numexpr)	Strips off any fractional part, returning whole number only.
HEX \$	HEX \$ (numexpr)	Converts integer to hex notation in character string.
INKEY \$	INKEY \$	Returns the character (or a null) string from the keyboard.
INPUT \$	INPUT \$ (number [, [] filenum])	Returns specified number of raw, unechoed bytes.
INSTR	INSTR ([start,] string, substring)	Position of substring in a string.
INT	INT (numexpr)	Rounds down number to next lower whole part.
LEFT \$	LEFT \$ (string expr, length)	Substring of specified number of characters, from left.
LEN	LEN (string expr)	Length of string.
LOG	LOG (numarg)	Natural (base e) logarithm
LPOS	LPOS (1)	Return printer column position.
MID \$	MID \$ (strexpr, start char [, length])	Extracts specified substring from anywhere in string.
OCT \$	OCT \$ (integer expression)	Converts integer to octal notation in character string.
PEEK	PEEK (addr)	Reads data from any memory location.
POS	POS (arg)	Returns column text cursor is on.
RIGHT \$	RIGHT \$ (strexpr, numexpr)	Substring of specified number of characters, from right.
RND	RND (numexpr)	Pseudo random number generator.
SGN	SGN (numexpr).	Signum function.
SIN	SIN (numexpr)	Sine of angle in radians.
SPACE \$	SPACE \$ (length)	Generates string of any length containing blank spaces.
SPC	PRINT . . . SPC (length)	PRINT command function producing blank spaces.
SQR	SQR (numexpr)	Square root.
STR \$	STR \$ (numexpr)	Converts number to character string containing the number.
STRING \$	STRING \$ (len, <numexpr/stringxpr>)	Generates string with repeated characters.
TAB	PRINT . . . ; TAB (column); . . .	PRINT command function producing blank spaces to any point.
TAN	TAN (angle)	Tangent of angle in radians.
USR	USR [digit] (expression)	Invoke user-defined machine-language that is previously set up function.
VAL	VAL (strexpr)	Converts character string containing digits to number.
VARPTR	VARPTR ((variable/# file number))	Return pointer to location of variables and files in memory.

ERROR MESSAGES

ERROR MESSAGES	MEANING · CAUSE
NEXT without FOR	A variable in a NEXT statement does not correspond to any previously executed, unmatched FOR statement variable.
Syntax error	A line is encountered that contains some incorrect sequence of characters (such as an unmatched parenthesis, misspelled command or statement, incorrect punctuation, etc.)
RETURN without GOSUB	A RETURN statement is encountered for which there is no previous, unmatched GOSUB statement.
Out of DATA	A READ statement is executed when there are no DATA statements with unread data remaining in the program.
Illegal function call	A parameter that is out of range is passed to a math or string function. An "Illegal function call" error may also occur as the result.
Overflow	The result of a calculation is too large to be represented in BASIC number format. If underflow occurs, the result is zero and execution continues without an error.
Out of memory	A program is too large, or has too many FOR loops, GOSUBs, or too many variables.
Underfined line number	A nonexistent line is referenced in a GOTO, GOSUB, IF ... THEN ... ELSE, or DELETE statement. A new program line that contains only the line number, also causes this error.
Subscript out of range	An array element is referenced either with a subscript that is outside the dimensions of the array or with the wrong number of subscripts.
Redimensioned array	Two DIM statements are given for the same array; or, a DIM statement is given for an array after the default dimension of 10 has been established of that array.
Division by zero	A division by zero is encountered in an expression; or the operation of involution results in zero being raised to a negative power.
Illegal direct	A statement that is illegal in direct mode is entered as a direct mode command.
Type mismatch	A string variable name is assigned a numeric value or vice versa; a function that expects a numeric argument is given a string argument or vice versa.
Out of string space	String variables have caused BASIC to exceed the amount of free memory remaining which has been allocated for string operations by CLEAR statement.
String too long	An attempt is made to create a string more than 255 character long.
String formula too complex	A string expression is too long or too complex. The expression should be broken into smaller expressions.
Can't continue	An attempt is made to continue a program that: <ol style="list-style-type: none"> 1. Has halted due to an error. 2. Has been modified during a break in execution. 3. Does not exist.
Underfined user function	A USR function is called before the function definition (DEF statement) is given.
Device I/O error	An error occured on an I/O device operation.
Verify error	The contents of memory and the contents of a file turn out to be different. This error may occur when using CLOAD? command.
No RESUME	An error handling routine is entered but contains no RESUME statement.
RESUME without error	A RESUME statement is encountered before an error handling routine is entered.
Unprintable error	An error message is not available for the condition that exists.
Missing operand	An expression contains an operator with no operand following it; a command/statement is given without its compulsory parameters.
Line buffer overflow	An attempt is made to INPUT a line that contains more than 255 characters.
Field overflow	A FIELD statement is attempting to allocate more bytes than were specified for the record length of a random file.
Internal error	An internal malfunction has occurred in MSX BASIC. Report to Microsoft the conditions under which the message appeared.
Bad file number	A statement or command references a file with a file number that is not OPEN or is out of the range of file numbers specified at initialization.
File not found	A LOAD, KILL, NAME, or OPEN statement/command references a file that does not exist on the current disk.
File already open	A sequential output mode OPEN statement is issued for a file that is already OPEN; or a KILL statement is given for a file that is OPEN.
Input past end	An INPUT statement is executed after all the data in the file has been INPUT, or for a null (empty) file. To avoid this error, use the EOF function to detect the end of file.
Bad file name	An illegal form is used for the filename with a LOAD, SAVE, KILL, or OPEN statement (e.g., a filename with too many characters).
Direct statement in file	A direct statement is encountered while LOADING an ASCII file. The LOAD is terminated.
Sequential I/O only	A GET, or PUT statement is used with a file that has been OPENed as a sequential file.
File not OPEN	An I/O command/statement is used with a file that has not been OPENed.

TROUBLESHOOTING

Check the following items if you CX5M appears to malfunction during use. If it cannot be returned to normal working order, disconnect the power plug and contact your nearest service center.

PROBLEM	CAUSE	CURE
The POWER lamp is not lit when the POWER switch is turned ON.	The unit is not connected to a wall outlet, or the wall outlet is "dead".	Connect the unit to a wall outlet, or check the outlet voltage.
Nothing appears on the screen.	There is no power to the monitor or TV.	Turn on the power.
	The connections are improper.	Connect the units correctly.
	The ROM cartridge is incorrectly inserted.	Insert the ROM cartridge correctly.
	The TV tuner is not set to the same channel as the TV adaptor.	Match the channels of the TV and the TV adaptor.
	The fine tuning, brightness and contrast of the TV are improperly adjusted.	Adjust the fine tuning, brightness and contrast.
The reception signal is weak.	The TV tuner is not set to the same channel as the RF adaptor.	Match the channels of the TV and the TV adaptor.
	The fine tuning of the TV requires adjustment.	Fine tune the TV.
	The connections of the TV adaptor are incorrect.	Connect the TV adaptor correctly.
The ROM cartridge does not operate.	The cartridge is not fully inserted.	Fully insert the cartridge.
	The terminals of the cartridge are dirty.	Clean off the terminals.
A program cannot be loaded from cassette tape.	The cables of the cassette recorder are incorrectly connected.	Correctly connect the cables.
	The volume of the cassette recorder is too low.	Raise the volume of the cassette recorder.
	The phase is incorrect (for units having adjustable phase).	Correctly set the phase.
The CX5M "hangs" or stops during use.	Momentary loss of power. The POWER switch is turned OFF.	Turn the power on. Operation of the unit will resume, but any programs stored in the unit will have been erased.
	The power cord is disconnected. Interference free other electric devices entering the power cord.	Use a wall outlet where the effects of vacuum cleaners, microwave ovens, etc. are not present, or use an AC line filter.
	The connection of peripheral devices is incorrect.	Connect the peripheral devices correctly.

SPECIFICATIONS

1) CPU

Z80A (Clock frequency 3.57954MHz)

2) Memory

Main memory 32 KB
 Video RAM 16 KB
 ROM 32 KB

3) Keyboard

73 keys
 Alpha-numeric keys and graphic characters x 49
 Control codes, etc x 15
 Cursor movement keys x 4
 Function keys x 5

4) Video Out Specifications

Characters: Alpha-numeric and graphic patterns
 256 characters with 8 x 8 dot matrices
 Color graphics: 16 colors with 256 x 192 resolution
 32 sprites

5) Music Function

8 octaves 3 notes and noise

6) Cassette Data Recorder Interface

FSK 1200 BPS or 2400 BPS
 8 pin DIN connector

Pin#	Signal	Connection
1	GND	
2	GND	
3	GND	
4	CMTOUT	
5	CMTIN	
6	REM+	
7	REM-	
8	GND	

7) Video/Audio Out CX5MU, C

NTSC composite out (video) 5 pin DIN connector

Pin#	Signal	Connection
1	+5V	
2	GND	
3	SOUND	
4	VIDEO	
5	NC	

7) Video/Audio Out (Except CX5MU, C, F)

Connect with RCA type pin connection cables.

7) Video/Audio Out CX5MF

Pin#	Signal	Connection
1	GND	
2	SOUND	
3	AV	
4	Y	
5	YS	
6	R	
7	G	
8	B	

8) Joystick Interface

9 pin type-D connector x 2 TTL connection

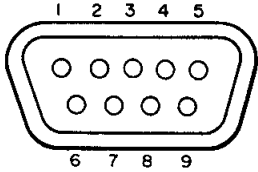
Pin#	Signal	Connection
1	FWD	
2	BACK	
3	LEFT	
4	RIGHT	
5	+5V	
6	TRG1	
7	TRG2	
8	OUT	
9	GND	

9) Printer Interface

8 bits parallel Centronics 14 pins TTL connection

Following conditions need to be met to produce hard copies.

- 1) More than 640 dots/line [or 480 dots/line so long as a double mode (960 dots/line) can be selected by ESC + "P"]
- 2) The bit image command to be ESC + "S".

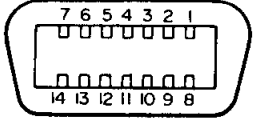
Pin#	Signal	Connection
1	PSTB	
2	PD0	
3	PD1	
4	PD2	
5	PD3	
6	PD4	
7	PD5	
8	PD6	
9	PD7	
10	NC	
11	BUSY	
12	NC	
13	NC	
14	GND	

10) ROM Cartridge Slot (game slot)

No.	Name	I/O	No.	Name	I/O	No.	Name	I/O
1	CS1	O	2	CS2	O	3	CS12	O
4	SLTSL	O	5	N/C	-	6	RFSH	O
7	WAIT	I	8	INT	I	9	MI	O
10	BUSDIR	I	11	IORQ	O	12	MERQ	O
13	WR	O	14	RD	O	15	RESET	O
16	N/C	-	17	A9	O	18	A15	O
19	A11	O	20	A10	O	21	A7	O
22	A6	O	23	A12	O	24	A8	O
25	A14	O	26	A13	O	27	A1	O
28	A0	O	29	A3	O	30	A2	O
31	A5	O	32	A4	O	33	D1	I/O
34	D0	I/O	35	D3	I/O	36	D2	I/O
37	D5	I/O	38	D4	I/O	39	D7	I/O
40	D6	I/O	41	GND	-	42	CLOCK	O
43	GND	-	44	SW1	-	45	+5V	-
46	SW2	-	47	+5V	-	48	+12V	-
49	SUNDIN	I	50	-12V	-			

MSX standard 50 pin connector

11) Extension Side Slot Pin Assignment (60 pin connector)

No.	Name	I/O	No.	Name	I/O	No.	Name	I/O
1	SOUND OUT	O	2	GND		3	GND	
4	Phase Control	I	5	Y	O	6	B-Y	O
7	C VIDEO	O	8	R-Y	O	9	EXT CLOCK	I
10	CLOCK INT/EXT	I	11	CS1	O	12	CS2	O
13	CS12	O	14	SLTSL	O	15	N/C	-
16	RFSH	O	17	WAIT	I	18	INT	I
19	MI	O	20	NO CONNECTION	-	21	IORQ	O
22	MERQ	O	23	WR	O	24	RD	O
25	RESET	O	26	N/C	-	27	A9	O
28	A15	O	29	A11	O	30	A10	O
31	A7	O	32	A6	O	33	A12	O
34	A8	O	35	A14	O	36	A13	O
37	A1	O	38	A0	O	39	A3	O
40	A2	O	41	A5	O	42	A4	O
43	D1	I/O	44	D0	I/O	45	D3	I/O
46	D2	I/O	47	D5	I/O	48	D4	I/O
49	D7	I/O	50	D6	I/O	51	GND	-
52	CLOCK	O	53	GND	-	54	SW1	-
55	+5V	-	56	SW2	-	57	+5V	-
58	+12V	-	59	SOUND IN	I	60	-12V	-

12) Rear Slot Pin Assignment
(based on MSX standard —50 pins)

No.	Name	I/O	No.	Name	I/O	No.	Name	I/O
1	CS1	O	2	CS2	O	3	CS12	O
4	SLTSL	O	5	N/C	—	6	RFSH	O
7	WAIT	I	8	INT	I	9	MI	O
10	BUSDIR	I	11	IORQ	O	12	MERQ	O
13	WR	O	14	RD	O	15	RESET	O
16	N/C	—	17	A9	O	18	A15	O
19	A11	O	20	A10	O	21	A7	O
22	A6	O	23	A12	O	24	A8	O
25	A14	O	26	A13	O	27	A1	O
28	A0	O	29	A3	O	30	A2	O
31	A5	O	32	A4	O	33	D1	I/O
34	D0	I/O	35	D3	I/O	36	D2	I/O
37	D5	I/O	38	D4	I/O	39	D7	I/O
40	D6	I/O	41	GND	—	42	CLOCK	O
43	GND	—	44	SW1	—	45	+5V	—
46	SW2	—	47	+5V	—	48	+12V	—
49	SUNDIN	I	50	—12V	—			

13) General Specifications (CX5MU, C)

AC power supply: AC 120V ± 10% 50/60Hz
 Power consumption: max 27 watts
 Operation condition: temperature 0-35°C
 humidity less than 80%
 Dimensions: 423W x 60H x 200D (mm)
 Weight: 2.9 kg

14) General Specifications (Except CX5MU, C)

AC power supply: AC 220V ± 10% 50/60Hz
 (CX5MH, B: AC 110/220V can be change)
 Power consumption: max 27 watts
 Operation condition: temperature 0-35°C
 humidity then 80%
 Dimensions: 423W x 60H x 200D (mm)
 Weight: 2.8 kg

Power supply unit — Dimensions: 245W x 60H x 100D (mm)
 Weight: 1.1 kg

15) FM Sound Synthesizer Unit

Sound generator: FM Sound Generator
 4 operator 8 algorithm
 Polyphony: 8 note simultaneous
 Internal voices: 46 presets
 Connections: Audio output (L, R)
 MIDI-IN, MIDI-OUT
 Music keyboard connector
 Audio output:
 Level: -9 dBm
 FLUTE voice, 440 ~ 880Hz
 8 note simultaneous output
 Impedance: 1.8 kΩ
 Temperature range: 0 ~ 35°C
 Humidity range: 20 ~ 80%

CX5M SOFTWARE AND PERIPHERAL OPTIONS

FM Music Composer YRM-101

When connected to the Yamaha CX5M Music Composer equipped with the Yamaha FM Sound Synthesizer unit, the Yamaha FM Music Composer software cartridge enables computer aided music composition and orchestration, and full performance control of all compositions. Notes are entered directly onto a music score displayed on the video monitor screen, and on-screen indication of phrasing, dynamics and performance control data is also provided.

FM Music Composer Features

- Music composition with up to 8 separate parts can be performed automatically. Different voices can be used for each separate part, and changed at any time, permitting full orchestration control.
- Notes are entered from either the CX5M ASCII keyboard or from a Yamaha YK-01 or YK-10 Music Keyboard. The external keyboard facilitates easier note entry, and also permits keyboard accompaniment of "automatic" performances (performances which are electronically "recorded" and "played" by the computer.
- Notation for dynamics (crescendo, decrescendo, etc.) and tempo (ritardando, atempo, etc.) is entered from the computer keyboard, enabling a wide range of expressive control.
- The FM Music Composer can be used for automatic performance whereby compositions are played back on Yamaha's DX synthesizers and other MIDI compatible instruments.
- The full music score, along with all performance control data, can be converted to "hard copy" (printed out) with a suitable MSX-compatible external printer and/or saved on cassette tape or data memory cartridge (UDC-01).

FM Voicing Program YRM-102

The Yamaha FM Voicing Program software cartridge permits you to use the CX5M to create synthesizer voices and play them back by means of the CX5M's built-in FM Sound Synthesizer unit. While a rich assortment of preset voices is included with the FM Sound Synthesizer unit, the FM Voicing Program further expands the creative potential of the CX5M by permitting creation of new voices, as well as modification of existing voices.

FM Voicing Program Features

- The FM Voicing Program enables you to modify all the voices which come preset into the FM Sound Synthesizer unit. It also enables you to create entirely new voices from scratch.
- Voices are created and edited by entering data from the CX5M computer keyboard. All data is visually displayed in real time on the monitor screen. Voice creation can also be audibly monitored and sampled in real time by playing a Yamaha Music Keyboard which is connected to the computer.
- All voice data (the parameters of voices you edit or create) can be saved on cassette tape or data memory cartridge (UDC-01). The voice data later can be used for performance when the CX5M is equipped with the Yamaha FM Music Composer or the FM Music Macro program cartridges.
- All voice data, and a complete listing of the names of all voices, can be converted to "hard copy" with an optional external printer.

DX-7 Voicing Program YRM-103

The DX-7 Voicing Program software cartridge enables the CX5M computer to be used for editing or creating voices for the Yamaha DX-7 Digital Programmable Algorithm Synthesizer. The DX-7 is connected to the CX5M via the FM Sound Synthesizer MIDI terminals. The DX-7 Voicing Program provides extremely efficient voice programming, with on-screen graphic displays of all voicing parameters.

DX-7 Voicing Program Features

- All DX-7 voicing parameters are displayed on the screen, for easier, more efficient voice programming. Envelope generator and keyboard scaling data can be displayed numerically and graphically, for real-time visual confirmation of these parameters as they are changed.
- LFO (Low Frequency Oscillator) settings and other voice modifying parameters can also be stored in CX5M memory, so each distinct voice will have its own characteristic setting.
- All voice data, and a full listing of all voices, can be converted to "hard copy" with an external printer, saved on cassette tape, and/or stored on UDC-01 Data Memory cartridges and DX-7 RAM cartridges. LFO settings and other voice modifying parameters can also be stored on external memory.
- Editing of voice data can be done from either the CX5M or from the DX-7 itself.

Yamaha FM Music Macro YRM-104

The Yamaha FM Music Macro software cartridge allows the voicing and performance potential of the Yamaha FM Sound Synthesizer unit to be used within the framework of an MSX Basic program. Versatile Basic commands are provided for voice selection, music composition, and automatic performance. These special commands are used in a Basic program along with the full range of commands available in MSX Basic, adding the vast potential of the Yamaha FM Sound Synthesizer unit to standard Basic programming.

Yamaha FM Music Macro Features

- Up to four different voices may be used for simultaneous performance, providing dynamic musical performance capability within a Basic program.
- Music may be composed with up to 8 separate parts.
- Preset rhythm patterns may also be selected and modified for automatic performance along with the other synthesized voices.
- For a wider range of expressive control, volume and pitch may also be modified during performance of an individual voice.
- Performance data can be output to Yamaha DX synthesizers and other MIDI compatible instruments.

Printer, Joysticks, etc.

Only printers specified as being MSX compatible may be used with the CX5M. Only joysticks, paddles, touch pads, and other peripheral devices specified as being MSX compatible may be used with the CX5M.

MSX Software Cartridges

In addition to the ROM software cartridges made available by Yamaha, the CX5M will also run any ROM software cartridge specified as being compatible with an MSX computer.

SINCE 1887  **YAMAHA**
NIPPON GAKKI CO., LTD. HAMAMATSU, JAPAN