

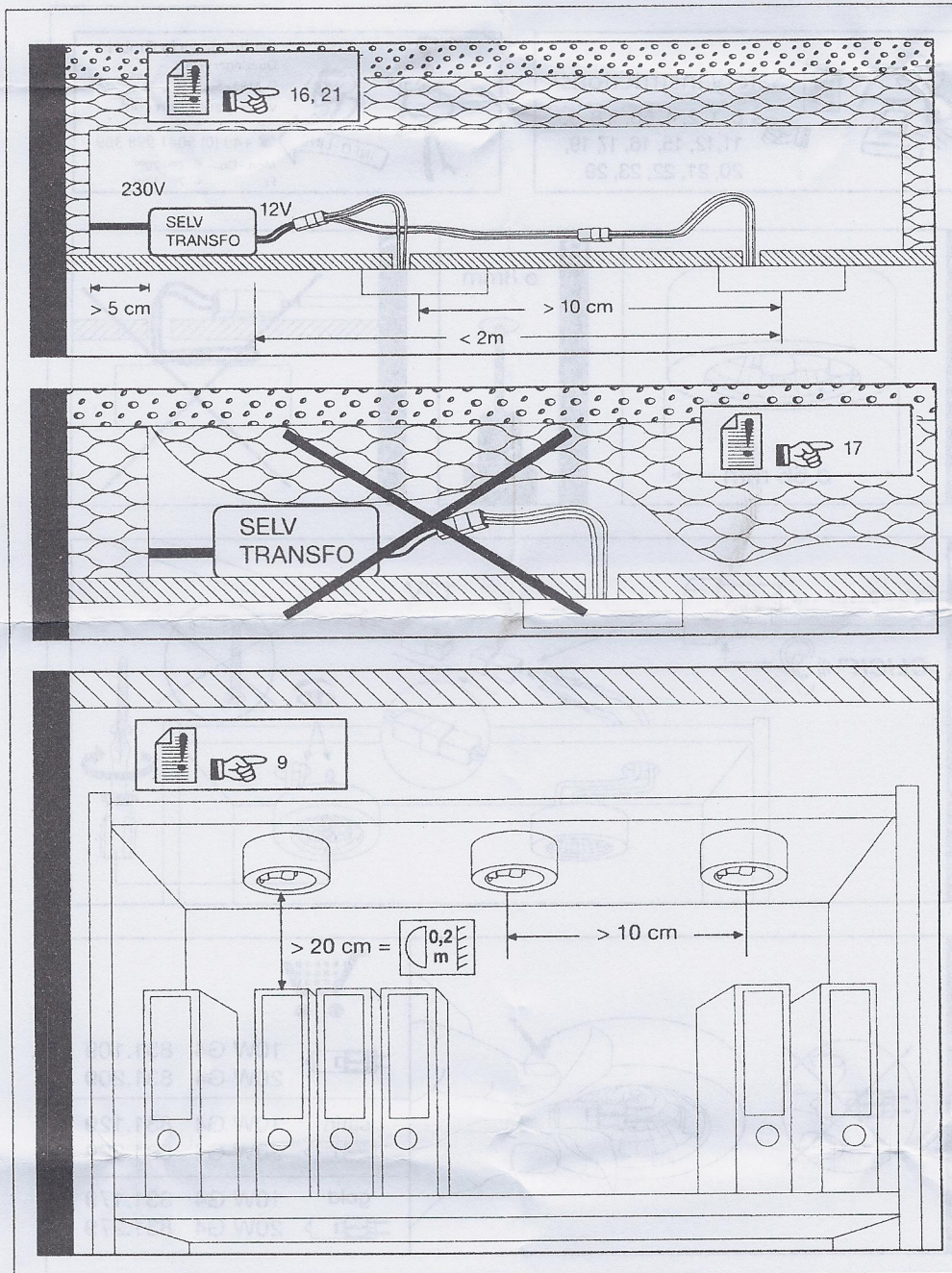

08K04 v02 - 507 000 318  
(+MA 173)







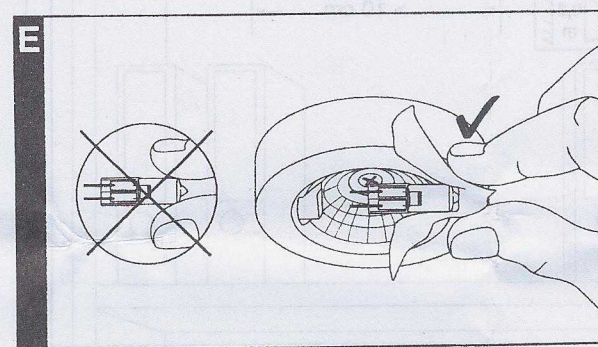
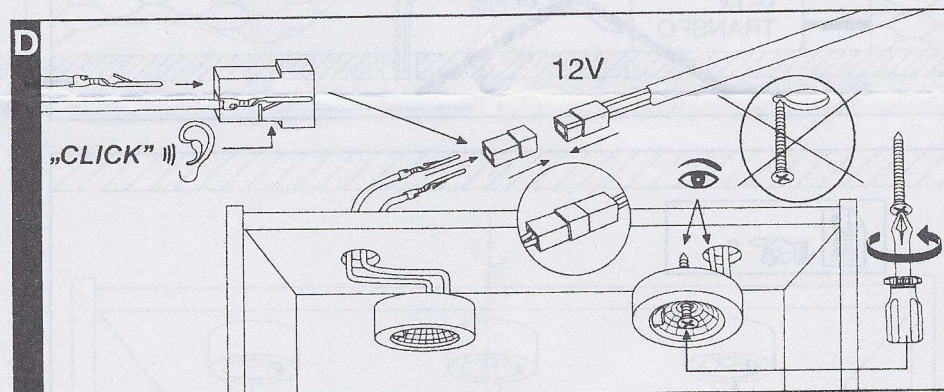
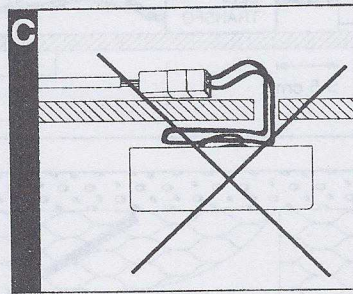
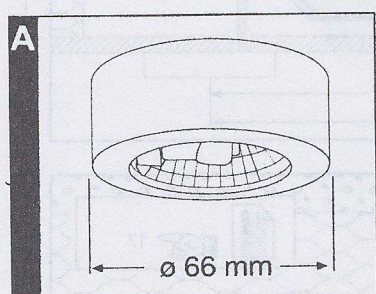

08K04 v02 - 507 000 318  
 (+MA 173)

 **Safety Instructions**  
 0, 1, 2, 4, 5b, 7, 8, 9,  
 11, 12, 15, 16, 17, 19,  
 20, 21, 22, 23, 29

 **INFO-LINE**  
 Paulmann Licht GmbH  
 Quezinger Feld 2  
 D-31832 Springe  
 www.paulmann.com  
 ☎ +49 (0) 5041 998 389  
 Mon.-Do. ☎ 7<sup>00</sup> - 20<sup>00</sup>  
 Fr. ☎ 7<sup>00</sup> - 17<sup>00</sup>



		
	10W G4	831.109
	20W G4	831.209
	satin 10W G4	831.129
	20W G4	831.229
	gold 10W G4	831.179
	20W G4	831.279