

TEKTRONIX®

7D12 A/D CONVERTER

M1, M2, M3

WITH OPTIONS

OPERATORS

INSTRUCTION MANUAL

Tektronix, Inc.
P.O. Box 500
Beaverton, Oregon 97005

Serial Number _____

DIGITALY REMASTERED
OUT OF PRINT- MANUAL SCANS

By

Artek Media

18265 200th St.
Welch, MN 55089

www.artekmedia.com

“High resolution scans of obsolete technical manuals”

If your looking for a quality scanned technical manual in PDF format please visit our WEB site at www.artekmedia.com or drop us an email at manuals@artekmedia.com and we will be happy to email you a current list of the manuals we have available.

If you don't see the manual you need on the list drop us a line anyway we may still be able to point you to other sources. If you have an existing manual you would like scanned please write for details. This can often be done very reasonably in consideration for adding your manual to our library.

Typically the scans in our manuals are done as follows;

- 1) Typed text pages are typically scanned in black and white at 300 dpi.
- 2) Photo pages are typically scanned in gray scale mode at 600 dpi
- 3) Schematic diagram pages are typically scanned in black and white at 600 dpi unless the original manual had colored high lighting (as is the case for some 70's vintage Tektronix manuals).
- 4) Most manuals are text searchable
- 5) All manuals are fully bookmarked

All data is guaranteed for life (yours or mine ... which ever is shorter). If for ANY REASON your file becomes corrupted, deleted or lost, Artek Media will replace the file for the price of shipping, or free via FTP download.

Thanks

Dave & Lynn Henderson
Artek Media



WARRANTY

All TEKTRONIX instruments are warranted against defective materials and workmanship for one year. Any questions with respect to the warranty should be taken up with your TEKTRONIX Field Engineer or representative.

All requests for repair and replacement parts should be directed to the TEKTRONIX Field Office or representative in your area. This will assure you the fastest possible service. Please include the instrument Type Number or Part Number and Serial Number with all requests for parts or service.

Specifications and price change privileges reserved.

Copyright © 1973 by Tektronix, Inc., Beaverton, Oregon. Printed in the United States of America. All rights reserved. Contents of this publication may not be reproduced in any form without permission of Tektronix, Inc.

U.S.A. and Foreign TEKTRONIX products covered by U.S. and foreign patents and/or patents pending.

TEKTRONIX is a registered trademark of Tektronix, Inc.

TABLE OF CONTENTS

SECTION 1	7D12 OPERATING INSTRUCTIONS	Page
	PRELIMINARY INFORMATION	
	7D12 Features	1-1
	Display Modes	1-2
	7D12 Installation	1-2
	Module Features	1-3
	M1 Multifunction Module	1-3
	M2 Sample/Hold Module	1-3
	M3 RMS Volts Module	1-3
	Module Installation	1-3
	7D12 SPECIFICATION	
	Electrical Characteristics	1-3
	Physical Characteristics	1-4
	Environmental Characteristics	1-4
SECTION 2	M1 OPERATING INSTRUCTIONS	
	PRELIMINARY INFORMATION	
	M1 Features	2-1
	Installation	2-1
	Digital Readout Display	2-1
	OPERATING CHECKOUT	2-1
	General	2-1
	Preliminary Instructions	2-2
	Digital Display Check	2-2
	Resistance	2-3
	DC Voltage	2-3
	Temperature	2-3
	GENERAL OPERATING INSTRUCTIONS	
	Resistance Measurements	2-4
	DC Voltage Measurements	2-4
	Temperature Measurements	2-5
	Using a Transistor as a Temperature-Sensing Device	2-5
	M1 SPECIFICATION	
	Electrical Characteristics	2-6
	Physical Characteristics	2-7
	Environmental Characteristics	2-7
SECTION 3	M2 OPERATING INSTRUCTIONS	
	PRELIMINARY INFORMATION	
	M2 Features	3-1
	Installation	3-1
	Display	3-1

TABLE OF CONTENTS (cont)

SECTION 3	M2 OPERATING INSTRUCTIONS (cont)	Page
	OPERATING CHECKOUT	3-1
	General	3-1
	Preliminary Instructions	3-1
	Digital and Analog Display	3-2
	S ₁ Measurement Mode	3-3
	S ₂ -S ₁ Measurement Mode	3-4
	GENERAL OPERATING INFORMATION	3-4
	Signal Connections	3-4
	Measurement Modes	3-5
	AC Coupling	3-5
	M2 OPERATION USING P6055 PROBE	
	General	3-5
	Operator Probe Adjustments	3-5
	Equipment Required	3-5
	Adjustment Procedure	3-6
	M2 SPECIFICATION	3-7
	Electrical Characteristics	3-8
	Physical Characteristics	3-11
	Environmental Characteristics	3-11
SECTION 4	M3 OPERATING INSTRUCTIONS	
	PRELIMINARY INFORMATION	
	M3 Features	4-1
	Installation	4-1
	Display	4-1
	OPERATING CHECKOUT	4-1
	General	4-1
	Preliminary Instructions	4-2
	Digital Display Check	4-2
	RMS Voltage	4-3
	M3 SPECIFICATION	
	Electrical Characteristics	4-4
	Physical Characteristics	4-5
	Environmental Characteristics	4-5
SECTION 5	OPTIONS	
	M1 Options	5-1
	M2 Options	5-1
	CHANGE INFORMATION	

LIST OF ILLUSTRATIONS

Figure Number		Page
1-1	7D12 A/D Converter with M1 Multifunction Module partially installed, M2 Sample/Hold Module, and M3 RMS Volts Module. (Frontispiece)	
1-2	7D12 Front-Panel Control and Connector Functions.	1-1
1-3	Display Mode switch location and function.	1-2
1-4	7D12 and Module installation.	1-2
2-1	M1 MODE/RANGE control and front-panel connectors.	2-2
2-2	Schematic diagram of temperature-sensing transistor connected to probe connector.	2-6
3-1	M2 Front-panel control and connector functions.	3-2
3-2	S ₁ Mode display and readout (DC coupled).	3-4
3-3	S ₂ -S ₁ Mode display and readout.	3-4
3-4	Amplitude measurement of a square wave 1.4 milliseconds after the step function.	3-5
3-5	Percentage of signal decay in AC COUPLING mode.	3-6
3-6	P6055 probe low frequency compensation point.	3-7
4-1	M3 Front-panel control and connector functions.	4-2
4-2	Analog waveform and digital displays.	4-3

LIST OF TABLES

Table Number		
1-1	7D12 Electrical Characteristics	1-3
1-2	Physical Characteristics	1-4
1-3	Environmental Characteristics	1-4
2-1	M1 Electrical Characteristics	2-6
2-2	Physical Characteristics	2-7
2-3	Environmental Characteristics	2-7
3-1	M2 Vertical Display Sensitivity	3-1
3-2	Electrical Characteristics	3-8
3-3	Physical Characteristics	3-11
3-4	Environmental Characteristics	3-11
4-1	M3 Vertical Display Sensitivity	4-1
4-2	Electrical Characteristics	4-4
4-3	Physical Characteristics	4-5
4-4	Environmental Characteristics	4-5

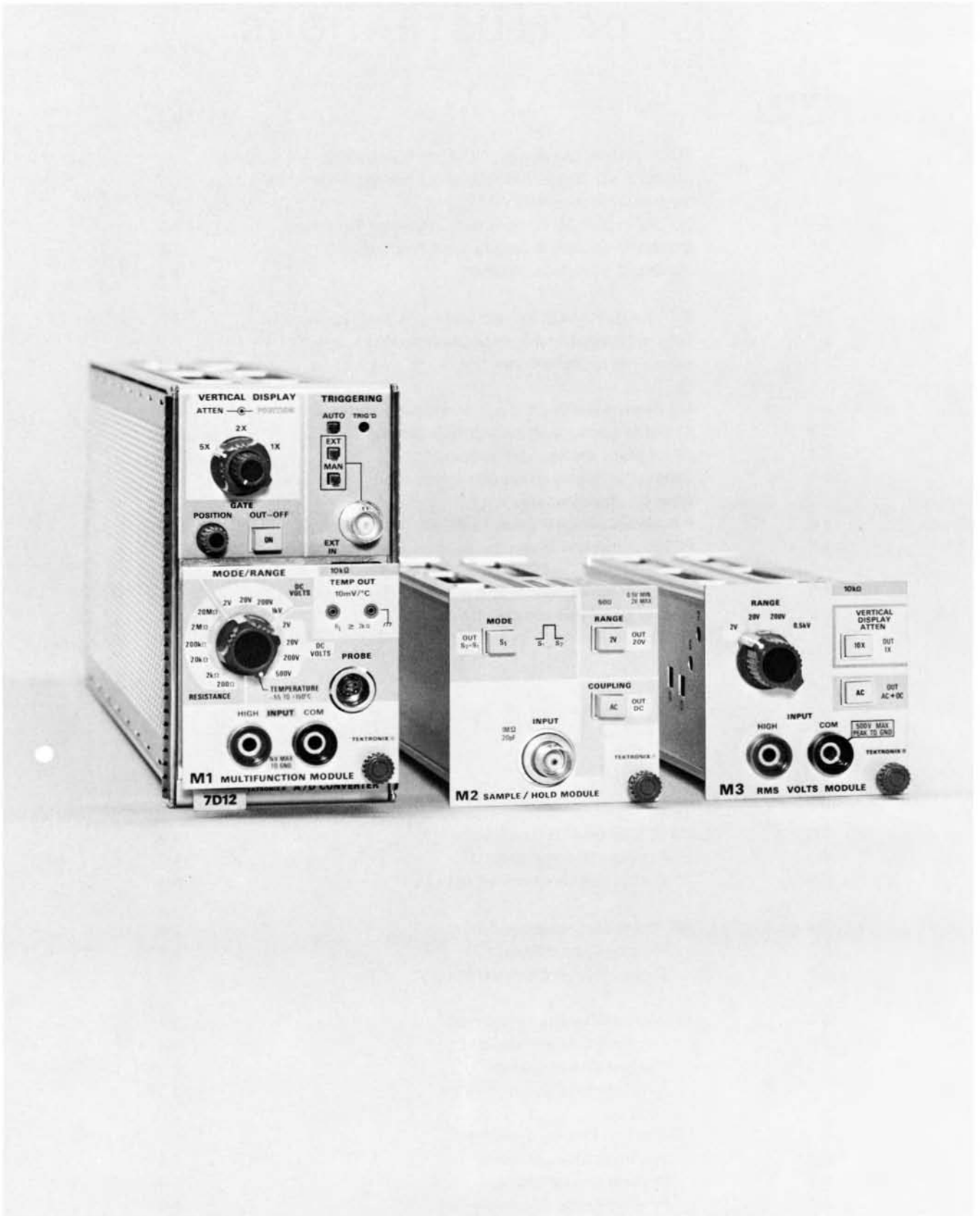

Fig. 1-1. 7D12 A/D Converter with M1 Multifunction Module Partially Installed, M2 Sample/Hold Module, and M3 RMS Volts Module.

7D12

OPERATING INSTRUCTIONS

PRELIMINARY INFORMATION

7D12 Features

The 7D12 is an analog to digital converter for use with any 7000-series oscilloscope mainframe that contains read-out. Several plug-in modules are available for use with the 7D12. Depending upon the plug-in module used, the 7D12 can supply up to a 4-1/2 digit display with a full scale reading of 20000 on the mainframe CRT. When not used, the most significant digit of the display is suppressed. Automatic polarity and overflow indicators are also contained in the 7D12. The A/D Converter can be triggered

internally by the plug-in module, manually by a front-panel switch, or externally from a trigger source such as the 7D15 Period Timer. The 7D12 also contains a vertical display amplifier that displays the signal applied to the module, and a gate display amplifier that displays a representation of the 7D12 internal gate signal.

Since the 7D12 function is dictated by the module installed, instructions for operating the 7D12 are located in the Operating Instructions for each module (i.e., M1, M2, or M3). A brief description of the 7D12 Front-Panel Controls and Connectors is shown in Fig. 1-2.

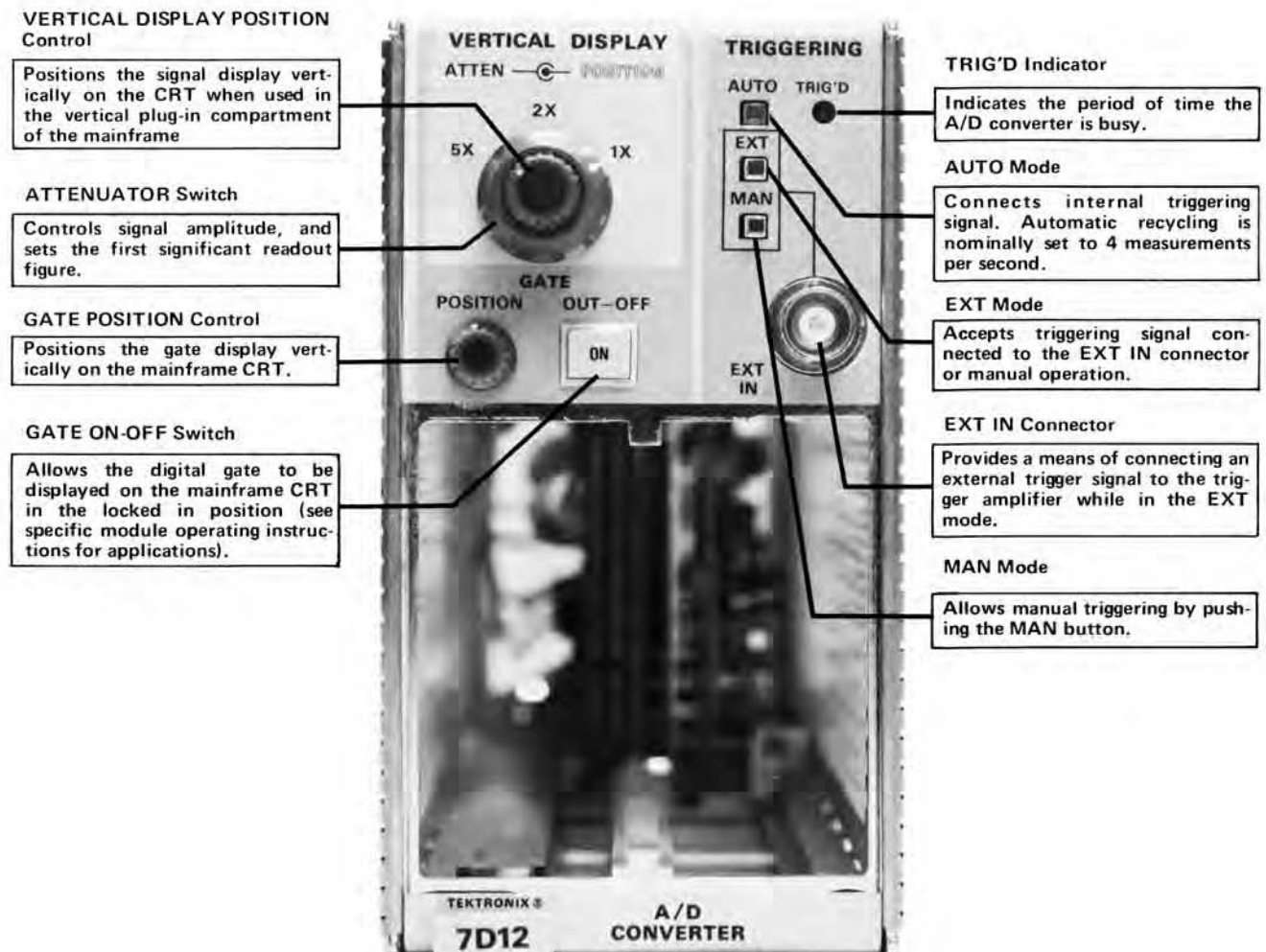

Fig. 1-2. 7D12 Front-panel control and connector functions.

Display Modes

The vertical display and the internal gate display can be operated in either alternate or chop mode, depending upon the internal Display Mode switch setting; see Fig. 1-3.

Alternate Mode. The Alt position (toward front panel) of the Display Mode switch produces a display that alternates between the vertical display and the gate display with each sweep on the CRT. Although the Alt mode can be used at all sweep rates, the Chop mode provides a more satisfactory display at sweep rates below about 0.2 millisecond per division. At slow sweep rates, alternate mode switching becomes visually perceptible.

Chop Mode. The Chop position (toward rear) of the Display Mode switch produces a display that is electronically switched between the input display and the trigger gate display at approximately a 500 kilohertz rate (controlled by mainframe). In general, the Chop mode provides the best display at sweep rates slower than about 0.2 millisecond per division.

7D12 Installation

CAUTION

Extreme care should be exercised when handling the 7D12 to prevent touching any part of the circuit boards. This unit contains several high impedance circuits which can develop inter-leakage if contaminated by body salts or acids.

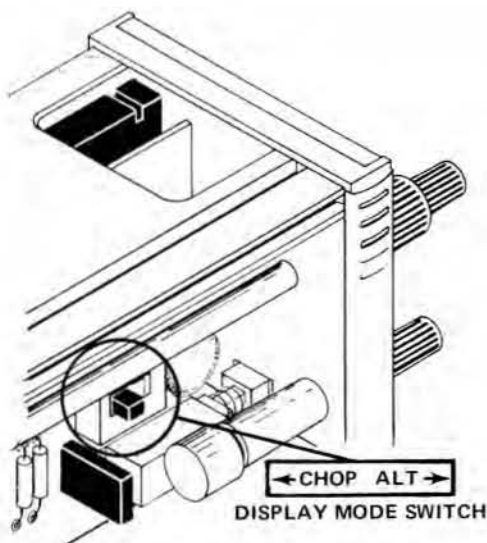

Fig. 1-3. Display mode switch location and functions.

CAUTION

Avoid the use of chemical cleaning agents which might damage the plastics used in this instrument. Avoid chemicals that contain benzene, toluene, acetone or similar solvents. Recommended cleaning agents are isopropyl alcohol or Kelite (1 part Kelite, 20 parts water).

The 7D12 is calibrated and ready for use with a module as received. It can be installed in any compartment of Tektronix 7000-series oscilloscopes, but is intended principally for use in vertical plug-in compartments. To install, align the upper and lower rails of the 7D12 with the oscilloscope tracks and fully insert it. The front is flush with the front of the oscilloscope when the 7D12 is fully inserted, and the latch at the bottom-left corner of the 7D12 will be in place against the front-panel. See Fig. 1-4.

Set the oscilloscope for a vertical mode to correspond with the vertical compartment used when an analog signal is to be displayed. The digital readout will be displayed regardless of the vertical mode selected.

To remove the 7D12, pull on the latch (which is inscribed with the unit identification "7D12") and the

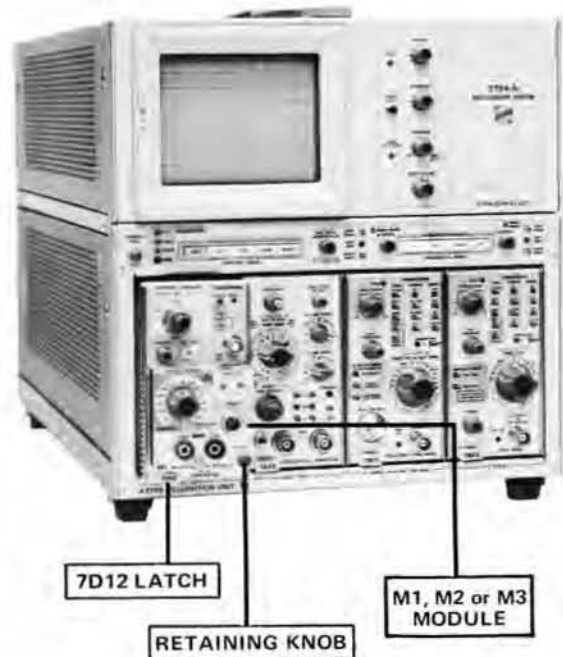

Fig. 1-4. 7D12 and module installation.

7D12 will unlatch. Continue pulling on the latch to slide the 7D12 out of the oscilloscope.

Module Features

M1 Multifunction Module. The M1 Module is shown partially installed in the 7D12. The M1 is capable of measuring resistance, DC volts, and temperature. The floating INPUT allows up to 1,000 volts elevation from ground, with a 10 megohm input impedance on the DC scale. The input to the M1 is presented as a digital readout on the CRT of the associated oscilloscope, along with information encoded by other plug-in units.

M2 Sample/Hold Module. The M2 Module is designed to measure the voltage amplitude or the difference voltage between any two points of a waveform connected to the INPUT connector. Two separate analog displays are presented on the mainframe CRT; the signal waveform to be measured that is connected to the M2 INPUT, and the trigger signal connected to the 7D12 EXT IN connector. The point of measurement on the waveform coincides with the trigger signal transition point. The input to the M2 is presented as a digital readout within the upper division of the CRT viewing area, and the vertical sensitivity is presented directly below in the lower division of the CRT

viewing area. A Tektronix P6055 probe, which is equipped with a readout coding ring, can be used with the M2 Module to extend its range. The readout coding ring on the probe connects to a circuit in the A/D Converter unit that automatically corrects the readout displayed on the CRT to the actual deflection factor at the probe tip.

M3 RMS Volts Module. The M3 Module converts the input signal to a DC equivalent of the true RMS value of that signal, in either AC or DC coupling. The input signal is displayed on the mainframe CRT, and the RMS readout is presented in the upper division of the CRT viewing area. The vertical sensitivity readout is presented directly below, in the lower division of the CRT viewing area.

Module Installation

All modules are calibrated and ready for use with the 7D12 as received. To install, align the upper and lower rails of the module with the 7D12 module-compartment tracks and fully insert it. The front is flush with the front of the 7D12 when the module is fully inserted. Lock the module securely in position by rotating the retaining knob clockwise until it is finger-tight. (See Fig. 1-4.) To remove the module, reverse the above procedure.

7D12 SPECIFICATION

Limits and tolerances given in the Supplemental Information column are provided for user information only and should not be interpreted as Performance Requirements. Other 7D12 characteristics are included in the module Specification Tables.

TABLE 1-1

Electrical Characteristics

Characteristic	Performance Requirement	Supplemental Information
Input Characteristics		
Accuracy	See Module Specifications, M1, Table 2-1; M2, Table 3-1; M3, Table 4-2	
Measurement Rate		
Auto Trigger		Approximately 4 measurements per second, internally adjustable (with R441) down to approximately 1 measurement per second. The adjustable range can be increased up to 12 measurements per second by changing the value of R407.

TABLE 1-1 (cont)

Characteristic	Performance Requirement	Supplemental Information
External Trigger (Input Frequency vs Measurement Rate)		Input Frequency: <u>1. Less than approximately 1 hertz.</u> a. Measurement rate equal to input frequency. <u>2. Approximately 1 hertz to approximately 12 hertz.</u> a. Measurement rate is equal to the input frequency. b. Internally adjustable (with R441) down to approximately 1 measurement per second. <u>3. Greater than approximately 12 hertz.</u> a. Measurement rate at least 12 measurements per second. b. Internally adjustable (with R441) down to approximately 1 measurement per second.
Input Signal Integration Period		20 milliseconds: 1 megahertz crystal 16 milliseconds: 1.25 megahertz crystal
VERTICAL DISPLAY ATTEN Range		X1, X2, and X5. Correct sensitivity is provided by scale factor readout.
External Trigger Input Impedance		50 Ω or 10 Ω, depending on module used; M1, 10 kΩ, M2, 50 Ω, M3, 10 kΩ

TABLE 1-2

Physical Characteristics

Size	Fits all 7000-series plug-in compartments
Weight	2.2 Pounds (0.992 Kilogram)

TABLE 1-3

Environmental Characteristics

Refer to the specification for the associated mainframe

M1

OPERATING INSTRUCTIONS

PRELIMINARY INFORMATION

M1 Features

The M1 Multifunction Module operates with the 7D12 A/D Converter unit and the readout system of a Tektronix 7000-series oscilloscope to provide the capability to measure DC voltage, resistance, and temperature. The floating INPUT allows up to 1,000 volts elevation from ground, with a 10 megohm input impedance on the DC volts scale. Test leads can be used with the RESISTANCE or DC VOLTS ranges, and a probe may be used with the DC VOLTS or TEMPERATURE ranges. Front-panel pin connectors are provided to drive external analog temperature indicators.

Installation

CAUTION

Extreme care should be exercised when handling the M1 to prevent touching any part of the circuit boards, especially the portion of the Main board which extends beyond the metal framework of the module. This unit contains several high impedance circuits which can develop inter-leakage if contaminated by body salts or acids.

CAUTION

Avoid the use of chemical cleaning agents which might damage the plastics used in this instrument. Avoid chemicals which contain benzene, toluene, xylene, acetone or similar solvents. Recommended cleaning agents are isopropyl alcohol or Kelite (1 part Kelite, 20 parts water).

The M1 is designed to operate in the 7D12 A/D Converter unit, which can be installed in any plug-in compartment of Tektronix 7000-series oscilloscopes. Fig. 1-4 shows installation of the 7D12 and module.

Digital Readout Display

The output from the M1 Multifunction Module is a DC analog voltage. The 7D12 converts the analog voltage to a digital readout displayed on the CRT of the mainframe.

Information encoded from other plug-in units is also displayed on the CRT. This display is written by the CRT beam on a time-shared basis with the waveform display from the other plug-in units.

The digital readout display for the M1 will appear in the top division of the CRT in a location corresponding to the plug-in compartment used. There is no analog output signal presented on the CRT; therefore, it is not necessary to select the 7D12 and M1 with the oscilloscope Vertical or Horizontal Mode switches.

The digital readout display ranges from 0000 to 20000, with a > symbol for over-ranging. The measurement units and decimal position in the display are determined by the MODE/RANGE switch setting. When the input exceeds the measurement range in use, the symbol > is displayed in place of the polarity symbol.

OPERATING CHECKOUT

General

When shipped from the factory, the M1 has been calibrated to meet the Specifications listed in the M1 Specification section and is ready to be used with a 7D12 A/D Converter and a readout-equipped Tektronix 7000-series oscilloscope.

Steps 1 through 21 of the following procedure provide an operational check to verify satisfactory operation of the module, 7D12, and the associated oscilloscope. This portion of the procedure is intended as a quick functional check only and should be performed each time the M1 and 7D12 are placed in a different oscilloscope.

The remainder of this procedure demonstrates the basic operation of the MODE/RANGE control and the front-panel connectors; see Fig. 2-1. It is recommended that the entire procedure be followed completely for familiarization with the instrument. Operation of the oscilloscope is described in the oscilloscope instruction manual.

The tolerances given for the digital readout are for units being operated in an ambient temperature range of +15°C to +40°C. For operation outside of these limits, refer to the M1 Specification section.

13. The readout should be within the limits of 0.000 k Ω to 0.001 k Ω .

14. Set the MODE/RANGE control to RESISTANCE/200 k Ω .

15. The readout should be within the limits of 00.00 k Ω to 00.01 k Ω .

16. Set the MODE/RANGE control to RESISTANCE/2 M Ω .

17. The readout should be within the limits of .0000 M Ω to .0001 M Ω .

18. Set the MODE/RANGE control to RESISTANCE/20 M Ω .

19. The readout should be within the limits of 0.000 M Ω to 0.001 M Ω .

20. Remove the banana-plug patch cord connecting the INPUT connectors together.

21. The readout display (M1/7D12 only) will display a > symbol and will indicate a high value of resistance. The unit is attempting to measure the resistance between the INPUT connectors. Since this value exceeds the 20 M Ω range, the display indicates the symbol > for over-ranging.

This concludes the operational check procedure.

Resistance

22. Connect a pair of test leads to the INPUT connectors.

23. Connect a 10 k Ω resistor between the test leads. (The value of the resistor is not critical for this demonstration.)

24. The readout display will read the value of the resistor used. Set the MODE/RANGE switch to RESISTANCE/2 M Ω , RESISTANCE/200 k Ω and RESISTANCE/20 k Ω and notice that the reading changes to include more significant figures.

25. Set the MODE/RANGE control to RESISTANCE/2 k Ω and observe that the > symbol appears to indicate over-ranging.

DC Voltage

26. Remove the resistor from the test leads, and connect the COM test lead to the oscilloscope ground post.

27. Set the oscilloscope Calibrator 4 V and the Rate (Calibrator) switch to DC.

28. Set the MODE/RANGE switch to DC VOLTS/20 V.

29. Touch the HIGH test lead to the oscilloscope Calibrator output.

30. The readout will read about +4.000 V (the exact reading will depend upon the accuracy of the oscilloscope calibrator).

31. Reverse the test lead connections; i.e., connect the HIGH test lead to the ground post and the COM test lead to the calibrator output.

32. The readout should read the same value of voltage as in step 30 but with a - polarity indicated.

Temperature

33. Connect a voltage/temperature probe such as the P6058 to the M1 Probe connector (see M1 Options at the end of this section). Observe the precautions relating to proper alignment of the connectors as given in the Probe instruction manual.

34. Set the MODE/RANGE control to TEMPERATURE.

35. The readout should read the room temperature within the limits listed in Table 2-1 of the M1 Specification section. (Alternate Procedure: Place the probe in an environment having a known temperature.)

36. Connect the INPUT connectors to the TEMP OUT pin jack connectors with the test leads. The COM connector should be connected to the right hand TEMP OUT connector (ground).

M1 Operating Instructions—7D12 Operators

37. Set the MODE/RANGE control to DC VOLTS/2 V.

38. The readout display will read out a voltage corresponding to 10 mV per each degree Celsius of the temperature reading obtained in step 35 within 0.1%. For example, if the reading obtained in step 35 was +25°C, the reading obtained in this step should be 10 mV X +25 equals 250 mV or +.250 V.

39. Disconnect the test leads and the voltage/temperature probe. This completes the Operating Checkout Procedure.

GENERAL OPERATING INSTRUCTIONS

Resistance Measurements



Care should be exercised when measuring resistance in circuitry containing low current—high frequency solid state devices. Depending on the M1 resistance range selected, currents of up to approximately 10 mA or voltages of up to approximately 6 volts may appear at the resistance measurement terminals.

The M1 measures resistance in six full-scale ranges as follows: 00.00 to 200.00 Ω ; .0000 to 2.0000 k Ω ; 0.000 to 20.000 k Ω ; 00.00 to 200.00 k Ω ; .0000 to 2.0000 M Ω ; 0.000 to 20.000 M Ω . To operate the M1 as an ohmmeter, proceed as follows:

1. Insert the M1 Module into the 7D12 A/D Converter and install in any available plug-in compartment of a 7000-series oscilloscope.

2. Turn the oscilloscope power on and allow twenty minutes warmup.

3. Set the oscilloscope readout to obtain a usable readout display (if necessary, refer to the oscilloscope instruction manual).

4. Set the MODE/RANGE control to the desired RESISTANCE range.

5. Connect the INPUT connectors to the resistance to be measured using the supplied test lead set.

DC Voltage Measurements

The M1 can measure DC voltages up to 1 kV in four full-scale ranges as follows: ± 0.0000 to ± 2.0000 V; ± 0.000 to ± 20.000 V; ± 00.00 to ± 200.00 V; and ± 0.0000 to ± 1.0000 kV.

The voltage to be measured can be connected to the M1 via the INPUT connectors or a compatible probe connected to the PROBE connector. Observe the Maximum Safe Input Voltage limits given in Table 2-1 in the M1 Specification section for all measurements.

To measure DC voltages via the INPUT connectors, use the following procedure:

1. Insert the M1 Module into the 7D12 A/D Converter and install in any available plug-in compartment of a 7000-series oscilloscope.

2. Turn the oscilloscope power on and allow about twenty minutes warmup.

3. Advance the oscilloscope Readout control to obtain a usable readout display (if necessary, refer to the oscilloscope instruction manual).

4. Select the desired full-scale voltage range with the MODE/RANGE switch. (The ranges to be used with measurements made via the INPUT connectors are indicated by the orange tint of the front panel.)

5. Connect the voltage to be measured to the INPUT connectors. The readout will display a "+" preceding the reading if the HIGH input terminal is positive with respect to the COM terminal, and "-" if the HIGH terminal is negative with respect to the COM terminal.

To measure DC voltages with the probe, use the following procedure:

(See M1 Options in Section 5).

1. Insert the M1 Module into the 7D12 A/D Converter and install in any available plug-in compartment of a 7000-series oscilloscope.

2. Turn the oscilloscope power on and allow about twenty minutes warmup.

3. Advance the oscilloscope Readout control to obtain a usable readout display (refer to the oscilloscope instruction manual if necessary).

4. Select the desired full-scale voltage range by setting the MODE/RANGE control to one of the four DC VOLTS ranges with the gray front-panel background.

5. Connect a compatible probe such as the P6058 to the M1 PROBE connector.



When connecting the probe to the PROBE connector, the two connectors must be correctly aligned. Damage to the terminals can result from forcing the connector and jack together. Refer to the probe instruction manual.

6. Apply the voltage to be measured between the probe tip and the common strap on the probe. Do not use the COM INPUT connector when making a measurement with the probe.

7. The readout will display a "+" preceding the voltage reading if the probe tip is positive with respect to the common strap, and "-" if the probe tip is negative with respect to the common strap.

Voltage measurements with the probe are essentially the same as with test leads. The probe is a straight-through device; i.e., it provides no attenuation to extend the measurement range. The probe is shielded to minimize pickup of electrostatic interference. (For more information, see the instruction manual for the probe.)

Temperature Measurements

The M1, in conjunction with a temperature sensing probe such as the P6058, can measure temperatures from -55°C to +150°C in one range. (See M1 Options in Section 5).

To measure temperature, use the following procedure:

1. Insert the M1 Module into the 7D12 A/D Converter and install in any available plug-in compartment of a 7000-series oscilloscope.

2. Turn the oscilloscope power on and allow twenty minutes warmup.

3. Advance the oscilloscope Readout control to obtain a usable readout display (if necessary, refer to the oscilloscope instruction manual).

4. Connect the temperature-sensing probe to the front-panel PROBE connector.



When connecting the temperature probe to the PROBE connector, the two connectors must be correctly aligned. Damage to the terminals can result from forcing the connector and jack together. Refer to the probe instruction manual.

5. Set the MODE/RANGE switch to TEMPERATURE.

6. Apply the probe sensor tip to the device being measured. For optimum temperature transfer, the surface of the device being measured should be coated with silicon grease and the probe tip should be applied squarely to the surface.

7. Allow a sufficient amount of time for the probe tip to "settle" before taking a reading. The time required depends upon several factors. Generally, when the tip is first applied to the device-under-test, the readings will change rapidly. As the probe tip temperature approaches the temperature of the device-under-test, the reading will stabilize or "settle".

Using a Transistor as a Temperature-Sensing Device

Certain NPN transistors such as a 2N2484 can be used as a separate sensor in place of the probe tip with little or no selection of the device.

Typical accuracy, without recalibration of the M1, can be expected to be within 1°C for measurements from -55°C to +125°C. However, device parameters could vary, causing inaccuracies in the temperature readout as great as ±5°C.

If the measurement to be made requires an accuracy greater than ±5°C, the calibration should be checked.

M1 Operating Instructions/Specification—7D12 Operators

Check the calibration by placing the sensing device in an environment having a known ambient temperature, and comparing the readout versus known temperature. Any difference noted at the test temperature can be used as a correction factor throughout the measurement range of -55°C to $+125^{\circ}\text{C}$.

The temperature-sensing transistor is connected to the M1 through the front-panel PROBE connector using two-conductor shielded cable and a connector plug (Tektronix Part Number 131-0778-00). A wiring diagram is shown in Fig. 2-2.

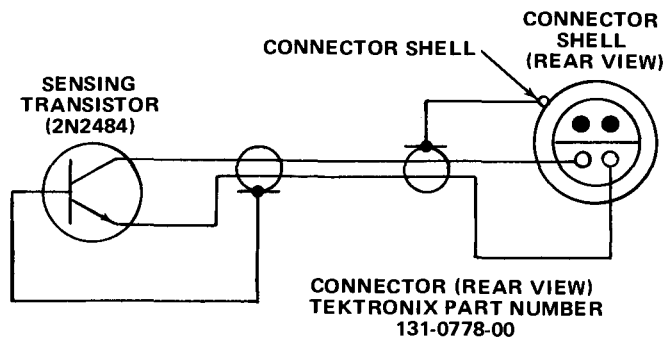

Fig. 2-2. Schematic diagram of temperature-sensing transistor connected to probe connector.

M1 SPECIFICATION

The electrical characteristics listed in Table 2-1 are valid over the stated environmental range for instruments calibrated at an ambient temperature of $+20^{\circ}\text{C}$ to $+30^{\circ}\text{C}$, and after a 20 minute warmup unless otherwise noted. Limits and tolerances given in the Supplemental Information column are provided for user information only and should not be interpreted as Performance Requirements.

TABLE 2-1

Electrical Characteristics

Characteristic	Performance Requirement	Supplemental Information
DC VOLTS		
Range	0 to 1000 volts	Four full-scale ranges of $\pm 2.0000\text{ V}$, $\pm 20.000\text{ V}$, $\pm 200.00\text{ V}$, and $\pm 1.0000\text{ kV}$.
Accuracy (with 7D12)		
+15°C to +40°C	$\pm 0.04\%$ of reading, $\pm 0.005\%$ of full scale.	
+20°C to +30°C	$\pm 0.03\%$ of reading, $\pm 0.005\%$ of full scale.	
Polarity		Automatic selection and display.
Input Resistance		10 M Ω within 1% on all ranges.
Maximum Non-Destructive Input Voltage		1000 volt peak between INPUT connectors. 1000 volt peak between either connector and chassis or unit ground.
Common Mode Rejection Ratio		80 dB at 60 Hz. (Using 100 Ω unbalance in either HIGH or COM INPUT connectors.)
Normal Mode Rejection Ratio		50 dB at 60 Hz.
RESISTANCE		
Range	0 to 20 M Ω	Six full-scale ranges of 200.00 Ω , 2.0000 k Ω , 20.000 k Ω , 200.00 k Ω , 2.0000 M Ω , and 20.000 M Ω .

TABLE 2-1 (cont)

Characteristic	Performance Requirement	Supplemental Information
Accuracy (with 7D12) +15°C to +40°C	±0.09% of reading, ±0.01% of full scale.	
Overload Protection		Limited by 60 mA fuse. (Will withstand 20 volts at INPUT terminals.)
Reference Current Magnitude (Amperes)		$\frac{2 \text{ V}}{\text{Full-Scale Resistance (ohms)}}$
Maximum Voltage Applied to Resistance Under Test		6 volts.
TEMPERATURE		
Range	-55°C to +150°C in one range.	
Accuracy (with P6058 Probe using black probe tip 206-0186-01 or 206-0186-02) 7D12 and M1 Ambient Temperature Range +15°C to +40°C	Within 1°C, -55°C to +125°C. Within 2°C, +125°C to +150°C.	
TEMP OUT 10 mV/°C		
Accuracy	Within 10 mV.	Load impedance must not be less than 2 kΩ.
DIGITAL DISPLAY		
DC Volts Mode and Resistance Mode		4-1/2 digits of display.
Temperature Mode		-55.0°C to +150°C.
MEASUREMENT		
Setting Time		Less than 2.5 seconds to within 1 count of final reading.

TABLE 2-2

Physical Characteristics

Size	Fits the 7D12 A/D Converter only
Weight	12 Ounces (0.340 Kilogram)

TABLE 2-3

Environmental Characteristics

Refer to the specification for the associated Mainframe.
(See Table 2-1 for exceptions.)

M2

OPERATING INSTRUCTIONS

PRELIMINARY INFORMATION

M2 Features

The M2 Sample/Hold Module operates with the 7D12 A/D Converter unit and a Tektronix 7000-series oscilloscope. The M2 provides the capability to measure voltage or difference voltage at any point in time. The voltage measurement MODE and RANGE are front-panel controlled, and the INPUT signal can be AC or DC coupled.

This section describes the operation of the front-panel controls, giving first time and general operating information.

Installation

The M2 is designed to operate in the 7D12 A/D Converter, which can be installed in any vertical plug-in compartment of Tektronix 7000-series oscilloscopes equipped with readout. See module installation, Fig. 1-4.

Display

The output from the M2 Sample/Hold Module is a DC analog voltage. The 7D12 converts the analog signal to a digital readout display that is presented on the mainframe CRT. The input and trigger waveforms can also be presented on the mainframe CRT from the 7D12 vertical amplifier section. A digital readout of the measured voltage appears in the upper graticule division and the vertical sensitivity is displayed directly below in the lower graticule division. The readout and waveform displays are written by the CRT beam along with the readout and waveforms from other plug-in units on a time-shared basis. Since there is an analog output signal presented on the CRT, it is necessary to select the 7D12 and M2 vertical compartment with the oscilloscope Vertical Mode switch. The voltage measurement is accomplished by connecting an external trigger signal to the 7D12 external trigger input. The point of measurement on the displayed input signal coincides with the transition point of the displayed trigger gate signal.

The voltage readout display ranges from 000 to 2000 with a > symbol for over-ranging. The measurement units and decimal positions are determined by the M2 RANGE switch setting. The 7D12 VERTICAL DISPLAY ATTEN switch sets the first significant figure of the vertical sensitivity readout display.

OPERATING CHECKOUT

General

When shipped from the factory, the M2 has been calibrated to meet the specifications listed in Table 3-2 and is ready to be used with a 7D12 A/D Converter and a readout-equipped Tektronix 7000-series Oscilloscope.

Steps 1 through 30 of the following procedure provide an operational check to verify satisfactory operation of the unit and the associated oscilloscope. This portion of the procedure is intended as a quick functional check only and should be performed each time the M2 and 7D12 is placed in a different oscilloscope.

The remainder of the procedure demonstrates the basic operation of the M2 MODE, RANGE, and COUPLING switches. See the M2 front panel control and connector functions, Fig. 3-1. It is recommended that the entire procedure be followed completely for familiarization with the instrument. Operation of the oscilloscope is described in the oscilloscope instruction manual.

Vertical display sensitivity in relation to various control settings are shown in Table 3-1. The tolerances given for the digital readout are for units being operated in an ambient temperature range of +15°C to +40°C.

TABLE 3-1
Vertical Display Sensitivity

M2 RANGE	7D12 VERTICAL DISPLAY ATTEN (Volts/Division)		
	1X	2X	5X
2 V	100 mV	200 mV	500 mV
20 V	1 V	2 V	5 V

Preliminary Instructions

1. Set the 7D12 internal Display Mode switch to the Chop position. See Fig. 1-3.
2. Insert the M2 Module into the 7D12 A/D Converter and install them in a vertical compartment of a 7000-series oscilloscope.

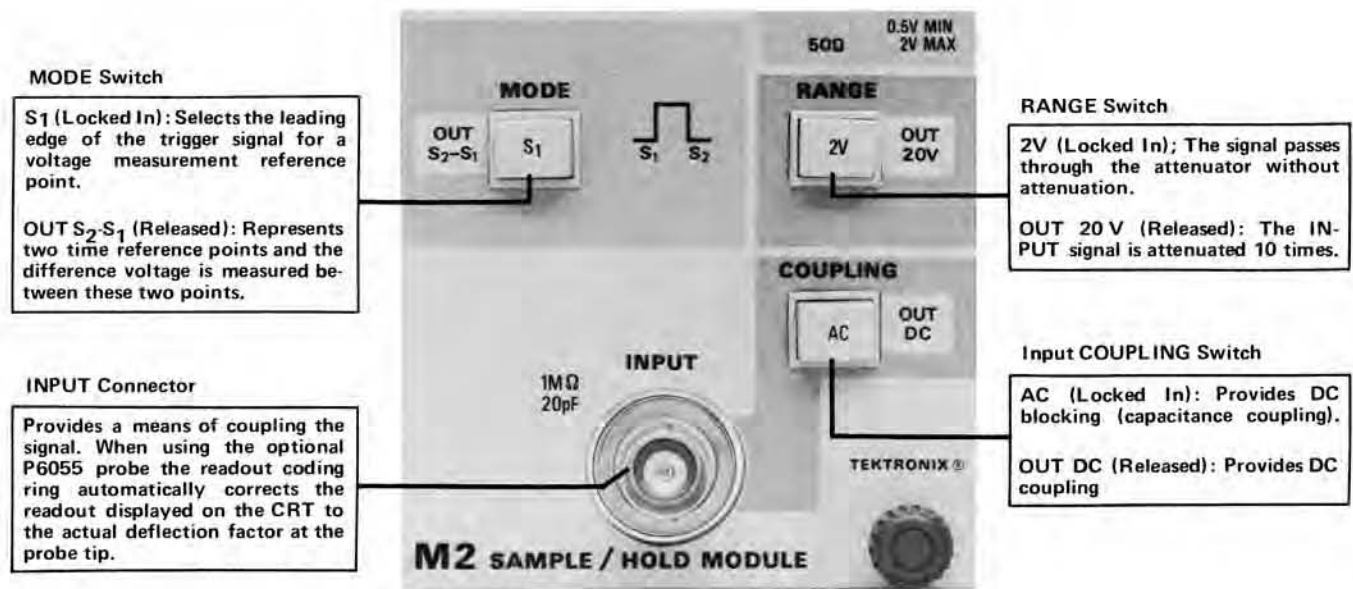

Fig. 3-1. M2 Front-panel control and connector functions.

3. Install a dual time-base unit, or two time-base units capable of delaying-delayed sweep operation, in the oscilloscope.

4. Connect the oscilloscope to a power source which meets the voltage and frequency requirements of the oscilloscope power supply.

5. Turn the oscilloscope power on and allow about twenty minutes warmup time.

6. During the warmup period, set the controls as follows:

7D12

VERTICAL DISPLAY
 ATTEN 1X
 GATE OUT-OFF
 TRIGGERING AUTO

M2

MODE S₁
 RANGE OUT 20 V
 COUPLING OUT DC

7. Set the oscilloscope and delaying time-base for normal operation at a sweep rate of 100 microseconds per division. The M2 measurement readout display should appear in the upper graticule division, and the vertical sensitivity readout (in volts per division) should appear in the lower graticule division in a location corresponding to the plug-in compartment used.

Digital and Analog Display

8. Connect a shorting-type BNC connector cover (Tektronix Part 200-0991-00) or similar device to the M2 INPUT connector.

9. The measurement readout should read within the limits of ± 0.00 V to ± 0.01 V, and the sensitivity readout should read 1 V.

10. Set the M2 RANGE to 2 V.

11. The measurement readout should read within the limits of ± 0.00 V to ± 0.001 V, and the sensitivity readout should read 100 mV.

12. Set the 7D12 VERTICAL DISPLAY ATTEN to 2X.

13. The measurement readout should remain unchanged and the sensitivity readout should read 200 mV.

14. Set the M2 RANGE to OUT 20 V.

15. The measurement readout should read within the limits of ± 0.00 V to ± 0.01 V, and the sensitivity readout should read 2 V.

16. Set the 7D12 VERTICAL DISPLAY ATTEN to 5X.

17. The measurement readout should remain unchanged and the sensitivity readout should read 5 V.

18. Set the M2 RANGE to 2 V.

19. The measurement readout should read within the limits of ± 0.000 V to ± 0.001 V, and the sensitivity readout should read 500 mV.

20. Rotate the 7D12 VERTICAL DISPLAY POSITION control fully clockwise and fully counterclockwise. Check that the vertical display trace can be positioned throughout the graticule area. Position the trace to the center horizontal graticule line.

21. Set the 7D12 GATE to ON.

22. Rotate the 7D12 GATE POSITION control fully counterclockwise and clockwise. Check that the gate trace can be positioned throughout the graticule area. Position the gate trace three divisions below the center horizontal graticule line.

23. Check that the 7D12 TRIG'D indicator is flashing.

24. Set the 7D12 TRIGGERING to EXT.

25. The TRIG'D indicator light should be extinguished.

26. Push the MAN button and note that the TRIG'D indicator light flashes one time.

27. Set the delaying time-base sweep rate to 50 milliseconds per division. The vertical display trace and the gate trace should start at the same time.

28. Set the 7D12 internal Display Mode switch (see Fig. 1-3) to the Alt position. The vertical display trace and the gate trace should be displayed alternately with each sweep on the CRT.

29. Return the 7D12 internal Display Mode switch to the Chop position.

30. Remove the shorting-type BNC connector cover from the M2 INPUT connector.

This concludes the operational check procedure.

S₁ Measurement Mode

31. Set the delaying time-base for delaying sweep operation with a delay time of 300 microseconds.

32. Set the delayed time-base for a sweep rate of 100 microseconds per division.

33. Set the oscilloscope and time-base to display an intensified trace.

34. Set the 7D12 VERTICAL DISPLAY ATTEN to 2X, and the M2 RANGE to OUT 20 V.

35. Connect a 4-volt square wave from the oscilloscope calibrator output to the M2 INPUT connector.

36. Connect the oscilloscope or time-base delayed-sweep-gate output to the 7D12 TRIGGERING EXT IN connector. Refer to the oscilloscope and time-base instruction manuals for the location of the delayed-sweep-gate output.

37. Adjust the delaying time-base to trigger on the negative slope.

38. Adjust the 7D12 VERTICAL DISPLAY POSITION control to center the square-wave baseline on the center horizontal graticule line.

39. Position the gate waveform below the vertical display waveform with the 7D12 GATE POSITION control.

40. The readout should read approximately 0.00 V. See Fig. 3-2A.

M2 Operating Instructions—7D12 Operators

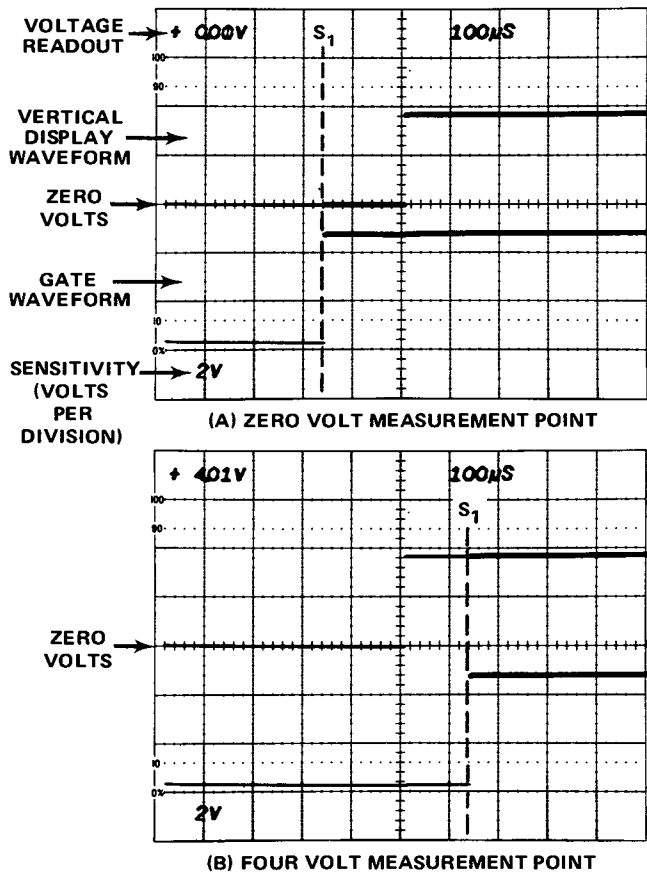

Fig. 3-2. S_1 Mode Display and Readout (DC Coupled).

41. Adjust the time-base delay-time multiplier to position the S_1 measurement point directly under the positive portion of the square wave.

42. The readout should read approximately +4.00 V. See Fig. 3-2B.

S_2 - S_1 Measurement Mode

43. Use the same setup procedure as described previously under S_1 Measurement Mode, step 31.

44. Set the delaying time-base sweep rate to 200 microseconds per division.

45. Set the MODE switch to OUT S_2 - S_1 , and the COUPLING switch to OUT DC.

46. Adjust the delay-time multiplier to position the S_1 measurement point directly under the vertical display waveform zero-volt level.

47. Adjust the time-base sweep rate to position the S_2 measurement point directly under the vertical-display waveform four-volt level.

48. The readout should read approximately +4.00 V (the difference voltage between the S_1 and S_2 measurement points). See Fig. 3-3A.

49. Adjust the delay-time multiplier to position the S_1 and S_2 measurement points as shown in Fig. 3-3B.

50. The readout voltage should read approximately -400 V.

GENERAL OPERATING INFORMATION

Signal Connections

M2 INPUT. In general, 50-ohm coaxial cables offer a convenient means of connecting signals to the M2 INPUT; however, the vertical sensitivity can be extended by a factor of 10 by using the P6055 probe. See M2 Operation Using P6055 Probe.

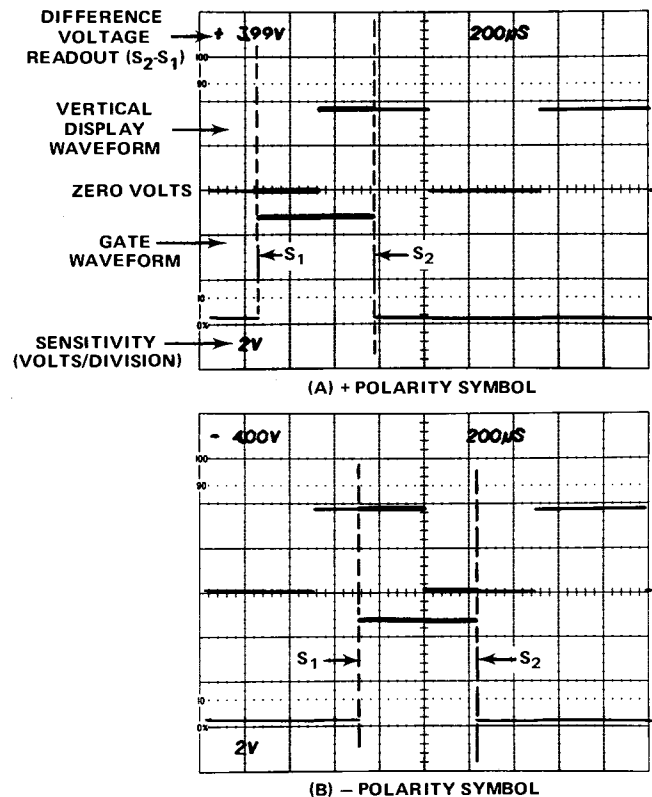

Fig. 3-3. S_2 - S_1 Mode Display and Readout.

7D12 EXT IN. 50-ohm coaxial cables offer the most convenient means of connecting trigger signals to the 7D12 EXT IN connector. If the intended trigger signal has an amplitude greater than 2 volts, a 50-ohm attenuator should be used. Any attenuation ratio (or combination of attenuation ratios) that will provide an amplitude of 0.5 volt minimum to 2 volts maximum can be used.

Measurement Modes

S₁ Mode. The M2 provides direct amplitude measurement (with reference to ground) of signals up to 25 MHz. The point of measurement on the displayed input signal coincides with the leading transition point of the displayed gate waveform.

S₂—S₁ Mode. The M2 provides difference amplitude measurement (between S₁ and S₂ measurement points) of signals up to 25 MHz. The S₂ measurement point coincides with the trailing edge of the displayed gate waveform.

AC Coupling

Low repetition-rate signals applied to the M2 are integrated when using the AC COUPLING mode. Fig. 3-4 shows the percentage of signal decay with relation to time. The readout, in the AC-coupled mode, must be interpolated to obtain an accurate voltage measurement.

The AC COUPLING mode eliminates the DC component of the displayed waveform. A perfectly symmetrical waveform will center itself on zero volts, with equal positive- and negative-going excursions. However, since all

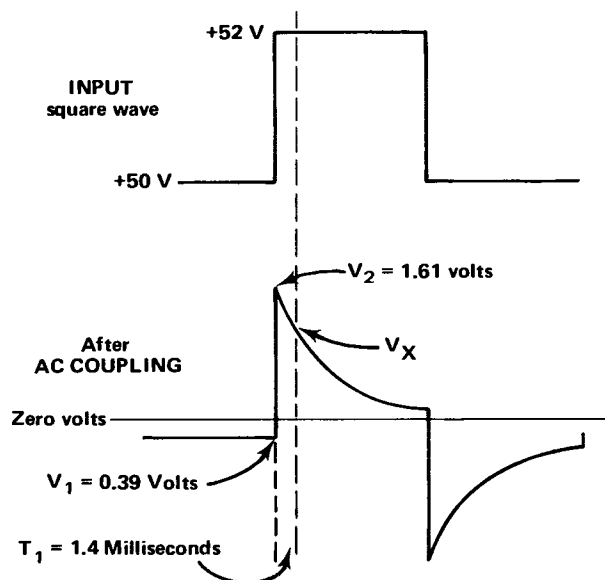

Fig. 3-4. Amplitude measurement of a square wave 1.4 milliseconds after the step function.

waveforms are not symmetrical, three measurements must be made to determine the accurate voltage at any selected point in time.

Example: Measurement of the voltage amplitude 1.4 milliseconds after the step function of a square wave elevated 50 volts above ground. Refer to Fig. 3-4.

For this example assume the input square wave is perfectly flat, and the voltage readout at V_x is +1.94 V, with reference to V₁.

1. Measure the voltage at V₁, V₂, and the desired measurement point V_x.

2. The graph in Fig. 3-5 shows the signal decays three percent in 1.4 milliseconds after the step function.

3. Add the absolute values of V₁ and V₂ to determine the peak-to-peak voltage. (1.61 V plus 0.39 V = 2.00 volts)

4. The AC voltage decay in 1.4 milliseconds will be 2.00 volts times three percent. (0.06 volts)

5. The corrected readout voltage at point V_x should be V_x (+1.94 V) plus 0.06 volts = +2.00 volts.

M2 OPERATION USING P6055 PROBE

General

The P6055 is a low-capacitance miniature probe with a DC attenuation ratio that is adjustable to an exact 10X ratio. The probe input characteristics and the readout coding ring feature provide accurate measurements with 10X attenuation when used with the M2 module. The measurement accuracy may not be reliable if another kind of probe is used. For this reason, the P6055 probe is recommended for use with the M2.

The P6055 must be adjusted and checked with the M2 as outlined below. For probe specifications and maintenance refer to the P6055 probe Instruction Manual.

Operator Probe Adjustments

Equipment Required. The following equipment is required to adjust the P6055 probe for use with the M2.

1. Square-wave generator: Repetition rate, 1 kilohertz; risetime, less than 120 nanoseconds; amplitude, greater

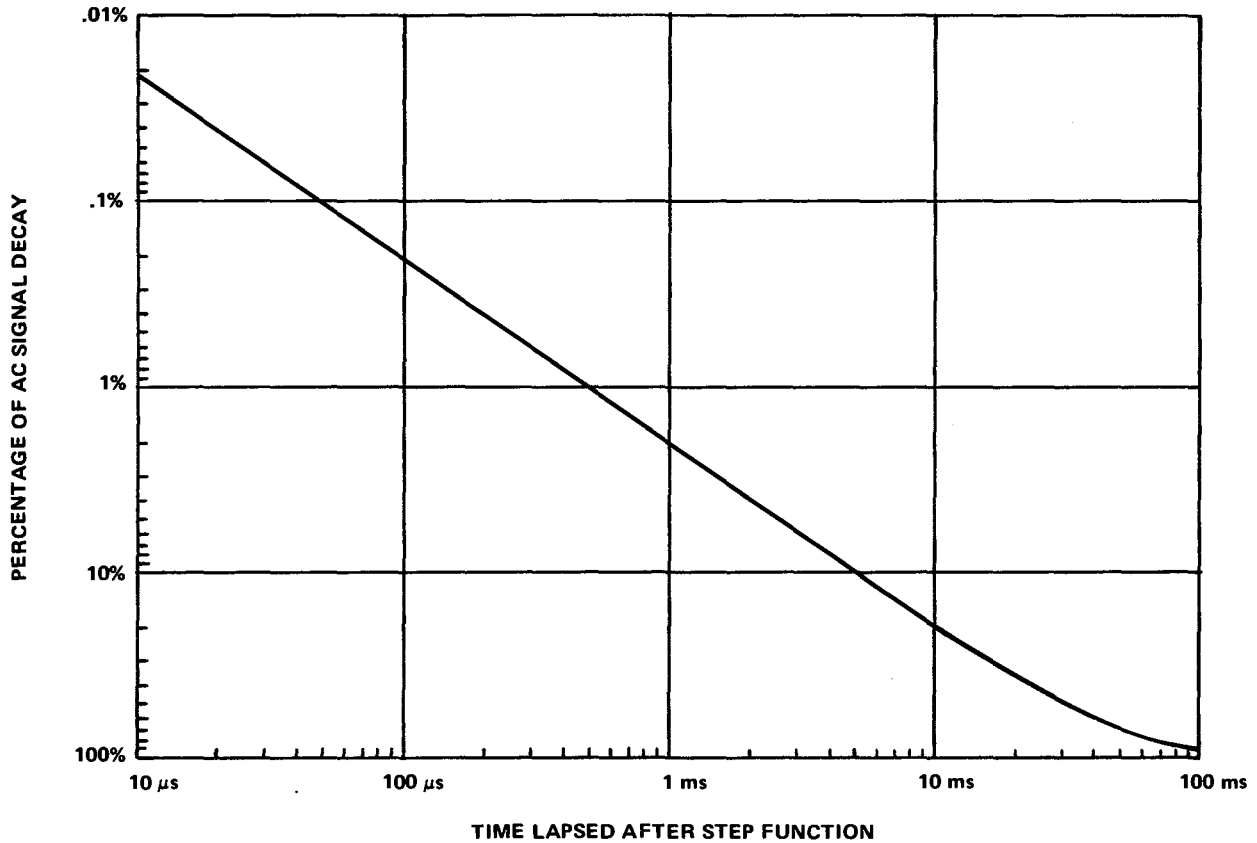

Fig. 3-5. Percentage of signal decay in AC COUPLING mode.

than 20 volts; pulse top flatness, within 0.5% after 750 nanoseconds; negative-going square-wave referenced to zero volts.

Recommended equipment: Tektronix Type 106 Square-wave Generator.

2. Precision DC voltage supply: Output, 20 volts DC; accuracy, within 0.05%; ripple, less than 1 millivolt.

Recommended equipment: Fluke 343A DVM Calibrator.

Adjustment Procedure

1. Insert the M2 Module into the 7D12 A/D Converter and install in the left vertical compartment of a 7000-series oscilloscope.

2. Install a delaying time-base in the A Horizontal compartment and a time-base into the B Horizontal

compartment of the oscilloscope. (One dual time-base such as the 7B53A can be substituted in place of the two time-bases.)

3. Connect the oscilloscope to a power source that meets the voltage and frequency requirements of the oscilloscope power supply.

4. Turn the oscilloscope power on and allow about twenty minutes warmup time.

5. During the warmup period, set the controls as follows.

- | | |
|---------------------|------------------|
| Oscilloscope | |
| A Intensity | Counterclockwise |
| Vertical Mode | Left |
| Horizontal Mode | A |
| A Trigger Source | Vert Mode |

7D12

VERTICAL DISPLAY	
ATTEN	5X
GATE DISPLAY	OUT-OFF
TRIGGERING	AUTO

M2

MODE	S ₁
RANGE	2 V
COUPLING	OUT DC

6. Set the time-bases to start the delayed sweep after the delay time.

7. Set the delaying time-base sweep rate to 100 microseconds per division.

8. Advance the oscilloscope readout and intensity controls to obtain a usable readout and intensified sweep display on the CRT.

9. Connect the P6055 probe to the M2 INPUT connector. The vertical sensitivity readout display should change from 500 mV to 5 V.

10. Set the P6055 probe Hf Term adjustment for maximum resistance. (fully counterclockwise.)

11. Connect the probe tip to a 20 volt DC voltage source.

12. Adjust the probe Dc Atten adjustment for a voltage readout display of +20.00 V on the CRT.

13. Remove the probe from the DC voltage source.

14. Connect the oscilloscope delayed sweep + gate to the 7D12 TRIGGERING EXT IN connector.

15. Set the 7D12 TRIGGERING to EXT and the GATE to ON.

16. Connect the P6055 probe directly to a one kilohertz square-wave generator.

17. Adjust the square-wave generator to display approximately 20 volts (4 divisions) of signal on the CRT.

18. Set the delaying time-base sweep rate to 100 nanoseconds per division.

19. Adjust the Delay Time Multiplier control to position the S₁ measurement point 750 nanoseconds after the square-wave step function begins. See Fig. 3-6.

20. Adjust the P6055 probe Lf Comp (located on the probe body) for a voltage readout display of 0.00 V.

21. Remove the probe from the square-wave generator.

This concludes the probe adjustment procedure.

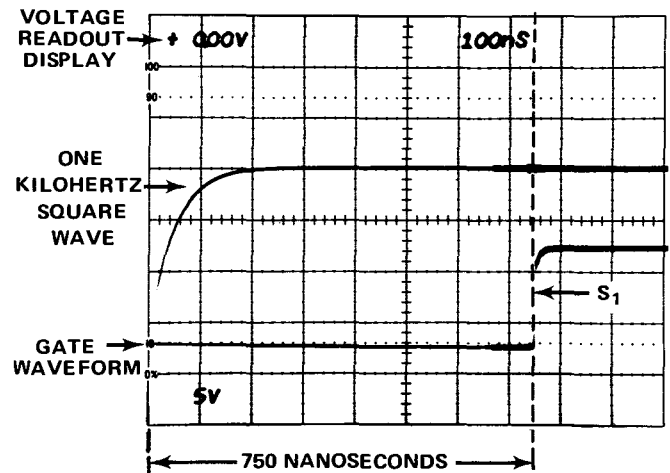

Fig. 3-6. P6055 Probe low frequency compensation point.

M2 SPECIFICATION

The electrical characteristics listed in Table 3-2 are valid over the stated environmental range for instruments calibrated at an ambient temperature of +20°C to +30°C, and after a 20 minute warmup unless otherwise noted.

Limits and tolerances given in the Supplemental Information column are provided for user information only and should not be interpreted as Performance Requirements.

TABLE 3-2
Electrical Characteristics

Characteristic	Performance Requirement	Supplemental Information
Vertical Display		
Trigger Gate (7D12)		
Amplitude		2 divisions, within 20 percent
Risetime		Equal to or less than 5 nanoseconds
Falltime		Equal to or less than 5 nanoseconds
Vertical Input (M2)		
Frequency Response		
Bandwidth DC Coupled (Direct Coupled)	DC to at least 25 MHz at -3 dB	
Lower Bandwidth (AC Coupled) (Capacitive Coupled)	3.39 Hz or less at -3 dB	
Resistance		1 megohm, within 0.05%
Capacitance		20 picofarads, within 5%
Maximum Non-Destruct Input Voltage		100 volts peak
Normal Operating Voltage		Equal to or less than 1.25 times RANGE switch setting
Sensitivity (7D12 and M2)	Six steps in a 1, 2, 5 sequence from 100 millivolts per division to 5 volts per division	Selected by combination settings of the M2 RANGE and 7D12 VERTICAL DISPLAY ATTEN switches
Gain Accuracy	0 volts to 20 volts	
Digital Readout		
Measurement Range (Referenced to ground)	0 volts to 20 volts	Selected in two ranges of: ±0.00 V to ±2.00 V, and ±0.00 V to ±20.00 V
Display		3-1/2 digits
Legend on channel 2		Vertical display sensitivity
Measurement Sampling		
Aperture Time		10 nanoseconds or less
Pulse Width (S₁ to S₂)		
Repetitive	5 milliseconds maximum	30 nanoseconds minimum
Single-Shot	150 microseconds minimum	

TABLE 3-2 (cont)

Characteristic	Performance Requirement	Supplemental Information
External Triggering Input		
Operating Pulse Amplitude		
Logic '0'	Equal to or less than 0 volts	
Logic '1'	Equal to or greater than +0.5 volts	
Maximum Pulse Amplitude	±2 volts	
Impedance		50 ohms, plus or minus 5 percent
Maximum Non-Destruct Voltage		Plus or minus 5 volts
Risetime		50 nanoseconds or less
Falltime		50 nanoseconds or less
Repetition Rate		Equal to or less than 1 MHz
Measurement Rate		
External		Variable from 1 to 12 measurements per second with 7D12 internal adjustment R441. Auto lockout provided.
Manual (S ₁ Mode only)		Manual operation
Auto (S ₁ Mode only)		Variable from 1 to 4 measurements per second with 7D12 internal adjustment R441.
Accuracy (without P6055 probe)		Accuracy test conditions:
40 nanoseconds After the Input Transition		INPUT step function and voltage levels.
(+20°C to +30°C ambient)		Zero Volts
Mode		-2 Volts
S ₁	Within 0.15 percent of the peak-to-peak INPUT voltage, ±0.1% of the reading, ±2 counts, ± percentage of AC decay	+2 Volts
S ₂ -S ₁	Within 0.25 percent of the peak-to-peak INPUT voltage, ±0.15% of the reading, ±2 counts, ± percentage of AC decay.	Zero Volts
		Risetime and falltime equal to or less than 10 nanoseconds
		Sampled points (S ₁ or S ₂ -S ₁).
		

TABLE 3-2 (cont)

Characteristic	Performance Requirement	Supplemental Information
(+15°C to +40°C ambient) Mode S ₁ S ₂ —S ₁	Within 0.25 percent of the peak-to-peak INPUT voltage, ±0.2% of the reading, ±3 counts, ± percentage of AC decay Within 0.35 percent of the peak-to-peak INPUT voltage, ±0.25% of the reading, ±3 counts, ± percentage of AC decay	
Accuracy (with P6055 Probe) (+20°C to +30°C) Mode S ₁ 40 to 500 nanoseconds 500 nanoseconds to ∞ S ₂ —S ₁ 40 to 500 nanoseconds 500 nanoseconds to ∞	Within 0.8% of the peak-to-peak INPUT voltage, ±0.15% of the reading, ±2 counts, ± the percentage of AC decay. Within 0.2% of the peak-to-peak INPUT voltage, ±0.15% of the reading, ±2 counts, ± the percentage of the AC decay. Within 1% of the peak-to-peak INPUT voltage, ±0.2% of the reading, ±2 counts, ± the percentage of AC decay. Within 0.3% of the peak-to-peak INPUT voltage, ±0.2% of the reading, ±2 counts, ± the percentage of AC decay.	
(+15°C to +40°C) Mode S ₁ 40 to 500 nanoseconds 500 nanoseconds to ∞ S ₂ —S ₁ 40 to 500 nanoseconds 500 nanoseconds to ∞	Within 1% of the peak-to-peak INPUT voltage, ±0.25% of the reading, ±3 counts, ± the percentage of AC decay. Within 0.3% of the peak-to-peak INPUT voltage, ±0.25% of the reading, ±3 counts, ± the percentage of AC decay. Within 1% of the peak-to-peak INPUT voltage, ±0.3% of the reading, ±3 counts, ± the percentage of AC decay. Within 0.4% of the peak-to-peak INPUT voltage, ±0.3% of the reading, ±3 counts, ± the percentage of AC decay.	

TABLE 3-2 (cont)

Characteristic	Performance Requirement	Supplemental Information
<p>Low frequency AC Coupling Effect</p>		 <p>Input waveform</p> <p>Displayed waveform</p> <p>% AC decay</p> <p>t</p> <p>Percent of AC decay = $(1 - e^{-2\pi \cdot 3.39t}) \times 100\%$</p> <p>Example</p> <p>t = 48 microseconds</p> <p>Percent of AC decay = $\pm 0.1\%$</p>

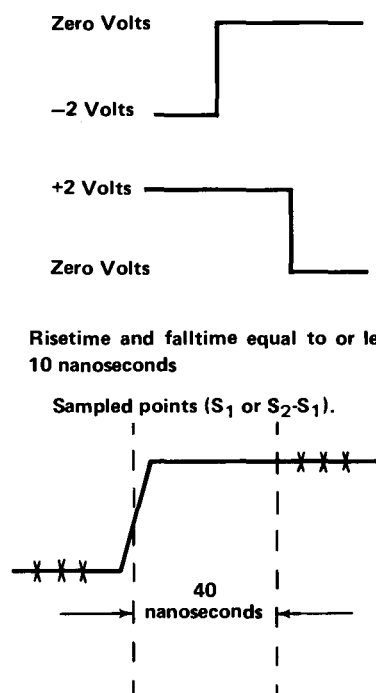
TABLE 3-3

Physical Characteristics

Size	Fits the 7D12 A/D Converter only
Weight	13.5 ounces (.382 Kilogram)

TABLE 3-4

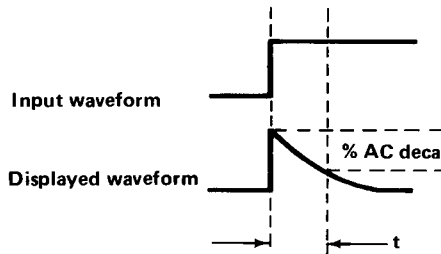
Environmental Characteristics

Refer to the specifications for the associated mainframe. (See Table 3-2 for exceptions.)

M3

OPERATING INSTRUCTIONS

PRELIMINARY INFORMATION

M3 Features

The M3 RMS Volts Module operates with the 7D12 A/D Converter unit and a Tektronix 7000-series oscilloscope equipped with readout. The M3 provides the capability to measure the true RMS value of any DC or alternating voltage (see Frequency Response in Table 4-2) with a crest factor of less than five. Floating INPUT terminals that allow up to 500 volts peak to ground are used to couple the AC analog signal to the M3. The 7D12 converts the scaled DC equivalent of the AC analog signal into a digital readout to be displayed on the mainframe CRT. The M3 input waveform can also be displayed on the mainframe CRT.

To effectively use the M3, the operation and capabilities of the instrument should be known. This section describes the operation of the front-panel controls, giving first-time and general operating information.

Installation

The M3 is designed to operate in the 7D12 A/D Converter, which can be installed in any vertical plug-in compartment of Tektronix 7000-series oscilloscopes. See module installation, Fig. 1-4.

Display

The output from the M3 RMS Module is a DC analog voltage. The 7D12 converts the analog voltage to a digital readout display presented on the mainframe CRT. The input waveform can also be presented on the mainframe CRT from the 7D12 vertical amplifier section. The 7D12 readout and waveform displays are written by the CRT beam along with the readout and waveforms from other plug-in units on a time-shared basis.

The digital readout display for the M3 will appear in the top division of the CRT, and the vertical sensitivity in volts per division will appear in the bottom division of the CRT in a location corresponding to the plug-in compartment used. Since there is an analog output signal presented on the CRT it is necessary to select the 7D12 and M3 with the oscilloscope Vertical Mode switch.

The RMS readout display ranges from 000 to 2000 with a > symbol for over-ranging. The measurement units and decimal positions are determined by the M3 RANGE switch setting. The 7D12 VERTICAL DISPLAY ATTEN switch sets the first significant figure of the vertical sensitivity readout display.

OPERATING CHECKOUT

General

When shipped from the factory, the M3 has been calibrated to meet the specifications listed in Table 4-2 and is ready to be used with a 7D12 A/D Converter and a readout-equipped Tektronix 7000-series oscilloscope.

Steps 1 through 28 of the following procedure provide an operational check to verify satisfactory operation of the unit and the associated oscilloscope. This portion of the procedure is intended as a quick functional check only and should be performed each time the M3 and 7D12 is placed in a different oscilloscope.

The remainder of the procedure demonstrates the basic operation of the M3 RANGE control, VERTICAL DISPLAY ATTEN, and Coupling switches, and the 7D12 VERTICAL DISPLAY ATTEN switch. See M3 front panel control and connector functions, Fig. 4-1. It is recommended that the entire procedure be followed completely for familiarization with the instrument. Operation of the oscilloscope is described in the oscilloscope instruction manual.

Vertical display sensitivity with relation to various control combinations is shown in Table 4-1. The tolerances given for the digital readout are for units being operated in an ambient temperature range of +15°C to +40°C. For operation outside these limits, refer to Table 4-2 in the Specification section.

TABLE 4-1

Vertical Display Sensitivity
(Volts/Division)

M3 Range	M3 Vertical Display Atten	7D12 Vertical Display Atten		
		1X	2X	5X
2 V	1X	100 mV	200 mV	500 mV
	10X	1000 mV	2000 mV	5000 mV
20 V	1X	1 V	2 V	5 V
	10X	10 V	20 V	50 V
200 V	1X	10 V	20 V	50 V
	10X	100 V	200 V	500 V
0.5 kV	1X	100 V	200 V	500 V
	10X	1000 V	2000 V	5000 V

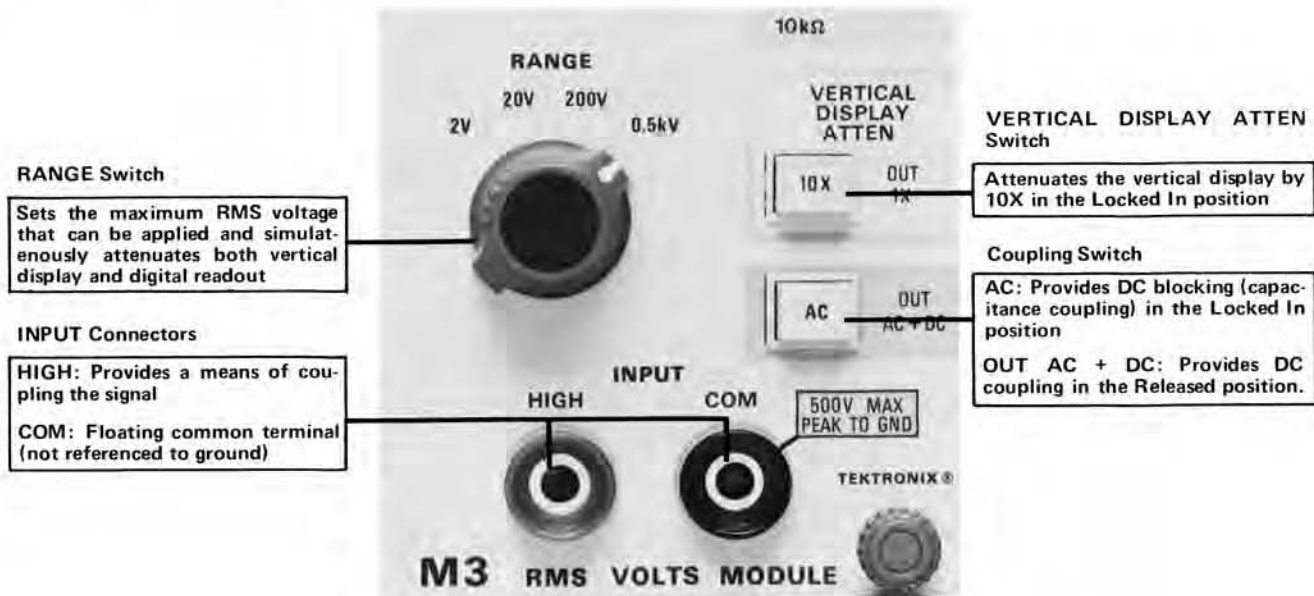

Fig. 4-1. M3 Front-panel control and connector functions.

Preliminary Instructions

1. Insert the M3 Module into the 7D12 A/D Converter and install in the left vertical compartment of a 7000-series oscilloscope.
2. Install a time-base in the A horizontal plug-in compartment of the oscilloscope.
3. Connect the oscilloscope to a power source that meets the voltage and frequency requirements of the oscilloscope power supply.
4. Turn the oscilloscope power on and allow about twenty minutes warmup time.
5. During the warmup period, set the controls as follows:

Oscilloscope

Intensity	Counterclockwise
Readout	Off
Vertical Mode	Left
Horizontal Mode	A

7D12

VERTICAL DISPLAY ATTEN	1X
GATE	OUT-OFF
TRIGGERING	AUTO

M3

RANGE	2 V
VERTICAL DISPLAY ATTEN	OUT 1X
Coupling	OUT AC+DC

Digital Display Check

6. Connect the M3 INPUT connectors together with a short banana-plug jumper.
7. Advance the oscilloscope Readout and Intensity controls to obtain a usable readout and sweep display on the CRT. The M3 readout display (RMS voltage) should appear in the upper graticule division, and the vertical sensitivity in volts per division should appear in the lower graticule division.
8. The readout should read within the limits of .000 V to .001 V, and the vertical sensitivity should read 100 mV.
9. Set the M3 VERTICAL DISPLAY ATTEN to 10X.
10. The vertical sensitivity should read 1000 mV.
11. Set the RANGE switch to 20 V.
12. The readout should read within the limits of 0.00 V to 0.01 V, and the vertical sensitivity should read 10 V.

13. Set the M3 VERTICAL DISPLAY ATTEN to 1X.
14. The vertical sensitivity should read 1 V.
15. Set the RANGE switch to 200 V.
16. The readout should read within the limits of 00.0 V to 00.1 V, and the vertical sensitivity should read 10 V.
17. Set the M3 VERTICAL DISPLAY ATTEN to 10X.
18. The vertical sensitivity should read 100 V.
19. Set the RANGE switch to 0.5 kV.
20. The readout should read within the limits of .000 kV to .001 kV, and the vertical sensitivity should read 1000 V.

21. Set the M3 VERTICAL DISPLAY ATTEN to 1X.
22. The vertical sensitivity should read 100 V.
23. Set the 7D12 VERTICAL DISPLAY ATTEN to 2X.
24. The vertical sensitivity should read 200 V.
25. Set the 7D12 VERTICAL DISPLAY ATTEN to 5X.
26. The vertical sensitivity should read 500 V.

27. Rotate the 7D12 VERTICAL DISPLAY POSITION control full clockwise and full counterclockwise. Check that the horizontal trace can be positioned off the graticule area in both directions. Position the trace to the center horizontal graticule line.

28. Remove the banana-plug jumper connecting the INPUT connectors together.

This concludes the operational check procedure.

RMS Voltage

29. Connect the supplied test lead set to the INPUT connectors.

30. Set the controls as follows:

7D12	
VERTICAL DISPLAY	
ATTEN	1X

M3	
RANGE	20 V
VERTICAL DISPLAY	
ATTEN	OUT 1X
Coupling	OUT AC+DC

31. Connect a 4 volt calibrator signal from the oscilloscope to the INPUT connectors.

32. Set the time-base controls to obtain a triggered calibrator waveform display.

33. Check the amplitude of the calibrator waveform display for approximately four divisions. (Note that the calibrator waveform baseline is referenced to zero volts.) See Fig. 4-2A.

34. Check that the readout display is the RMS value of the input signal. ($0.707 \times E_{pk} = \text{RMS}$).

35. Set the M3 Coupling switch to AC.

36. The display should center itself on the CRT, and the loss of the DC factor should change the RMS readout display. ($1/2 E_{pk}$ to $E_{pk} = \text{RMS}$) See Fig. 4-2B.

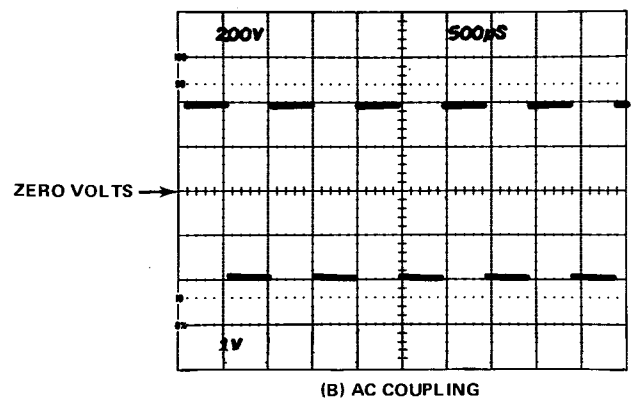
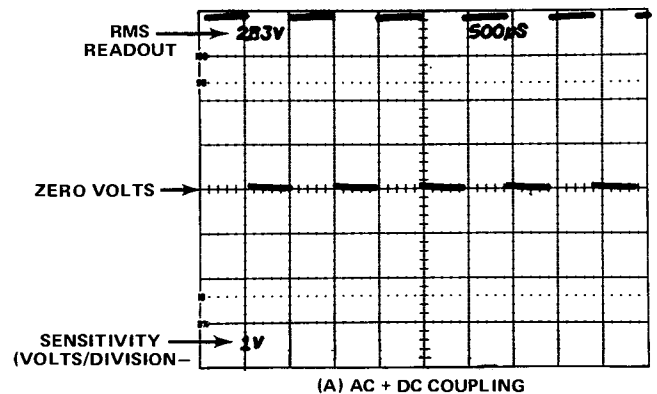

Fig. 4-2. Analog Waveform and Digital Displays.

M3 SPECIFICATION

The electrical characteristics listed in Table 4-2 are valid over the stated environmental range for instruments calibrated at an ambient temperature of +20°C to +30°C, and after a 20 minute warmup unless otherwise noted.

Limits and tolerances given in the Supplemental Information column are provided for user information only and should not be interpreted as Performance Requirements.

TABLE 4-2
Electrical Characteristics

Characteristic	Performance Requirement	Supplemental Information
Input		
Impedance		1 megohm, within 1%, shunted by 50 picofarads or less.
Crest Factor (maximum)		Five $\text{Crest Factor} = \frac{E_{pk}}{R_{RMS}}$
Peak Voltage (maximum)		2.5 times the RANGE setting, except 500 volt RMS range which is limited to 1,000 volts peak.
Maximum Non-Destruct Input Voltage (between INPUT connectors)		500 volts RMS 1000 volts peak
Maximum Non-Destruct Input Voltage (Between either INPUT connector and chassis ground)		500 volts peak
DC in AC Coupled Mode (Maximum)		200 volts
Digital System CMR (100 Ω Unbalance)		66 dB at DC to 60 Hz. Decreases 20 dB per decade for higher frequencies.
Digital Accuracy (M3 and 7D12 Combination) +15°C to +40°C Sine Wave Input Reading Greater than 5% of Full Scale.		Waveforms with form factors greater than 1.2 add: ± [0.1% X (form factor -1)] to the percentage of full scale accuracy specifications. $\text{Form Factor} = \frac{E_{RMS}}{E_{Average}}$
2 Volt and 20 Volt Ranges		
DC	±0.5% of full scale	
40 Hz to 40 kHz	±0.25% of full scale	
40 kHz to 100 kHz	±0.5% of full scale	
200 Volt Range		
DC	±0.5% of full scale	
40 Hz to 4 kHz	±0.25% of full scale	
4 kHz to 100 kHz	±0.5% of full scale; ±1% of reading	

TABLE 4-2 (cont)

Characteristic	Performance Requirement	Supplemental Information
500 Volt Range		
DC	± 1% of full scale	
40 Hz to 4 kHz	± 1% of full scale	
4 kHz to 100 kHz	± (2% of full scale plus 1% of reading)	
Digital Measurement		
RMS Readout Display Range	0 to 500 volts	Selected in four ranges of: .000 V to 2.000 V 0.00 V to 20.00 V 00.0 V to 200.0 V, and .000 V to .500 kV
Setting Time		250 milliseconds to 63% of final answer after step function from zero volts.
Display		3-1/2 digits of display
Legend on Channel 2		Vertical display sensitivity
Vertical Display		
(M3 and 7D12 Combination) Sensitivity (Vertical Display and Scale Factor Readout)	M3 VERTICAL DISPLAY ATTEN in 1X position provides twelve steps in a 1, 2, 5 sequence from 100 mV/division to 500 V/division.	Selected by combination settings of the M3 RANGE and 7D12 VERTICAL DISPLAY ATTEN switches.
	M3 VERTICAL DISPLAY ATTEN in 10X position reduces the vertical sensitivity by a factor of 10.	
Frequency Response	DC to 0.7 MHz at 3 dB down.	Slew rate limited to full scale voltage per microsecond (maximum 100 volts per microsecond).
Aberrations		Less than 5%
Gain Accuracy		Within 7%

TABLE 4-3

Physical Characteristics

Size	Fits the 7D12 A/D Converter only
Weight	12 Ounces (0.340 Kilogram)

TABLE 4-4

Environmental Characteristics

Refer to the specification for the associated Mainframe.
(See Table 4-2 for exceptions.)

OPTIONS

M1 OPTIONS

Option 2—Deletes the P6058 Voltage/Temperature probe package (010-0260-00).

M2 OPTIONS

Option 2—Deletes the P6055 3.5 ft. probe package (010-6055-01).

MANUAL CHANGE INFORMATION

At Tektronix, we continually strive to keep up with latest electronic developments by adding circuit and component improvements to our instruments as soon as they are developed and tested.

Sometimes, due to printing and shipping requirements, we can't get these changes immediately into printed manuals. Hence, your manual may contain new change information on following pages.

A single change may affect several sections. Since the change information sheets are carried in the manual until all changes are permanently entered, some duplication may occur. If no such change pages appear following this page, your manual is correct as printed.

SERVICE NOTE

Because of the universal parts procurement problem, some electrical parts in your instrument may be different from those described in the Replaceable Electrical Parts List. The parts used will in no way alter or compromise the performance or reliability of this instrument. They are installed when necessary to ensure prompt delivery to the customer. Order replacement parts from the Replaceable Electrical Parts List.

CALIBRATION TEST EQUIPMENT REPLACEMENT

Calibration Test Equipment Chart

This chart compares TM 500 product performance to that of older Tektronix equipment. Only those characteristics where significant specification differences occur, are listed. In some cases the new instrument may not be a total functional replacement. Additional support instrumentation may be needed or a change in calibration procedure may be necessary.

Comparison of Main Characteristics

DM 501 replaces 7D13		
PG 501 replaces 107	PG 501 - Risetime less than 3.5 ns into 50 Ω .	107 - Risetime less than 3.0 ns into 50 Ω .
108	PG 501 - 5 V output pulse; 3.5 ns Risetime.	108 - 10 V output pulse; 1 ns Risetime.
111	PG 501 - Risetime less than 3.5 ns; 8 ns Pretrigger pulse delay.	111 - Risetime 0.5 ns; 30 to 250 ns Pretrigger Pulse delay.
114	PG 501 - ± 5 V output.	114 - ± 10 V output. Short proof output.
115	PG 501 - Does not have Paired, Burst, Gated, or Delayed pulse mode; ± 5 V dc Offset. Has ± 5 V output.	115 - Paired, Burst, Gated, and Delayed pulse mode; ± 10 V output. Short-proof output.
PG 502 replaces 107		
108	PG 502 - 5 V output	108 - 10 V output.
111	PG 502 - Risetime less than 1 ns; 10 ns Pretrigger pulse delay.	111 - Risetime 0.5 ns; 30 to 250 ns Pretrigger pulse delay.
114	PG 502 - ± 5 V output	114 - ± 10 V output. Short proof output.
115	PG 502 - Does not have Paired, Burst, Gated, Delayed & Undelayed pulse mode; Has ± 5 V output.	115 - Paired, Burst, Gated, Delayed & Undelayed pulse mode; ± 10 V output. Short-proof output.
2101	PG 502 - Does not have Paired or Delayed pulse. Has ± 5 V output.	2101 - Paired and Delayed pulse; 10 V output.
PG 506 replaces 106	PG 506 - Positive-going trigger output signal at least 1 V; High Amplitude output, 60 V.	106 - Positive and Negative-going trigger output signal, 50 ns and 1 V; High Amplitude output, 100 V.
067-0502-01	PG 506 - Does not have chopped feature.	0502-01 - Comparator output can be alternately chopped to a reference voltage.
SG 503 replaces 190, 190A, 190B, 191, 067-0532-01	SG 503 - Amplitude range 5 mV to 5.5 V p-p. SG 503 - Frequency range 250 kHz to 250 MHz. SG 503 - Frequency range 250 kHz to 250 MHz.	190B - Amplitude range 40 mV to 10 V p-p. 191 - Frequency range 350 kHz to 100 MHz. 0532-01 - Frequency range 65 MHz to 500 MHz.
TG 501 replaces 180, 180A	TG 501 - Marker outputs, 5 sec to 1 ns. Sinewave available at 5, 2, and 1 ns. Trigger output - slaved to marker output from 5 sec through 100 ns. One time-mark can be generated at a time.	180A - Marker outputs, 5 sec to 1 μ s. Sinewave available at 20, 10, and 2 ns. Trigger pulses 1, 10, 100 Hz; 1, 10, and 100 kHz. Multiple time-marks can be generated simultaneously.
181	TG 501 - Marker outputs, 5 sec to 1 ns. Sinewave available at 5, 2, and 1 ns.	181 - Marker outputs, 1, 10, 100, 1000, and 10,000 μ s, plus 10 ns sinewave.
184	TG 501 - Marker outputs, 5 sec to 1 ns. Sinewave available at 5, 2, and 1 ns. Trigger output - slaved to marker output from 5 sec through 100 ns. One time-mark can be generated at a time.	184 - Marker outputs, 5 sec to 2 ns. Sinewave available at 50, 20, 10, 5, and 2 ns. Separate trigger pulses of 1 and .1 sec; 10, 1, and .1 ms; 10 and 1 μ s. Marker amplifier provides positive or negative time marks of 25 V min. Marker intervals of 1 and .1 sec; 10, 1, and .1 ms; 10 and 1 μ s.
2901	TG 501 - Marker outputs, 5 sec to 1 ns. Sinewave available at 5, 2, and 1 ns. Trigger output - slaved to marker output from 5 sec through 100 ns. One time-mark can be generated at a time.	2901 - Marker outputs, 5 sec to 0.1 μ s. Sinewave available to 50, 10, and 5 ns. Separate trigger pulses, from 5 sec to 0.1 μ s. Multiple time-marks can be generated simultaneously.

NOTE: All TM 500 generator outputs are short-proof. All TM 500 plug-in instruments require TM 500-Series Power Module.