

VISIBLE LIGHT PRODUCTS SPECIFICATION

HPR20D-19K10xWx



High Power 10W LED

Drawn by	Checked by	Approved by



DATE:2009/8/21

REV:B

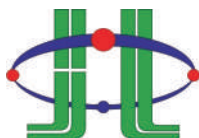

HUEY JANN ELECTRONICS INDUSTRY CO., LTD.

No.27 Line 466 Sec.2,Cannng-nan Rd. Wu-chi Town Taichung Shien, Taiwan, R.O.C.

TEL:+886-4-26393976 FAX:+886-4-26393125

HUEY JANN High Power 10W LED is made of GaInN chips with precise package technique which makes excellent heat dissipation to reach the advantages of high luminous efficiency, low decay, and long endurance. Now we have these colors available: red, green, blue, white, yellow .

FEATERUS

- Instant light
- Long operating life
- Superior ESD defense
- Low voltage DC operated
- More energy efficient than incandescent and most halogen lamps

TYPICAL APPLICATIONS

- Architectural detail lighting
- Portable flashlight
- Reading lights
- Medical applications
- Beacon lights
- Decoration lights

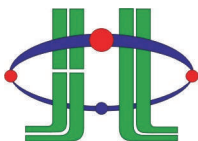

HUEY JANN ELECTRONICS INDUSTRY CO., LTD.

No.27 Line 466 Sec.2,Cannng-nan Rd. Wu-chi Town Taichung Shien, Taiwan, R.O.C.

TEL:+886-4-26393976 FAX:+886-4-26393125

Explanation of Part Number:

H P R 20 D - 1 9K 10 xWx
① ② ③ ④ ⑤ ⑥ ⑦ ⑧ ⑨

1.H: Huey Jann

2.P: High power LED Type

3.Shape distinguish:

4.Identification no:

R: Rectangular type

5.Lead frame type

6.Appearance:

1:White Diffusion

7.Color number:

8.Power type:

3K: Green

4K: Yellow

10: 10W

20: 20W

5K: Red

8K: Blue

9K: White

9.Color kind:

BW: Cool White

W: Pure White

NW: Nature White

YW: Warm White

BWG: Cool White

WG: Pure White

NWG: Nature White

YWG: Warm White

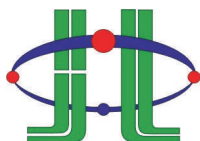

HUEY JANN ELECTRONICS INDUSTRY CO., LTD.

No.27 Line 466 Sec.2,Cannng-nan Rd. Wu-chi Town Taichung Shien, Taiwan, R.O.C.

TEL:+886-4-26393976 FAX:+886-4-26393125

DEVICES

Item	Lens Color	Dice Source	Color
HPR20D-19K10BW	White Diffusion	GaN/GaN	Cool White
HPR20D-19K10BWG			Cool White
HPR20D-19K10W			Pure White
HPR20D-19K10WG			Pure White
HPR20D-19K10NW			Nature White
HPR20D-19K10NWG			Nature White
HPR20D-19K10YW			Warm white
HPR20D-19K10YWG			Warm white

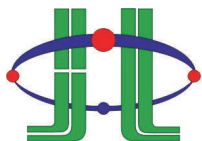

HUEY JANN ELECTRONICS INDUSTRY CO., LTD.

No.27 Line 466 Sec.2,Cannng-nan Rd. Wu-chi Town Taichung Shien, Taiwan, R.O.C.

TEL:+886-4-26393976 FAX:+886-4-26393125

PACKAGE DIMENSIONS:

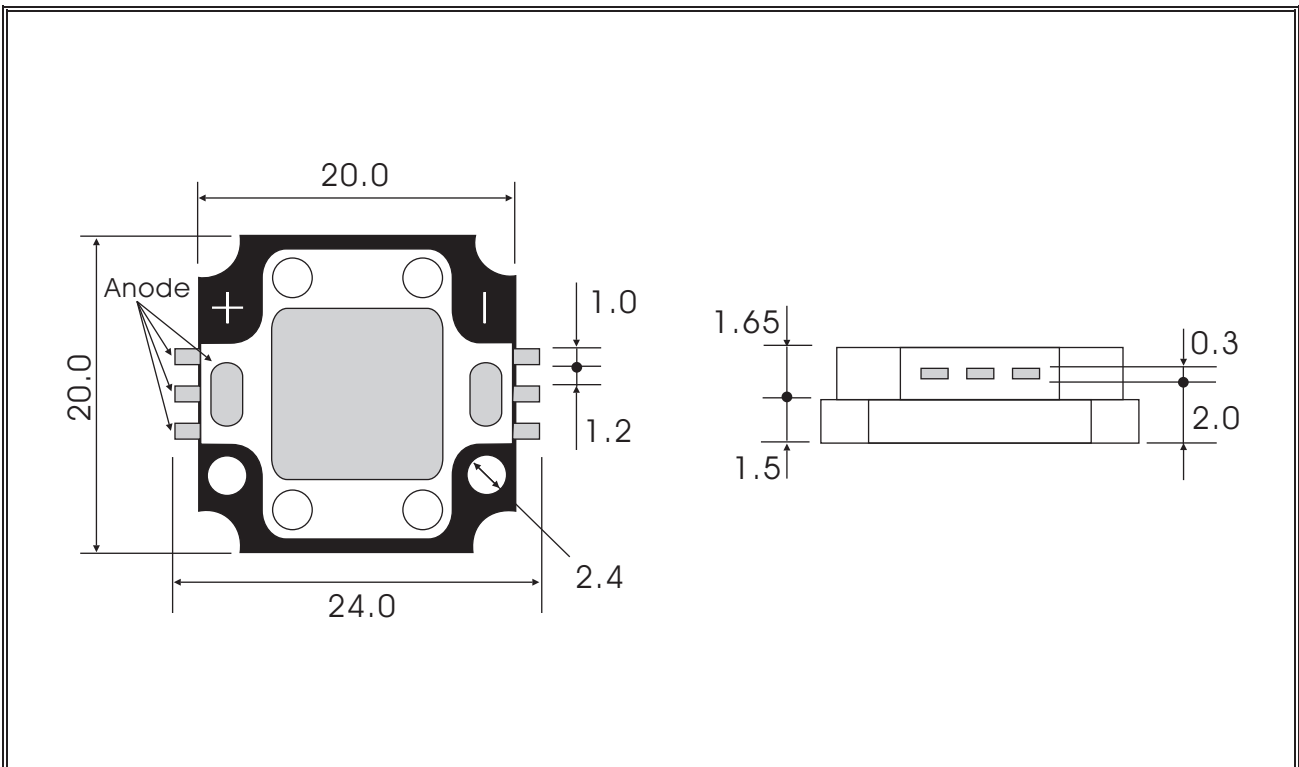

NOTE:

- 1.All dimensions are in millimeter.
- 2.Lead spacing in measured where the lead emerge from the package.
- 3.prodruded resin under flange is 1.5mm max.
- 4.specifications are subject to change without notice.
- 5.Tolerance is 0.3mm unless otherwise noted.
- 6.Driving LED without heat sinking device is forbidden.
- 7.It is strongly recommended that the temperature of lead be not higher than 55°C.
- 8.Proper current derating must be observed to maintain junction temperature below the maximum.
- 9.LEDs are not designed to be driven in reserve bias.
10. Warps the degree 0.5mm.

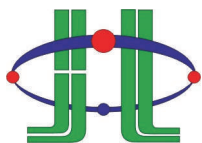

HUEY JANN ELECTRONICS INDUSTRY CO., LTD.

No.27 Line 466 Sec.2,Cannng-nan Rd. Wu-chi Town Taichung Shien, Taiwan, R.O.C.

TEL:+886-4-26393976 FAX:+886-4-26393125

ABSOLUTE MAXIMUM RATINGS

TA=25°C

PARAMETER	SYMBOL	MAX. RATING	UNIT
Continuous Forward Current	IF	700	mA
Peak Forward Current *1	IFM	1000	mA
Electrostatic Discharge (HBM)	ESD	4000	V
LED Junction Temperature	Tj	135	°C
Operating Temperature	Topr	-40 ~ +110	°C
Storage Temperature	Tstg	-40 ~ +120	°C
Manual Soldering Temperature 260 °C for 5 seconds max. *2			

*1.Duty Ratio=0.1%,Pulse Width=10us.

*2.Iron soldering high temperature will not cause damage to the dice. But be aware of the high temperature will not only make the epoxy soften but also cause the lead moving and the gold wire broken and even open. So before returning to the normal temperatures PLEASE AVOID any serious pressure on the top of epoxy and lead.

*3. We suggest using PWM (Pulse Width Modulation) for driving.

*4. It is recommended to use series as there are several 3pcs. If there are more than 5pcs, please use product with higher power.

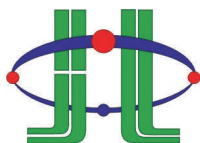

HUEY JANN ELECTRONICS INDUSTRY CO., LTD.

No.27 Line 466 Sec.2,Cannng-nan Rd. Wu-chi Town Taichung Shien, Taiwan, R.O.C.

TEL:+886-4-26393976 FAX:+886-4-26393125

ELECTRIC-OPTICAL CHARACTERISTICS

TA=25°C

PARAMETER	SYMBOL	TEST CONDITION	MIN	TYP	MAX	UNIT
View Angle of Half Power	2θ1/2	IF=700mA		120		deg
Forward Voltage	VF			14	16	V
Color Rendering Index	CRI			85		
Thermal Resistance Junction To Case	$R\theta_{J-C}$			4		°C/W
Temperature Coefficient Of Forward Voltage	$\Delta V_F/\Delta T$				-2	mV/°C

ELECTRIC-OPTICAL CHARACTERISTICS FOR LUMINOUS INTENSITY

TA=25°C

ITEM	SYMBOL	TEST CONDITION	MIN	TYP	MAX	UNIT
HPR20D-19K10BW	IV	IF=700mA		700		lm
HPR20D-19K10BWG				820		
HPR20D-19K10W				700		
HPR20D-19K10WG				820		
HPR20D-19K10NW				680		
HPR20D-19K10NWG				796		
HPR20D-19K10YW				630		
HPR20D-19K10YWG				738		

*Tolerance: 15% HUEY-JANN measuring equipment : EXELTRON 2001. 2.S370 made by U.D.T.

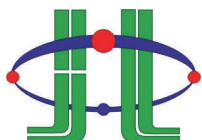

HUEY JANN ELECTRONICS INDUSTRY CO., LTD.

No.27 Line 466 Sec.2,Cannng-nan Rd. Wu-chi Town Taichung Shien, Taiwan, R.O.C.

TEL:+886-4-26393976 FAX:+886-4-26393125

ELECTRIC-OPTICAL CHARACTERISTICS FOR COLOR TEMPERATURE

TA=25°C

ITEM	SYMBOL	TEST CONDITION	MIN	TYP	MAX	UNIT
HPR20D-19K10BW	CCT	IF=700mA		8000		°K
HPR20D-19K10BWG				8000		
HPR20D-19K10W				6000		
HPR20D-19K10WG				6000		
HPR20D-19K10NW				4000		
HPR20D-19K10NWG				4000		
HPR20D-19K10YW				3300		
HPR20D-19K10YWG				3300		

*Tolerance: 15% HUEY-JANN measuring equipment : EXELTRON 2001. 2.S370 made by U.D.T.

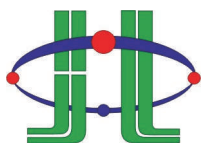

HUEY JANN ELECTRONICS INDUSTRY CO., LTD.

No.27 Line 466 Sec.2,Cannng-nan Rd. Wu-chi Town Taichung Shien, Taiwan, R.O.C.

TEL:+886-4-26393976 FAX:+886-4-26393125

RELIABILITY TEST

Endurance Test

Test Item	Reference Standard	Test Conditions	Result
Operation Life	MIL-STD-750:1026 MIL-STD-883:1005 JIS-C-7021 :B-1	Connect with a power if=700mA Ta=Under room temperature Test Time=1,000hrs	0/22
High Temperature High Humidity Storage	MIL-STD-202:103B JIS-C-7021 :B-11	Ta=+85°C 5°C RH=80% ~ 85% Test Time=1,000hrs	0/22
High Temperature Storage	MIL-STD-883:1008 JIS-C-7021 :B-10	High Ta=+120°C 5°C Test Time=1,000hrs	0/22
Low Temperature Storage	JIS-C-7021 :B-12	Low Ta=-40°C 5°C Test Time=1,000hrs	0/22

*Failure Criteria:

1. VF arise $\geq 10\%$
2. IV decline $\geq 30\%$
3. A failure is an LED that is open or shorted

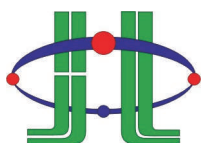

HUEY JANN ELECTRONICS INDUSTRY CO., LTD.

No.27 Line 466 Sec.2,Canng-nan Rd. Wu-chi Town Taichung Shien, Taiwan, R.O.C.

TEL:+886-4-26393976 FAX:+886-4-26393125

RELIABILITY TEST

➤ Environmental Test

Test Item	Reference Standard	Test Conditions	Result
Temperature Cycling	MIL-STD-202:107D MIL-STD-750:1051 MIL-STD-883:1010 JIS-C-7021 :A-4	-40°C ~ +25°C ~ +85°C ~ +25°C 60min 20min 60min 20min Test Time=200cycle	0/22
Thermal Shock	MIL-STD-202:107D MIL-STD-750:1051 MIL-STD-883:1010	-40°C 5°C ~ +110°C 5°C 20min 20min Test Time=200cycle	0/22

*Failure Criteria:

1. VF arise \geq 10%
2. IV decline \geq 30%
3. A failure is an LED that is open or shorted

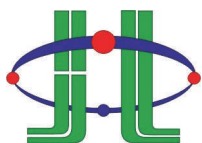

HUEY JANN ELECTRONICS INDUSTRY CO., LTD.

No.27 Line 466 Sec.2,Canng-nan Rd. Wu-chi Town Taichung Shien, Taiwan, R.O.C.

TEL:+886-4-26393976 FAX:+886-4-26393125

TYPICAL ELECTRICAL OPTICAL CHARACTERISTICS CURVES

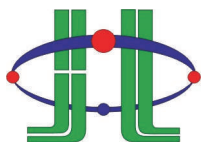
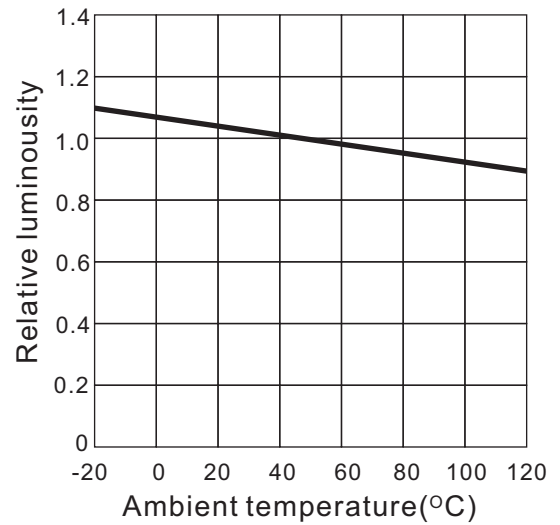
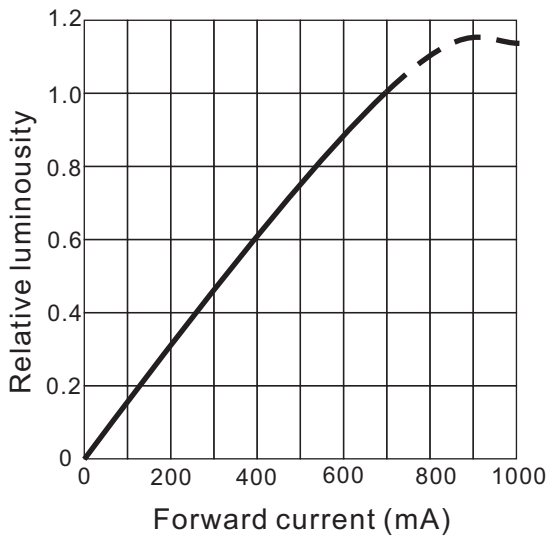
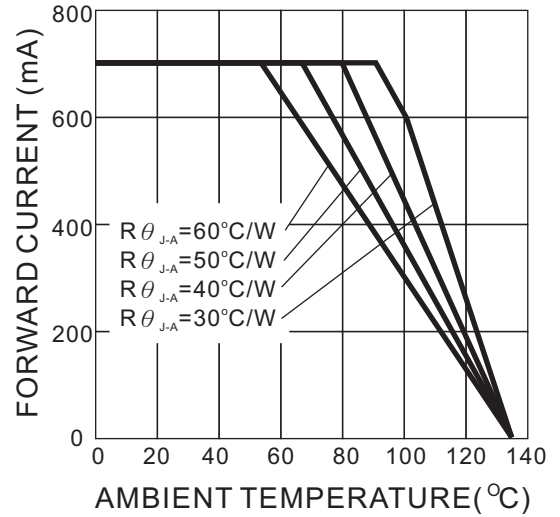
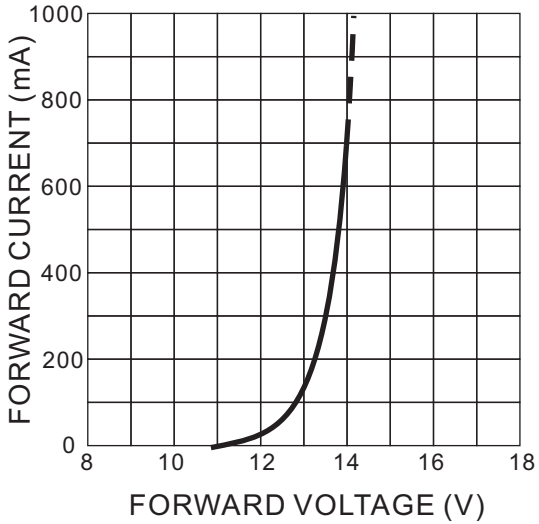

HUEY JANN ELECTRONICS INDUSTRY CO., LTD.

No.27 Line 466 Sec.2,Cannng-nan Rd. Wu-chi Town Taichung Shien, Taiwan, R.O.C.

TEL:+886-4-26393976 FAX:+886-4-26393125

TYPICAL ELECTRICAL OPTICAL CHARACTERISTICS CURVES

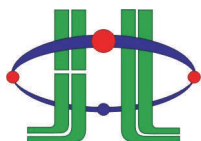
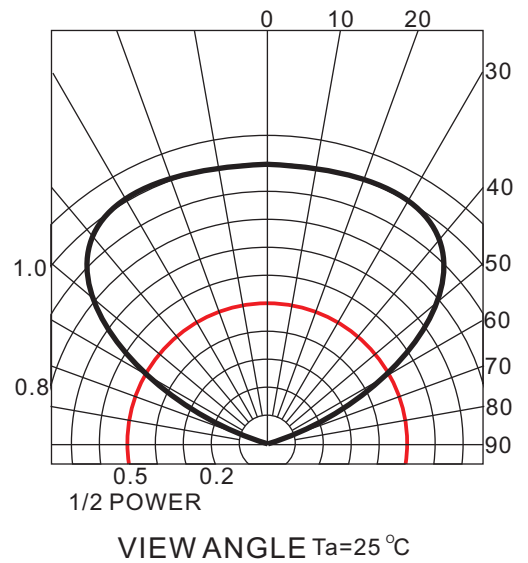
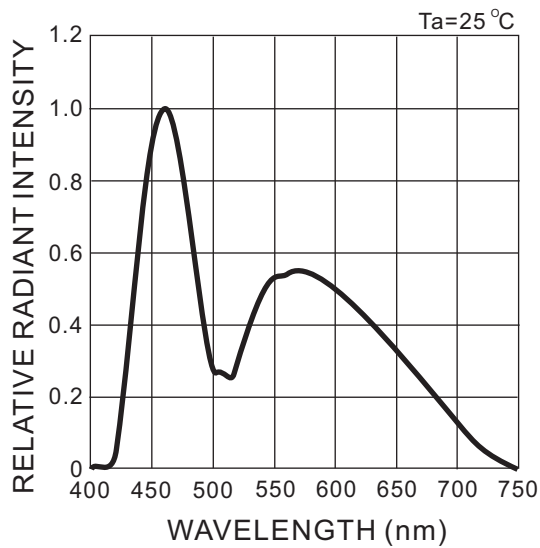
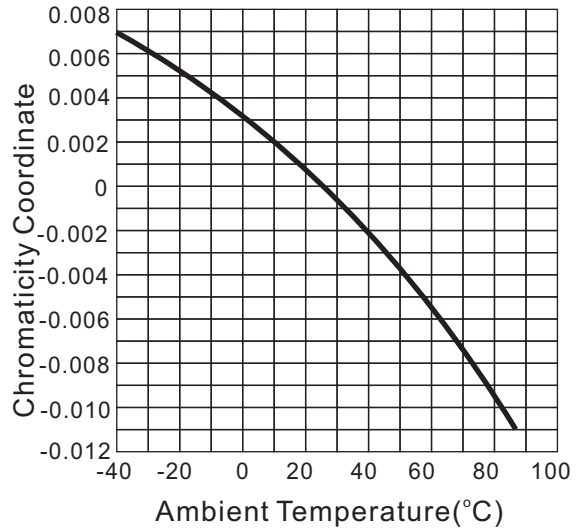
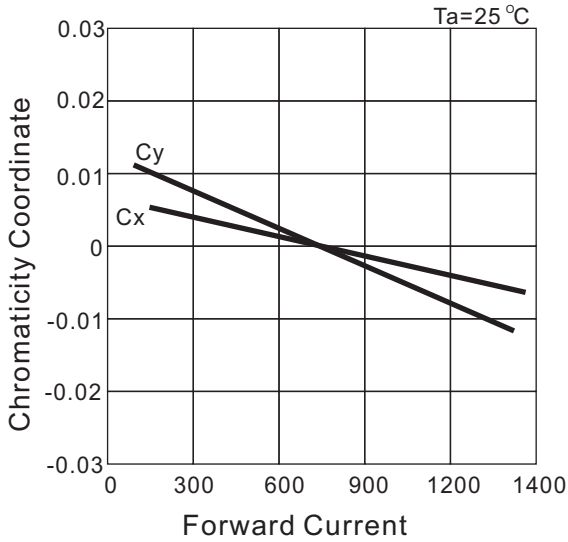

HUEY JANN ELECTRONICS INDUSTRY CO., LTD.

No.27 Line 466 Sec.2,Canng-nan Rd. Wu-chi Town Taichung Shien, Taiwan, R.O.C.

TEL:+886-4-26393976 FAX:+886-4-26393125

Cool White Color Bin Selection

CCT(°K)		Chromaticity Coordinates			
TYP					
8000	x	0.274	0.303	0.311	0.290
	y	0.301	0.333	0.293	0.270
Tolerance		$x \pm 0.02$		$y \pm 0.02$	

Cool White CIE Light Color Chart

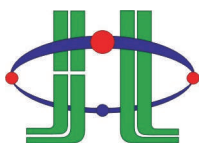
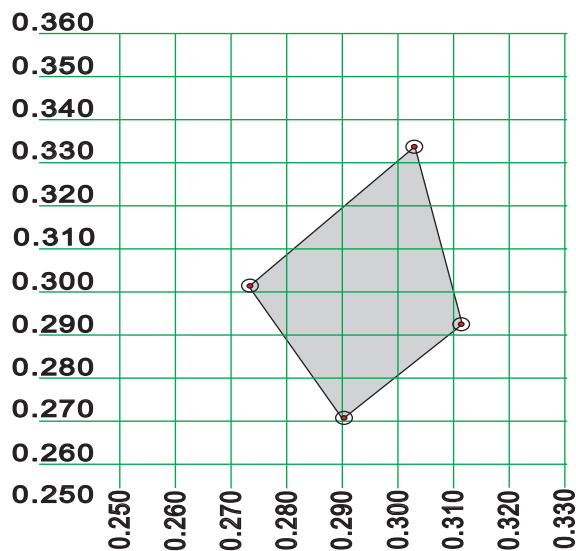

HUEY JANN ELECTRONICS INDUSTRY CO., LTD.

No.27 Line 466 Sec.2, Cannng-nan Rd. Wu-chi Town Taichung Shien, Taiwan, R.O.C.

TEL:+886-4-26393976 FAX:+886-4-26393125

Pure White Color Bin Selection

CCT(°K)		Chromaticity Coordinates			
TYP					
6000	x	0.301	0.329	0.329	0.311
	y	0.342	0.369	0.310	0.293
Tolerance		$x \pm 0.02$		$y \pm 0.02$	

Pure White CIE Light Color Chart

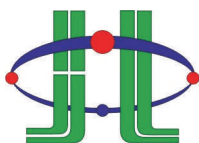
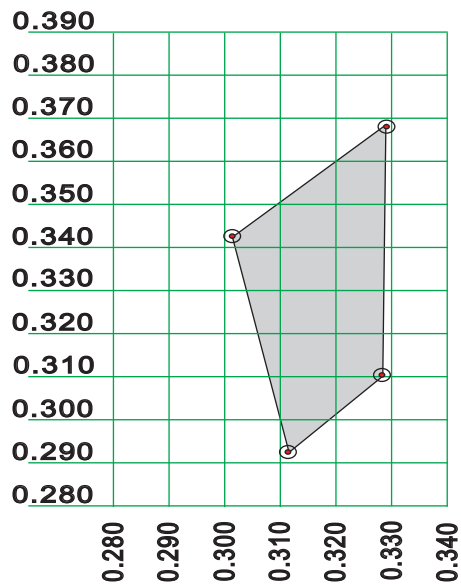

HUEY JANN ELECTRONICS INDUSTRY CO., LTD.

No.27 Line 466 Sec.2, Cangg-nan Rd. Wu-chi Town Taichung Shien, Taiwan, R.O.C.

TEL:+886-4-26393976 FAX:+886-4-26393125

☰ Nature White Color Bin Selection

CCT(°K)	Chromaticity Coordinates				
TYP					
4000	x	0.367	0.420	0.396	0.357
	y	0.400	0.432	0.367	0.342
Tolerance		$x \pm 0.02$		$y \pm 0.02$	

☰ Nature White CIE Light Color Chart

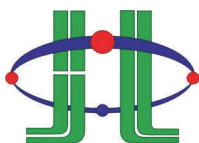
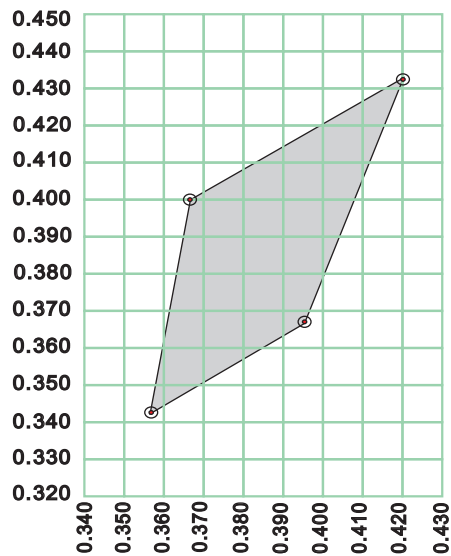

HUEY JANN ELECTRONICS INDUSTRY CO., LTD.

No.27 Line 466 Sec.2, Cangg-nan Rd. Wu-chi Town Taichung Shien, Taiwan, R.O.C.

TEL:+886-4-26393976 FAX:+886-4-26393125

Warm White Color Bin Selection

CCT(K)		Chromaticity Coordinates					
TYP		x					
3300	x	0.402	0.454	0.429	0.416	0.410	0.383
	y	0.423	0.446	0.394	0.389	0.374	0.360
Tolerance		$x \pm 0.02$			$y \pm 0.02$		

Warm White CIE Light Color Chart

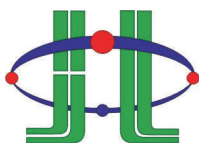
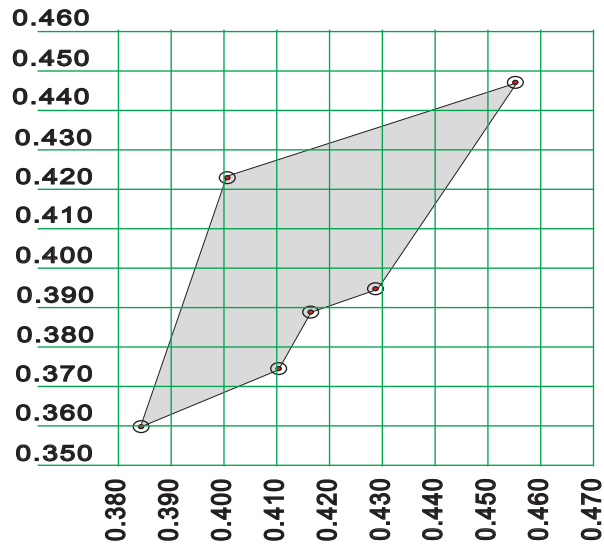

HUEY JANN ELECTRONICS INDUSTRY CO., LTD.

No.27 Line 466 Sec.2, Cangg-nan Rd. Wu-chi Town Taichung Shien, Taiwan, R.O.C.

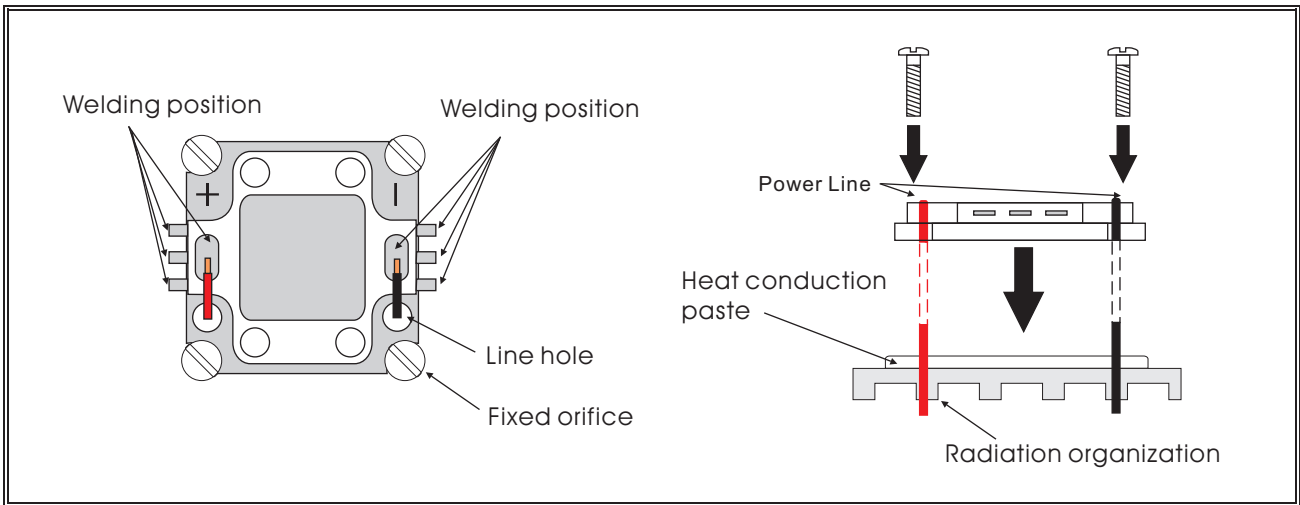

TEL:+886-4-26393976 FAX:+886-4-26393125

POSITION EXPLANATION:



Conclusion

Huey Jann provide simple comparison table for High Power LED, you could find your request heat dissipation area from the following table.

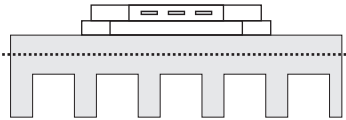
	 <p>Free Convection Horizontal Flat Heat Dissipation-Set-up (Area Require mm²)</p>	 <p>Free Convection Vertical Flat Heat Dissipation-Set-up (Area Require mm²)</p>	 <p>Free Convection Finned Heat Dissipation-Set-up (Area Require mm²)</p>
10W	13,500	10,000	46,500

*TAB in this table is according to highest operating temperature 65°C.

*Different materials of second heat dissipation device, the surface area of heat sink will be different. Thus, this document is for reference only.

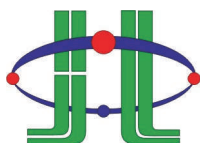

HUEY JANN ELECTRONICS INDUSTRY CO., LTD.

No.27 Line 466 Sec.2,Cannng-nan Rd. Wu-chi Town Taichung Shien, Taiwan, R.O.C.

TEL:+886-4-26393976 FAX:+886-4-26393125

PRODUCT APPLICATION

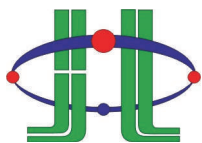
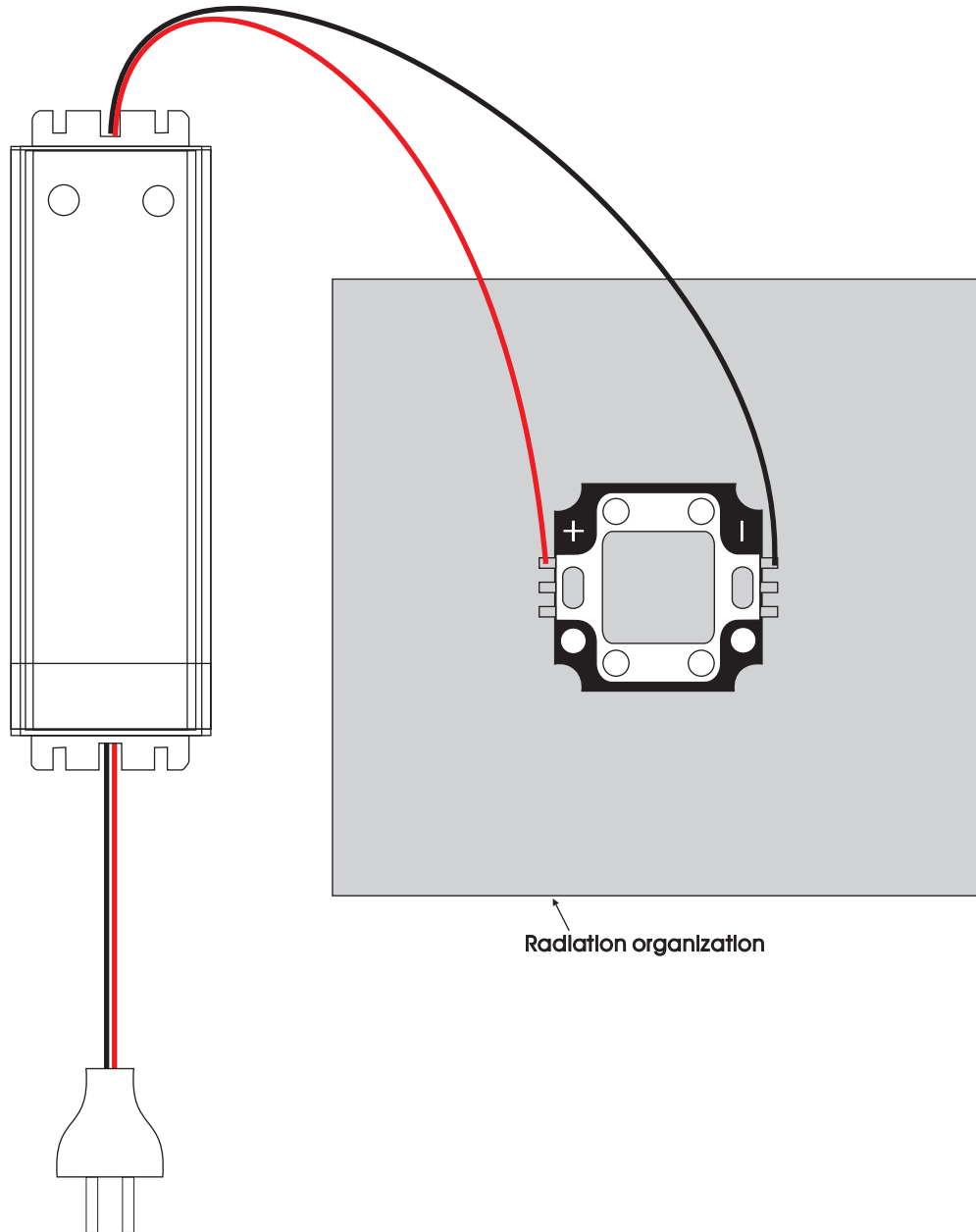

HUEY JANN ELECTRONICS INDUSTRY CO., LTD.

No.27 Line 466 Sec.2,Cang-nan Rd. Wu-chi Town Taichung Shien, Taiwan, R.O.C.

TEL:+886-4-26393976 FAX:+886-4-26393125

10W Operating Instructions

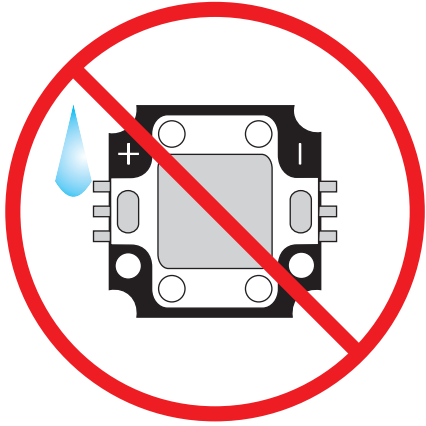

1. It is important to keep away the product from water, in order to avoid the product electronic characteristics to be harmful.

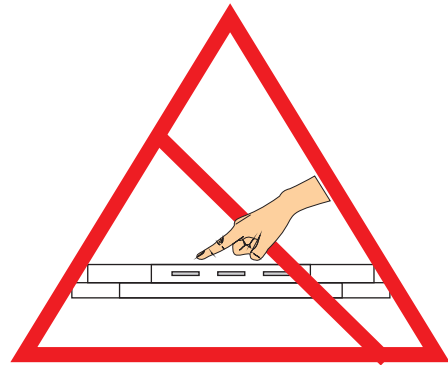

2. When making use of products, it is necessary to use anti-ESD devices to prevent destructive electronic characteristics.

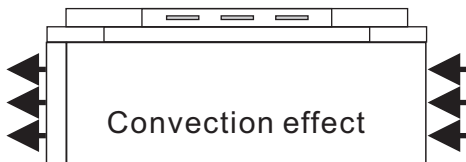

3. It should be noticed whether there is convection in design of device. Convection has to exist.

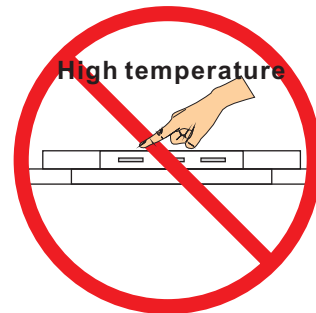

Above 150°C



4. There is 150 C directly from the front of 10W emitting diode. It is untouchable to prevent burning.

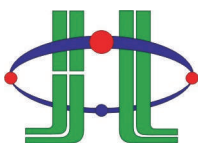

HUEY JANN ELECTRONICS INDUSTRY CO., LTD.

No.27 Line 466 Sec.2,Canng-nan Rd. Wu-chi Town Taichung Shien, Taiwan, R.O.C.

TEL:+886-4-26393976 FAX:+886-4-26393125

10W Operating Instructions

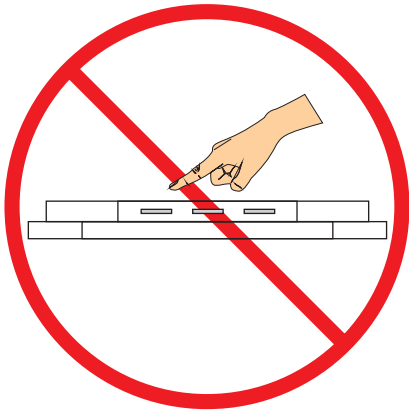

5. The material in the central top of 10W LED is soft. Therefore, it is un-squeezable and untouchable.

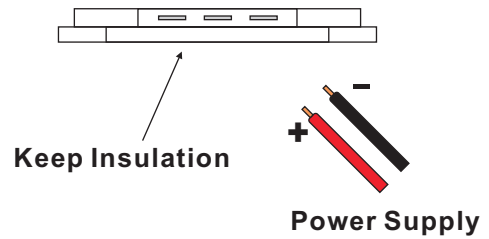

6. In the bottom of heat sink cannot be touched with neither positive nor negative pole. (Heat sink has to be insulation.)

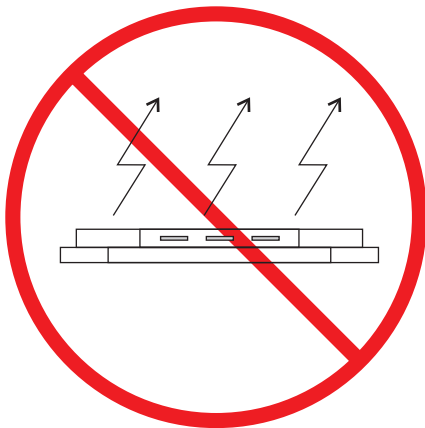

7. The product should not be light up directly without heat dissipation device.

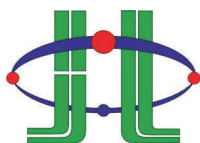

HUEY JANN ELECTRONICS INDUSTRY CO., LTD.

No.27 Line 466 Sec.2,Cannng-nan Rd. Wu-chi Town Taichung Shien, Taiwan, R.O.C.

TEL:+886-4-26393976 FAX:+886-4-26393125

TAB Temperature - Life Characteristics Curves

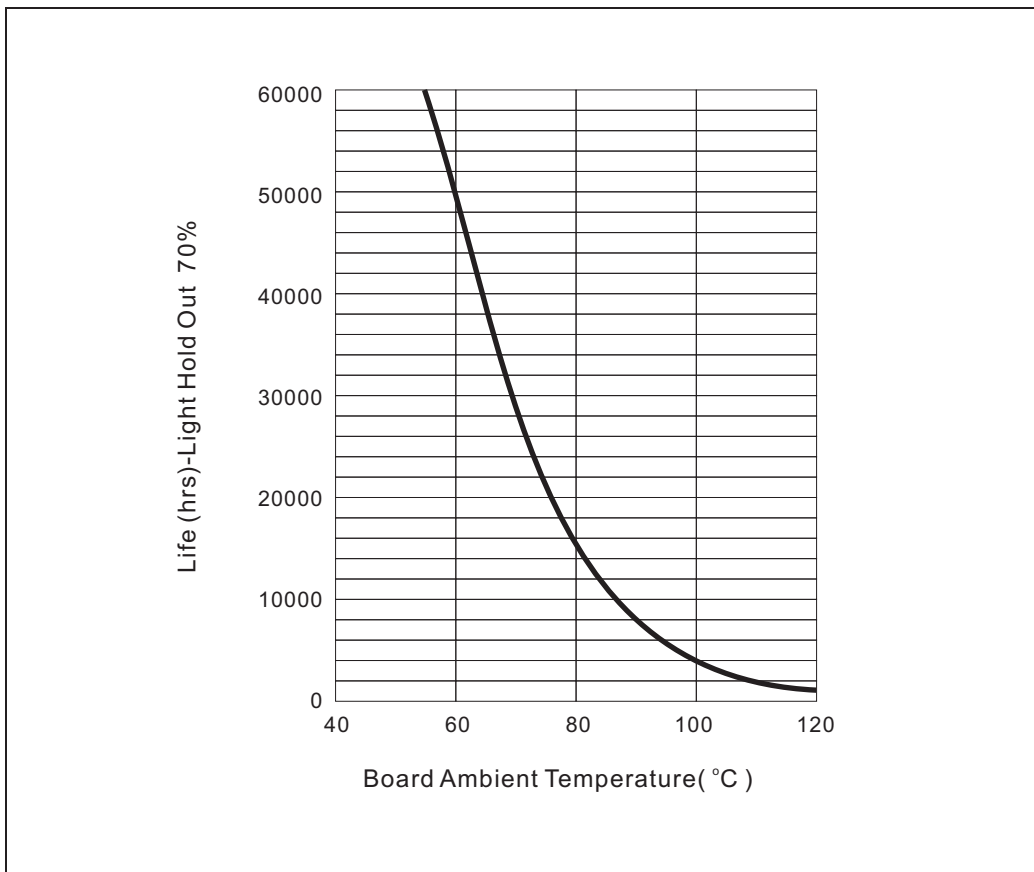
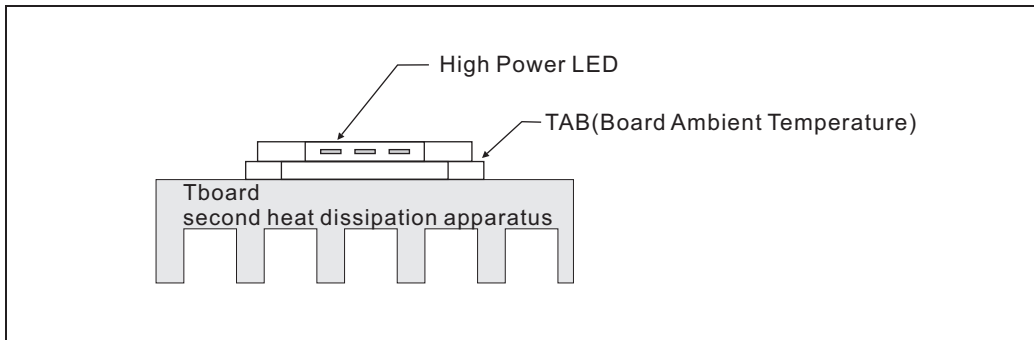

*Board Ambient Temperature Tolerance $\pm 5^{\circ}\text{C}$.

*The TAB is the stable testing value for the product lighted 100% after one hour.

*This document is for reference only.

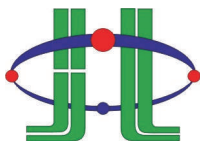

HUEY JANN ELECTRONICS INDUSTRY CO., LTD.

No.27 Line 466 Sec.2, Cangg-nan Rd. Wu-chi Town Taichung Shien, Taiwan, R.O.C.

TEL:+886-4-26393976 FAX:+886-4-26393125