



512K x 8 SRAM MODULE

SYS8512FKX-70/85/100/120

Issue 5.0: November 1999

Description

The SYS8512FKX is plastic 4M Static RAM Module housed in a standard 32 pin Dual-In-Line package organised as 512K x 8. The module utilises fast SRAMs housed in TSOP packages, and uses double sided surface mount techniques, buried decoder and dual board construction to achieve a very high density module.

The module has Chip Select, Write Enable and Output Enable control inputs; the Output Enable pin allows faster access times than address access during a Read Cycle.

Features

- Access Times of 70/85/100/120 ns.
- Low seated height
- 32 Pin 0.6" Dual-In-Line package with JEDEC compatible pinout.
- 5 Volt Supply \pm 10%.
- Low Power Dissipation:
Average (min cycle) 605mW (maximum).
Standby (CMOS) 44mW (maximum).
- Completely Static Operation.
- Equal Access and Cycle Times.
- All Inputs and Outputs Directly TTL Compatible.
- On-board Supply Decoupling Capacitors.

Block Diagram

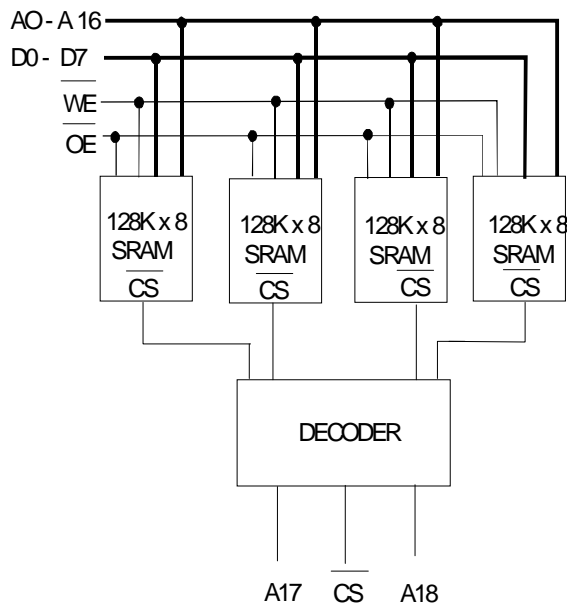

Pin Definition

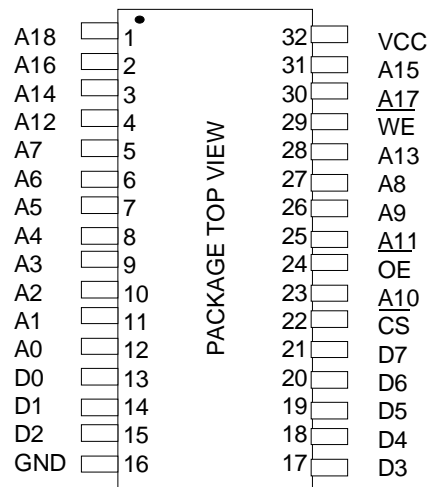

Pin Functions

- Address Inputs* **A0 - A18**
- Data Input/Output* **D0 - D7**
- Chip Select Input* **CS**
- Read/Write Input* **WE**
- Output Enable Input* **OE**
- Power (+5V)* **V_{CC}**
- Ground* **GND**

DC OPERATING CONDITIONS**Absolute Maximum Ratings** ⁽¹⁾

Parameter	Symbol	min	typ	max	unit
Voltage on any pin relative to V_{SS}	V_T	-0.3V	-	+7	V
Power Dissipation	P_T	-	1	-	W
Storage Temperature	T_{STG}	-55	-	+150	°C

Notes :

(1) Stresses above those listed may cause permanent damage to the device. This is a stress rating only and functional operation of the device at those or any other conditions above those indicated in the operational sections of this specification is not implied. Exposure to absolute maximum rating conditions for extended periods may affect device reliability.

(2) V_T can be -3.5V pulse of less than 20ns.

Recommended Operating Conditions

Parameter	Symbol	min	typ	max	unit
Supply Voltage	V_{CC}	4.5	5.0	5.5	V
Input High Voltage	V_{IH}	2.2	-	$V_{CC} + 0.3$	V
Input Low Voltage	V_{IL}	-0.3	-	0.8	V
Operating Temperature	T_A	0	-	70	°C
	T_{AI}	-40	-	85	°C (I)

DC Electrical Characteristics ($V_{CC}=5V\pm 10\%$) T_A 0 to 70°C

Parameter	Symbol	Test Condition	min	typ ⁽²⁾	max	Unit
I/P Leakage Current	A0~A16, OE	I_{LI} $0V - V_{IN} - V_{CC}$	-	-	±8	µA
Output Leakage Current	D0~D7	I_{LO} $\overline{CS} = V_{IH}, V_{IO} = GND \text{ to } V_{CC}$	-	-	±8	µA
Operating Supply Current	I_{CC}	$\overline{CS} = V_{IL}, I_{IO} = 0mA, V_{IL} - V_{IN} - V_{CC} - 2.1V$	-	16	45	mA
Average Supply Current	TTL levels	I_{CC1} Min. Cycle, $\overline{CS} = V_{IL}, V_{IN} = V_{IL}/V_{CC} - 2.1V$	-	70	110	mA
	CMOS levels	I_{CC2} Min. Cycle, $\overline{CS} - 0.2V, V_{IN} = 0.2V/V_{CC} - 0.2V$	-	24	40	mA
Standby Supply Current	TTL levels	I_{SB} $\overline{CS}, A17-A18 = V_{CC} - 2.1V, V_{IL} - V_{IN} - V_{CC} - 2.1V$	-	5	12	mA
	CMOS levels	I_{SB1} $\overline{CS}, A17-A18 = V_{CC} - 0.2V, 0.2 - V_{IN} - V_{CC} - 0.2V$	-	0.2	8	mA
	-L Part	I_{SB2} As above	-	10	500	µA
Output Voltage	V_{OL}	$I_{OL} = 2.1mA$	-	-	0.4	V
	V_{OH}	$I_{OH} = -1.0mA$	2.4	-	-	V

Typical values are at $V_{CC}=5.0V, T_A=25^\circ C$ and specified loading.

Capacitance ($V_{CC}=5V\pm 10\%$, $T_A=25^\circ C$)

Note: Capacitance calculated, not measured.

Parameter	Symbol	Test Condition	max	Unit
Input Capacitance (\overline{CS} , A17, A18)	C_{IN1}	$V_{IN} = 0V$	10	pF
I/P Capacitance (other)	C_{IN2}	$V_{IN} = 0V$	40	pF
I/O Capacitance	$C_{I/O}$	$V_{I/O} = 0V$	40	pF

Operation Truth Table

\overline{CS}	\overline{OE}	\overline{WE}	DATA PINS	SUPPLY CURRENT	MODE
H	X	X	High Impedance	I_{SB1}, I_{SB2}	Standby
L	L	H	Data Out	I_{CC1}, I_{CC2}	Read
L	L	L	Data In	I_{CC1}, I_{CC2}	Write
L	H	L	Data In	I_{CC1}, I_{CC2}	Write

Notes : H = V_{IH} : L = V_{IL} : X = V_{IH} or V_{IL} **Low V_{CC} Data Retention Characteristics - L Version Only**

Parameter	Symbol	Test Condition	-L Part		
			min	typ ⁽¹⁾	max
V_{CC} for Data Retention	V_{DR}	$\overline{CS} - V_{CC} - 0.2V$	2.0	-	-
Data Retention Current		$V_{CC} = 3.0V, \overline{CS} = V_{CC} - 0.2V$			
	I_{CCDR2}	$T_{OP} = 0C \text{ to } 70C$	-	9	230
	I_{CCDR3}	$T_{OP} = T_{AI}$	-	-	310
Chip Deselect to					
Data Retention Time	t_{CDR}	See Retention Waveform	0	-	-
Operation Recovery Time	t_R	See Retention Waveform	5	-	-

Notes (1) Typical figures are measured at 25°C.

(2) This parameter is guaranteed not tested.

AC Test Conditions**Output Load**

- * Input pulse levels: 0V to 3.0V
- * Input rise and fall times: 5ns
- * Input and Output timing reference levels: 1.5V
- * Output load: see diagram
- * $V_{CC}=5V\pm 10\%$

AC OPERATING CONDITIONS**Read Cycle**

<i>Parameter</i>	<i>Symbol</i>	<i>-70</i>		<i>-85</i>		<i>-10</i>		<i>-12</i>		<i>Unit</i>
		<i>min</i>	<i>max</i>	<i>min</i>	<i>max</i>	<i>min</i>	<i>max</i>	<i>min</i>	<i>max</i>	
Read Cycle Time	t_{RC}	70	-	85	-	100	-	120	-	ns
Address Access Time	t_{AA}	-	70	-	85	-	100	-	120	ns
Chip Select Access Time	t_{ACS}	-	70	-	85	-	100	-	120	ns
Output Enable to Output Valid	t_{OE}	-	50	-	55	-	60	-	70	ns
Output Hold from Address Change	t_{OH}	10	-	10	-	10	-	10	-	ns
Chip Selection to Output in Low Z	t_{CLZ}	10	-	10	-	10	-	10	-	ns
Output Enable to Output in Low Z	t_{OLZ}	5	-	5	-	5	-	5	-	ns
Chip Deselection to O/P in High Z	t_{CHZ}	0	25	0	30	0	35	0	45	ns
Output Disable to Output in High Z	t_{OHZ}	0	25	0	30	0	35	0	45	ns

Notes. (1) t_{HZ} and t_{OHZ} are defined as the time at which the outputs achieve open circuit conditions and are not referenced to output voltage levels. These parameters are sampled and not 100% tested.

Write Cycle

<i>Parameter</i>	<i>Sym</i>	<i>-70</i>		<i>-85</i>		<i>-10</i>		<i>-12</i>		<i>Unit</i>
		<i>min</i>	<i>max</i>	<i>min</i>	<i>max</i>	<i>min</i>	<i>max</i>	<i>min</i>	<i>max</i>	
Write Cycle Time	t_{WC}	70	-	85	-	100	-	120	-	ns
Chip Selection to End of Write	t_{CW}	60	-	80	-	90	-	100	-	ns
Address Valid to End of Write	t_{AW}	60	-	80	-	90	-	100	-	ns
Address Setup Time	t_{AS}	0	-	0	-	0	-	0	-	ns
Write Pulse Width	t_{WP}	55	-	65	-	75	-	85	-	ns
Write Recovery Time	t_{WR}	5	-	5	-	10	-	10	-	ns
Write to Output in High Z	$t_{WHZ}^{(11)}$	0	25	0	30	0	35	0	40	ns
Data to Write Time Overlap	t_{DW}	30	-	35	-	40	-	45	-	ns
Data Hold from Write Time	t_{DH}	0	-	0	-	0	-	0	-	ns
Output active from end of write	$t_{OW}^{(10)}$	5	-	5	-	5	-	5	-	ns

Read Cycle Timing Waveform ^(1,2)

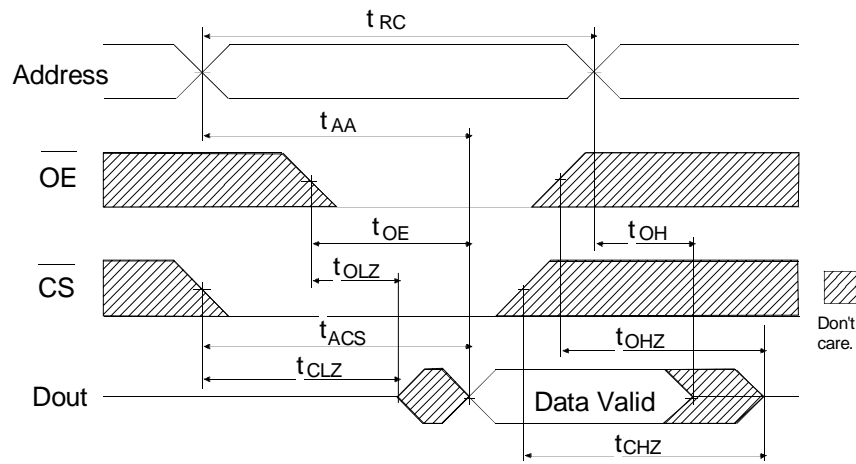

Notes (1) WE is High for Read Cycle.

(2) t_{HZ} and t_{OHZ} are defined as the time at which the outputs achieve open circuit conditions and are not referenced to output voltage levels. These parameters are sampled and not 100% tested.

Write Cycle No.1 Timing Waveform

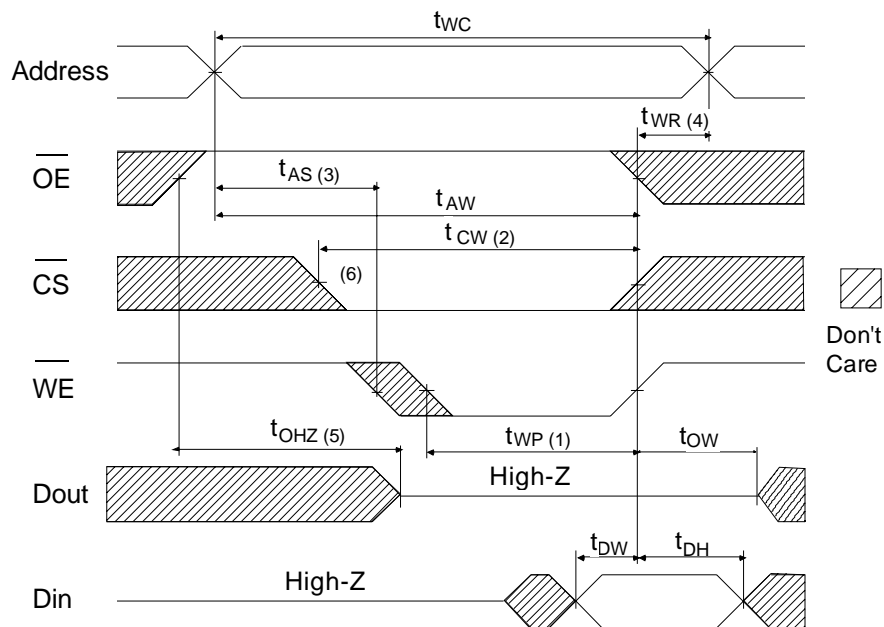

Write Cycle No.2 Timing Waveform

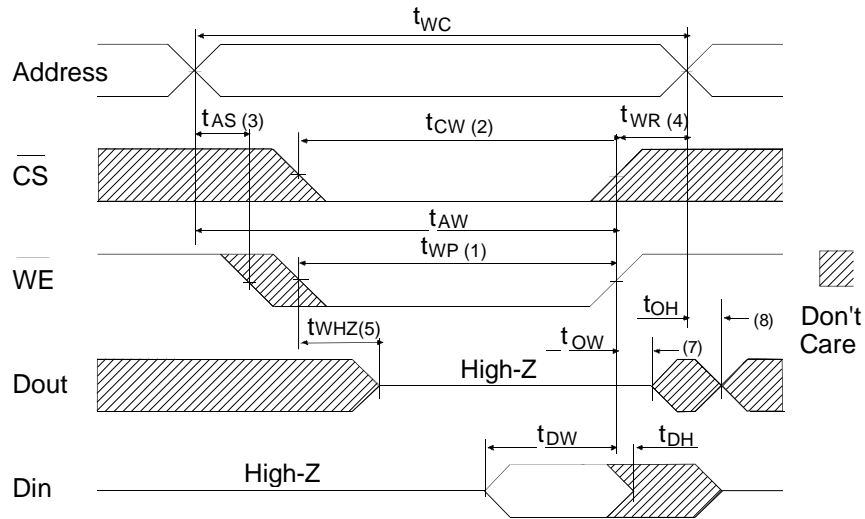

AC Characteristics Notes

- (1) A write occurs during the overlap (t_{WP}) of a low \overline{CS} and a low \overline{WE} .
- (2) t_{CW} is measured from the earlier of \overline{CS} or \overline{WE} going high to the end of write cycle.
- (3) t_{AS} is measured from the address valid to the beginning of write.
- (4) t_{WR} is measured from the earliest of \overline{CS} or \overline{WE} going high to the end of write.
- (5) During this period, I/O pins are in the output state. Input signals out of phase must not be applied.
- (6) If \overline{CS} goes low simultaneously with \overline{WE} going low or after \overline{WE} going low, outputs remain in a high impedance state.
- (7) D_{OUT} is in the same phase as written data of this write cycle.
- (8) D_{OUT} is the read data of next address.
- (9) If \overline{CS} is low during this period, I/O pins are in the output state, and inputs out of phase must not be applied to I/O pins.
- (10) This parameter is sampled and not 100% tested.
- (11) t_{WHZ} is defined as the time at which the outputs achieve open circuit conditions and is not referenced to output voltage levels. This parameter is sampled and not 100% tested.

Data Retention Waveform

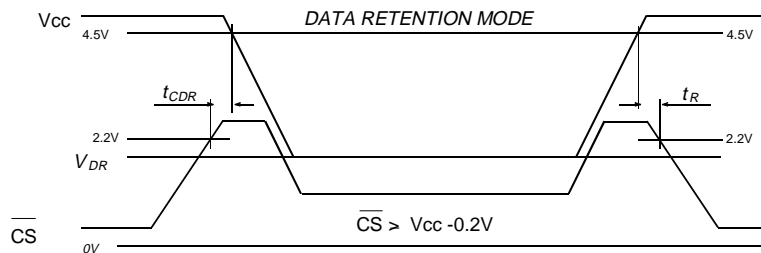

Package Information

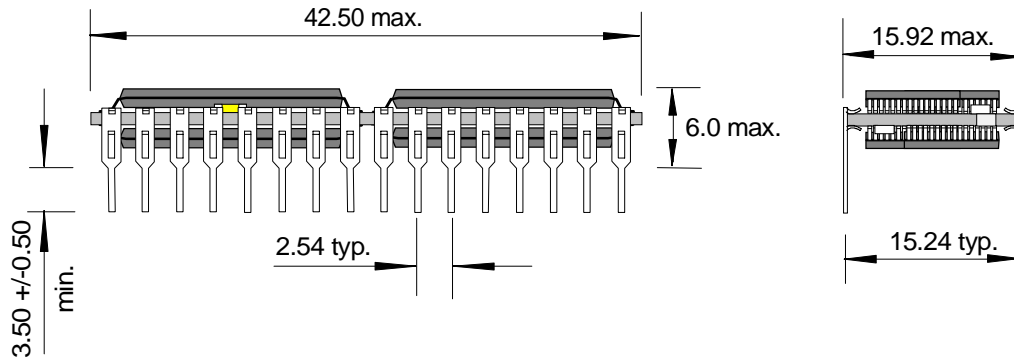

Dimensions in mm

Ordering Information

SYS8512FKXLI-10

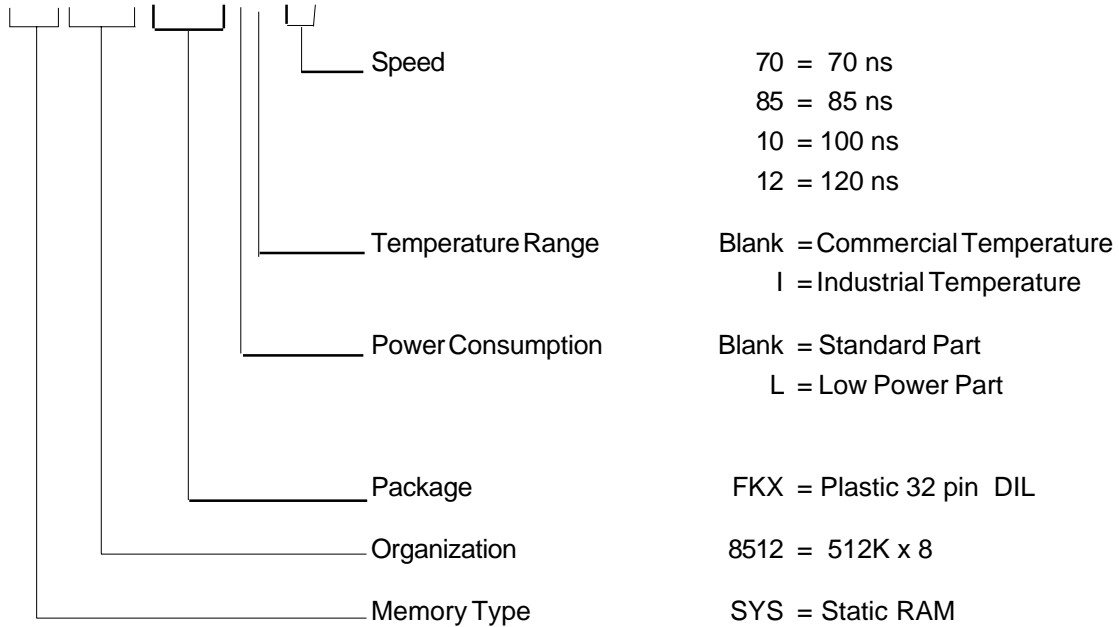

Although this data is believed to be accurate the information contained herein is not intended to and does not create any warranty of merchantability or fitness for a particular purpose. Our Products are subject to a constant process of development. Data may be changed at any time without notice. Products are not authorised for use as critical components in life support devices without the express approval of a company director.